

PARTS CATALOGUE



SCOOTERS

SBA1BA(RO)

AK550 ST



Release Date : 2023/06/11
Print Date : 2024/07/06

ABOUT THIS PARTS LIST

- This parts list is compiled all service parts for model SBA1BA(RO).
- Any difference between color chart and motorcycle will be revised according to motorcycle.
- The Mark:
 1. Marking "***" must add color code in the end before ordering parts.
 2. Marking "#" are parts with modification, Please find the details from e-Parts system.
- When modification or additions to this parts list are made a revised edition at an appropriate time.



CONTENTS

● ABOUT THIS PARTS LIST	1
● COLOR CHART OF SBA1BA(RO)	3
● CONTENTS-ENGINE GROUP	8
● CONTENTS-FRAME GROUP	10
● ENGINE PARTS LIST	13
● FRAME PARTS LIST	55
● PART NO. INDEX	147

NO	MODEL			COLOR CHART OF SBA1BA(RO)			
	PHOTO NO			NO. 1	NO. 2	NO. 3	
	BASIC COLOR			Cerulean Blue	Black	Flat Brown	
	CODE			Cerulean Blue	Black	Flat Brown	
	PARTS NAME	PARTS NO.	VERSION	WB419PA	NH001SA	YR392FA	
1	FENDER A FRONT	61100-LGC6-E00	5	DLG	D02	DKY	
2	ARM R PILLION STEP	50710-ACH6-900	3	HJA			
3	ARM L PILLION STEP	50720-ACH6-900	3				
4	COVER A R SIDE	83530-AKB8-E00	0	HJP			
5	COVER A L SIDE	83630-AKB8-E00	0				
6	CALIPER ASSY RR	43100-LGC6-E01	7	J2A			
7	BRACKET ASSY RR	43210-LGC6-305	0				
8	TOP COVER HANDLE	53207-AKB8-E00	7				
9	MOLDING B R SIDE	64312-AKB8-E00	0	JDP			
10	MOLDING B L SIDE	64313-AKB8-E00	0				
11	WHEEL SET RR	42600-LGC6-305	0	JEA			
12	WHEEL ASSY FR	44600-LGC6-305	0				
13	OUTER RS HEAD LIGHT	33109-AKB8-E00	0	JEP			
14	MOLDING C R SIDE	64202-AKB8-E00	0	JEP	JHP	JEP	
15	MOLDING C L SIDE	64203-AKB8-E00	0				
16	LEG SHIELD UP	81131-AKB8-E00	0	JJP			
17	LEG SHIELD MID	81142-AKB8-E00	0				
18	CALIPER ASSY FR L	45100-LGC6-E00	0	JTA			
19	CALIPER ASSY FR R	45200-LGC6-E00	0				
20	COVER A FRONT	64301-AKB8-E00	0				
21	MOLDING A R SIDE	64302-AKB8-E00	0				
22	MOLDING A L SIDE	64303-AKB8-E00	0				
23	COVER R BODY	83500-AKB8-E00	0				
24	BOARD B R SIDE	83510-AKB8-E00	0				
25	COVER A L BODY	83600-AKB8-E00	0	APP	N1P	ZBP	
DATE OF STARTING-SALES							
DATE OF END-SALES							

NO	MODEL			COLOR CHART OF SBA1BA(RO)			
	PHOTO NO			NO. 1	NO. 2	NO. 3	
	BASIC COLOR			Cerulean Blue	Black	Flat Brown	
	CODE			Cerulean Blue	Black	Flat Brown	
	PARTS NAME	PARTS NO.	VERSION	WB419PA	NH001SA	YR392FA	
26	BOARD B L SIDE	83610-AKB8-E00	0	APP	N1P	ZBP	
27	LIDFUEL CAP MAINT	80152-AKB8-E00	7	N1P			
28	COVER FUEL	80154-AKB8-E00	8				
29	COVER COMP. L COVER	1134B-LGC6-E00	9				
30	COVER COMP. R	11630-LGC6-E00	9				
31	COVERRADIATOR	19025-LGC6-E00	2				
32	COVER UP ACHAIN	40510-LGC6-E00	5				
33	COVER UP B CHAIN	40511-LGC6-E01	2				
34	COVER LOW A CHAIN	40520-LGC6-E00	1				
35	COVER LOW B CHAIN	40521-LGC6-E00	1				
36	CASE BATTERY (Black)	50325-AKB8-E01	0				N1R
37	COVER UNDER	50613-AKB8-E00	0				
38	COVER FR MERTER	53203-AKB8-E00	6				
39	COVER METER	53204-AKB8-E00	0				
40	COVER HANDLE UP	53205-AKB8-E00	0				
41	COVER HANDLE LOW	53206-AKB8-E00	0				
42	FENDER FRONT INNER	61110-AKB8-E00	0				
43	COVER A,R WIND	64140-AKB8-E00	0				
44	RUBBER R WIND	64150-AKB8-E00	0				
45	COVER A L WIND	64240-AKB8-E00	0				
46	RUBBER L WIND	64250-AKB8-E00	0				
47	SKIRT R SIDE	64305-AKB8-E00	0				
48	SKIRT L SIDE	64306-AKB8-E00	0				
49	LID RESERVE TANK	64311-AKB8-E00	0				
50	MAT R FLOOR	64320-AKB8-E00	0				
DATE OF STARTING-SALES							
DATE OF END-SALES							

NO	MODEL			COLOR CHART OF SBA1BA(RO)					
	PHOTO NO			NO. 1	NO. 2	NO. 3			
	BASIC COLOR			Cerulean Blue	Black	Flat Brown			
	CODE			Cerulean Blue	Black	Flat Brown			
	PARTS NAME	PARTS NO.	VERSION	WB419PA	NH001SA	YR392FA			
51	PANEL A L FLOOR	64330-AKB8-E00	0	N1R					
52	MAT L FLOOR	64340-AKB8-E00	0						
53	MAT R LEG SHIELD	64350-AKB8-E00	0						
54	MAT L LEG SHIELD	64360-AKB8-E00	0						
55	PANEL B ASSY R	64370-AKB8-E00	0						
56	PANEL B ASSY L	64380-AKB8-E00	0						
57	FENDER RR TIRE	80100-LGC6-E00	3						
58	FENDER RR INNER	80101-AKB8-E00	5						
59	FENDER A REAR	80105-AKB8-E00	0						
60	FENDER B REAR	80106-AKB8-E00	0						
61	COVER B R BODY	83501-AKB8-E00	0						
62	COVER CR BODY	83502-AKB8-E00	0						
63	BOARD A ASSY R SIDE	83520-AKB8-E00	5						
64	BOARD C R SIDE	83540-AKB8-E00	7						
65	COVER C R SID	83550-AKB8-E00	7						
66	COVER B ASSY L BODY	83601-AKB8-E00	0						
67	COVER C L BODY	83602-AKB8-E00	0						
68	BOARD A ASSY L SID	83620-AKB8-E00	5						
69	BOARD C L SIDE	83640-AKB8-E00	7						
70	COVER C L SIDE	83650-AKB8-E00	7						
71	COVER RR CENTER	83750-AKB8-E00	0						
72	BAND HARNESS WIRE	90656-KUDU-900	0						
73	SPROCKET DRIVEN	41201-AGJ5-E00	2				NEA		
74	HOLDER RR CALIPER	43110-LGC6-E00	5						
75	CYLN SET RR MASTER	43530-AGJ5-305	0						
DATE OF STARTING-SALES									
DATE OF END-SALES									

NO	MODEL			COLOR CHART OF SBA1BA(RO)			
	PHOTO NO			NO. 1	NO. 2	NO. 3	
	BASIC COLOR			Cerulean Blue	Black	Flat Brown	
	CODE			Cerulean Blue	Black	Flat Brown	
	PARTS NAME	PARTS NO.	VERSION	WB419PA	NH001SA	YR392FA	
76	STAY FR FENDER R	51421-LGC6-E00	4	NEA			
77	STAY FR FENDER L	51521-LGC6-E00	4				
78	FENDER COVER R SIDE	61101-AKB8-E00	0				
79	FENDER COVER L SIDE	61102-AKB8-E00	0	NEP			
80	GRIP COMP RR	81200-AKB8-E00	3				
81	CAP ACG	90084-4H28-001	1	NJA			
82	FORK ASSY RR L/H	52100-AKB8-E00	0				
83	FORK CAST RR R/H	52120-AKB8-E00	0				
84	HOLDER ASSY FINAL	52130-AKB8-E00	0				
85	WIND SCRRN ASSY	6422A-AKB8-E00	0				
86	SEAT ASSY	77200-AKB8-309	0				
87	EMB K-LOGO	86102-LGC6-E00	5				
88	EMB AK LOGO	86202-AKB8-E00	0				
89	STRIPE R PREMIUM	86221-AKB8-E01	3				
90	STRIPE L PREMIUM	86231-AKB8-E01	3	T01			
91	STRIPE AIBS R FR	86282-AKB8-E00	4				
92	STRIPE L AIBS FR MOLD	86283-AKB8-E00	4				
93	EMB SIDE MOLD	86380-LGC6-E00	2				
94	STRIPE WHEEL	86430-AKB8-E00	0				
95	CAUTION LABEL	87515-LGC6-E00	2				
96	NOTICE MOBILE PHONE	87541-ZZA6-E00	2				
97	LABEL FUEL TANK	87546-ADG5-E00	2				
98	MARK DRIVER CAUTION	87560-LGC6-E00	2				
99	EMB HANDLE COVER	86020-AKB8-E00	0	T02	T01	T02	
100	EMB KYMCO ASSY.	8620A-LGC6-E00	3	T02			
DATE OF STARTING-SALES							
DATE OF END-SALES							

CONTENTS - ENGINE GROUP

E01 Crank Case

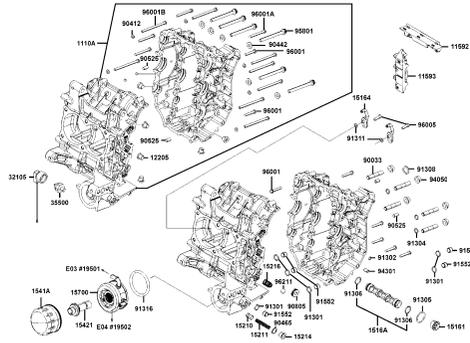

E02 Cylinder Head Cover Cylinder

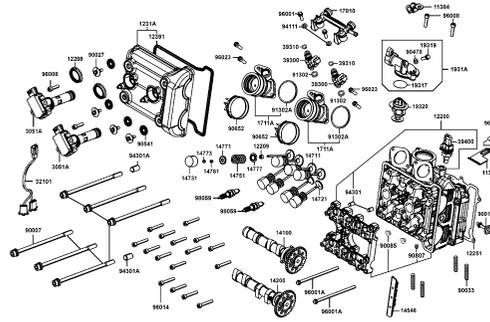

E03 Cylinder Piston

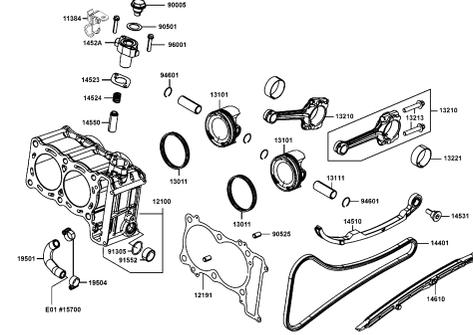

E04 Left Side Cover Water Pump

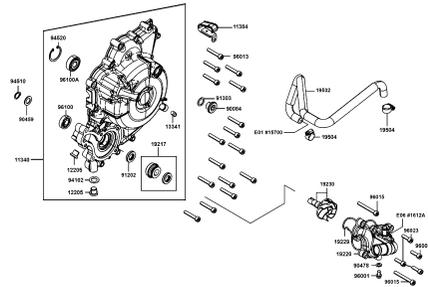

E05 Right Crankcase Cover Shaft

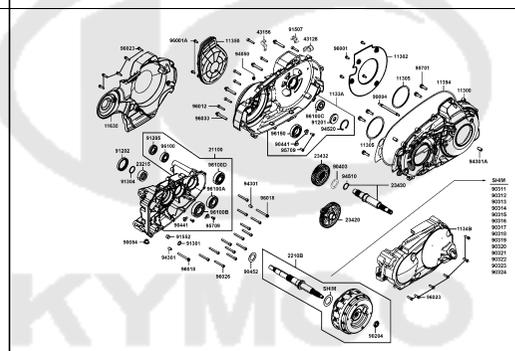

E06 Throttle Body

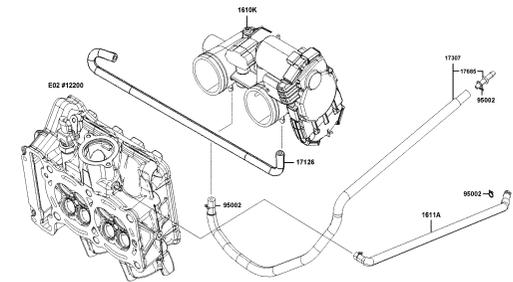

E07 Transmission Pulley

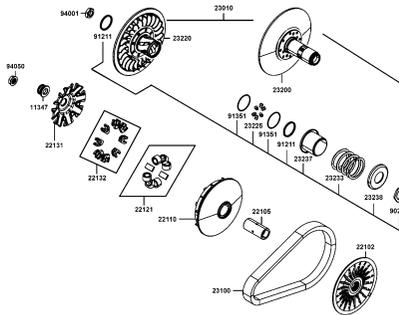

E08 Starting Motor Generator

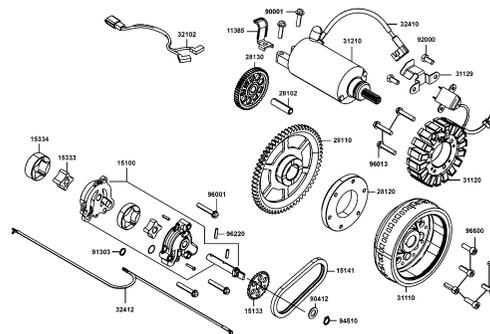

E09 Crank Shaft Drive Procket

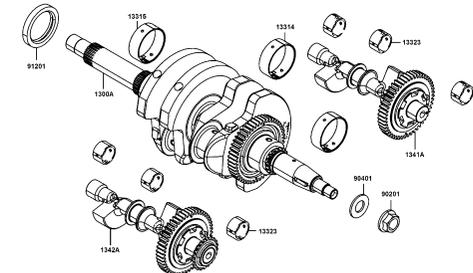

CONTENTS - ENGINE GROUP

E10 CASE COMP L MISSION

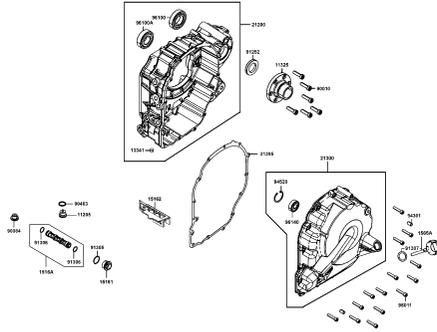

E01

Crank Case

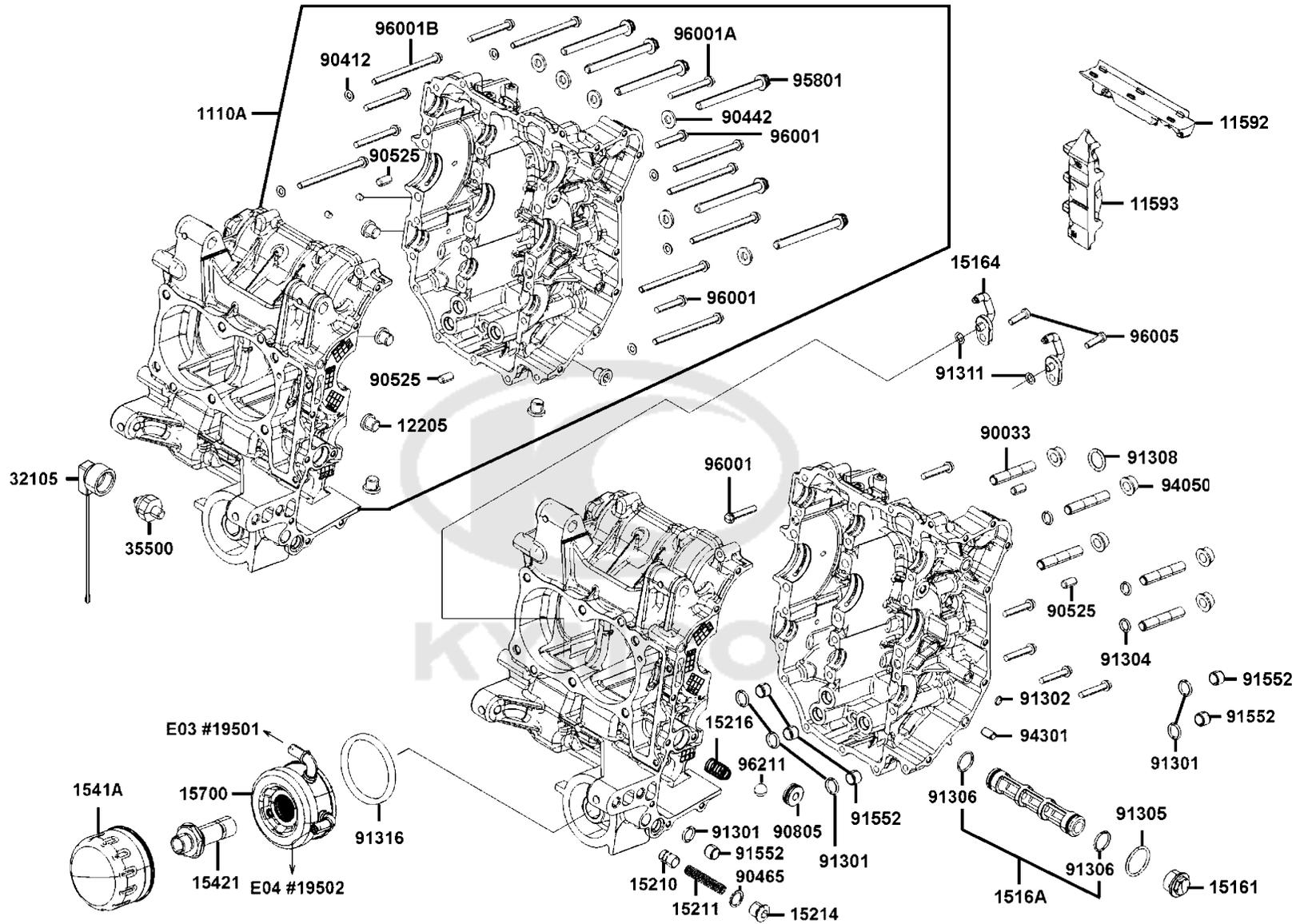

Sales mark	Ref no	Part no	Description	Reg description	Regd no	E01
	1110A	1110A-LGC6-E00	CRANKCASE ASSEMBLY	CRANKCASE ASSEMBLY	1	
	11592	11592-LGC6-E00	RUBBER B INSERT CASE	RUBBER B INSERT CASE	1	
	11593	11593-LGC6-E00	RUBBER C INSERT CASE	RUBBER C INSERT CASE	1	
	12205	12205-LEA7-E00	BOLT SEALING 12MM	BOLT SEALING 12MM	6	
	15161	15161-LGC6-E00	PLUG SCREW SECTION FILTER	PLUG SCREW SECTION FILTER	1	
	15164	15164-LGC6-E00	PISTON COOLING JET	PISTON COOLING JET	1	
	1516A	1516A-LGC6-E00	SUCTION FILTER ASSY CRANK SIDE	SUCTION FILTER ASSY CRANK SIDE	1	
	15210	15210-PUA5-E00	PISTON PRESSURE VALVE D=12mm	PISTON PRESSURE VALVE D=12mm	1	
	15211	15211-LGC6-E00	COMPRESSION SPRING	COMPRESSION SPRING	1	
	15214	15214-PUA5-E00	PLUG SCREW COMPRESSION SPRING	PLUG SCREW COMPRESSION SPRING	1	
	15216	15216-LGC6-E00	COMPRESSION SPRING	COMPRESSION SPRING	1	
	1541A	1541A-LGC6-E00	OIL FILTER ASSY	OIL FILTER ASSY	1	
	15421	15421-PRA1-E00	OIL FILTER PIPE	OIL FILTER PIPE	1	
	15700	15700-LGC6-E00	OIL WATER HEAT EXCHANGER	OIL WATER HEAT EXCHANGER	1	
	32105	32105-LLJ3-E00	SUB HARNESS	SUB HARNESS	1	
	35500	35500-LGC6-E00	SW ASSY. OIL PRESSURE	SW ASSY. OIL PRESSURE	1	
	90033	90033-LGC6-E00	BOLT STUD 10X35	BOLT STUD 10X35	5	
	90412	90412-PUA5-E00	WASHER A6.1*11.5-A1	WASHER A6.1*11.5-A1	6	
	90442	90442-LGC6-E00	SEALING WASHER 18X8.5X2.3	SEALING WASHER 18X8.5X2.3	6	
	90465	90465-PUA5-E00	WASHER DIN7603-A14*20-CU	WASHER DIN7603-A14*20-CU	1	

Sales mark	Ref no	Part no	Description	Reg description	Regd no	E01
	90525	90525-KED9-900	LOCK PIN OIL 8*16	LOCK PIN OIL 8*16	2	
	90805	90805-LGC6-E00	CONE TYPE PLUG SPECIAL	CONE TYPE PLUG SPECIAL	1	
	91301	91301-LGC6-E00	O RING	O RING	1	
	91302	91302-PRA1-E00	O-RING 7X17	O-RING 7X17	1	
	91304	91304-LFA7-E00	O-RING 9.4*2.4	O-RING 9.4*2.4	3	
	91305	91305-LEH6-E00	O RING 19.8x1.9	O RING 19.8x1.9	1	
	91306	91306-PUA5-E00	O-RING 13*1.5	O-RING 13*1.5	2	
	91308	91308-LGC6-E00	O-RING 16*3.2	O-RING 16*3.2	1	
	91311	91311-PRA1-E00	O-RING 5.4X2.4 (FOR OIL PIPE)	O-RING 5.4X2.4 (FOR OIL PIPE)	2	
	91316	91316-PRA1-E00	O-RING 64X3	O-RING 64X3	1	
	91552	91552-LGC6-E00	COLLAR 13MM	COLLAR 13MM	6	
	94050	94050-10060	NUT FLANGE 10MM	NUT FLANGE 10MM	5	
	94301	94301-08140	DOWEL PIN 8*14	DOWEL PIN 8*14	1	
	95801	95801-08090-06	BOLT FLANGE 8*90	BOLT FLANGE 8*90	6	
	96001	96001-06035-06	BOLT FLANGE SH 6*35	BOLT FLANGE SH 6*35	8	
	96001A	96001-06055-06	BOLT FLANGE 6*55 **07 C.2005.07.01	BOLT FLANGE 6*55 **07 C.2005.07.01	4	
	96001B	96001-06090-06	BOLT FLANGE SH 6*90	BOLT FLANGE SH 6*90	8	
	96005	96005-PRA1-E00	BOLT M6*12	BOLT M6*12	2	
	96211	96211-16000	BALL STEEL #16	BALL STEEL #16	1	

Sales mark	Ref no	Part no	Description	Reg description	Regd no	E02
11384		11384-LEA7-E05	CLIP WATER PIPE	CLIP WATER PIPE	1	
11384A		11384-LGC6-E02	CLAMPER HOSE STOPPER	CLAMPER HOSE STOPPER	1	
12200		12200-LGC6-305	HEAD COMP CYLINDER	HEAD COMP CYLINDER	1	
12208		12208-LGC6-E00	SEAL.TUBE SPARK	SEAL.TUBE SPARK	2	
12209		12209-LEA3-900	SEAL VALVE STEM	SEAL VALVE STEM	8	
12251		12251-LGC6-E00	GASKET CYLINDER HEAD	GASKET CYLINDER HEAD	1	
1231A		1231A-LGC6-E00	COVER ASSY CYLN HEAD	COVER ASSY CYLN HEAD	1	
12391		12391-LGC6-E00	SEAL HEAD COVER	SEAL HEAD COVER	1	
14100		14100-LGC6-E00	CAMSHAFT COMP INLET	CAMSHAFT COMP INLET	0	
14200		14200-LGC6-E00	CAMSHAFT COMP EXHAUST	CAMSHAFT COMP EXHAUST	1	
14546		14546-LGC6-E00	CHAIN GUIDE UPPER ASM	CHAIN GUIDE UPPER ASM	1	
14711		14711-LGC6-E00	VALVE. INLET	VALVE. INLET	4	
14721		14721-LGC6-E00	VALVE. EXHAUST	VALVE. EXHAUST	4	
14731		14731-LGC6-E00	LIFTER VALVE	LIFTER VALVE	8	
14751		14751-LGC6-E00	SPRING VALVE	SPRING VALVE	8	
14771		14771-LGC6-C00	RETAINER ALVE SPRING	RETAINER ALVE SPRING	8	
14773		14773-LGC6-E00-01	SHIM 1.50	SHIM 1.50	1	
14773		14773-LGC6-E00-02	SHIM 1.55	SHIM 1.55	1	
14773		14773-LGC6-E00-03	SHIM 1.575	SHIM 1.575	1	
14773		14773-LGC6-E00-04	SHIM 1.60	SHIM 1.60	1	

Cylinder Head Cover Cylinder Head

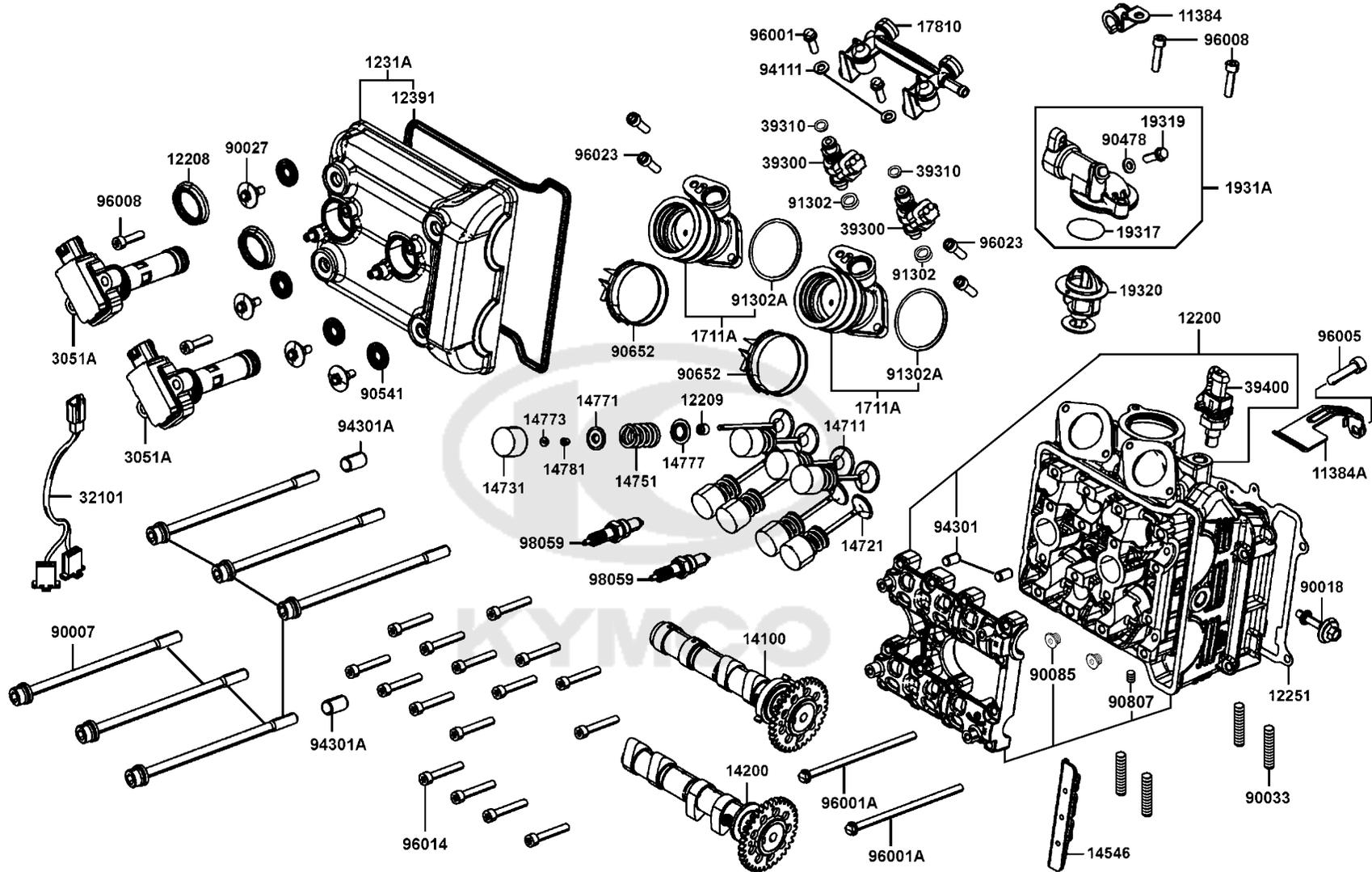

Sales mark	Ref no	Part no	Description	Reg description	Regd no	E02
	14773	14773-LGC6-E00-05	SHIM 1.625	SHIM 1.625	1	
	14773	14773-LGC6-E00-06	SHIM 1.65	SHIM 1.65	1	
	14773	14773-LGC6-E00-07	SHIM 1.675	SHIM 1.675	1	
	14773	14773-LGC6-E00-08	SHIM 1.70	SHIM 1.70	1	
	14773	14773-LGC6-E00-09	SHIM 1.725	SHIM 1.725	1	
	14773	14773-LGC6-E00-10	SHIM 1.75	SHIM 1.75	1	
	14773	14773-LGC6-E00-11	SHIM 1.775	SHIM 1.775	1	
	14773	14773-LGC6-E00-12	SHIM 1.80	SHIM 1.80	1	
	14773	14773-LGC6-E00-13	SHIM 1.825	SHIM 1.825	1	
	14773	14773-LGC6-E00-14	SHIM 1.85	SHIM 1.85	1	
	14773	14773-LGC6-E00-15	SHIM 1.875	SHIM 1.875	1	
	14773	14773-LGC6-E00-16	SHIM 1.90	SHIM 1.90	1	
	14773	14773-LGC6-E00-17	SHIM 1.925	SHIM 1.925	1	
	14773	14773-LGC6-E00-18	SHIM 1.95	SHIM 1.95	1	
	14773	14773-LGC6-E00-19	SHIM 2.0	SHIM 2.0	1	
	14777	14777-LGC6-E00	SEAT VALVE SPG	SEAT VALVE SPG	8	
	14781	14781-LGC6-C00	COTTER VALVE	COTTER VALVE	16	
	1711A	1711A-AKB8-E00	PIPE ASSY.. INLET	PIPE ASSY.. INLET	1	
	17810	17810-LGC6-E00	RAIL COMP FUEL SUPPLY	RAIL COMP FUEL SUPPLY	1	
	19317	19317-LBA2-E00	RING 48.3*2	RING 48.3*2	1	

E02

Cylinder Head Cover Cylinder Head

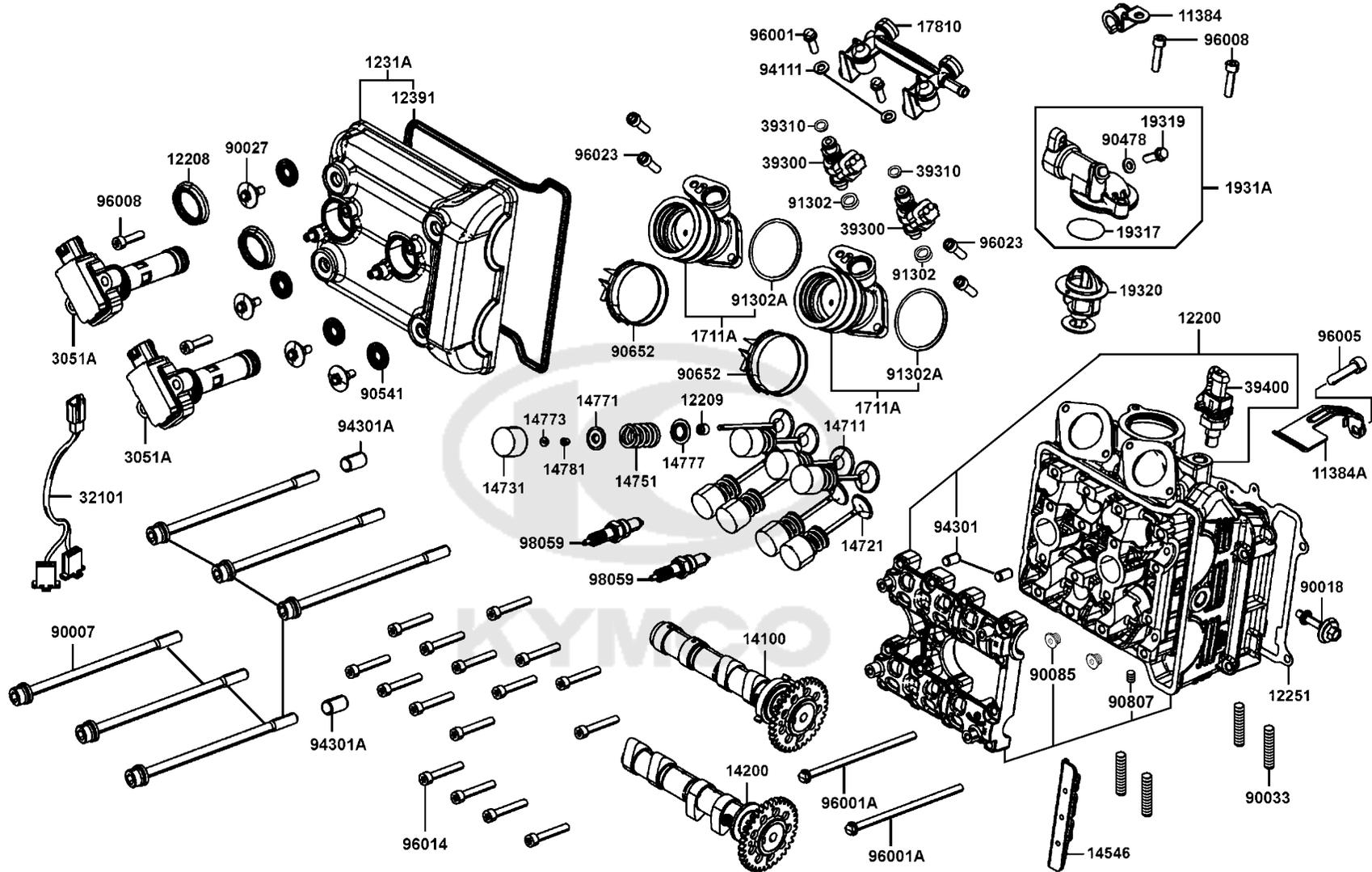

Sales mark	Ref no	Part no	Description	Reg description	Regd no	E02
	19319	19319-LGC6-E00	BREATHABLE SCREW_M6X12	BREATHABLE SCREW_M6X12	1	
	1931A	1931A-LGC6-E00	COVER ASSY THERMOSTAT	COVER ASSY THERMOSTAT	1	
	19320	19320-KED9-90A	THERMOSTAT	THERMOSTAT	1	
	3051A	3051A-LGC6-E00	COIL ASSY IGN	COIL ASSY IGN	1	
	32101	32101-LGC6-E00	SUB HARNESS COIL	SUB HARNESS COIL	1	
	39300	39300-KKE5-800	INJECTOR UNIT FUEL	INJECTOR UNIT FUEL	1	
	39310	39310-KKE5-305	RING INJECTOR SET	RING INJECTOR SET	2	
	39400	39400-LEA6-800	WATER TEMP SENSOR	WATER TEMP SENSOR	1	
	90007	90007-LGC6-E00	BOLT WASHER 9X160	BOLT WASHER 9X160	6	
	90018	90018-KKE5-E00	BOLT ASSY HEAD COVER	BOLT ASSY HEAD COVER	1	
	90027	90027-PUA5-E00	JACK SCREW M6 VALVE COVER 6*17	JACK SCREW M6 VALVE COVER 6*17	4	
	90033	90033-KGB4-C00	BOLT STUD M8X40 (C)	BOLT STUD M8X40 (C)	4	
	90085	90085-KKE5-E00	BOLT SEALING 18MM	BOLT SEALING 18MM	2	
	90478	90478-7L00-001	WASHER A 6MM	WASHER A 6MM	1	
	90541	90541-PUA5-E00	PROFILE SEALING WASHER	PROFILE SEALING WASHER	4	
#	90652	90652-GFY6-910	BAND 49 AIR/C CONNECTING TUBE	BAND 49 AIR/C CONNECTING TUBE	2	
	90807	90807-PRA1-E00	PLUG DIN 906 M8*1	PLUG DIN 906 M8*1	1	
	91302	91302-KKE5-800	SEAL RING	SEAL RING	1	
	91302A	91302-LDB2-E00	O-RING 37*3	O-RING 37*3	1	
	94111	94111-06800	WASHER SPRING 6MM	WASHER SPRING 6MM	2	

E02

Cylinder Head Cover Cylinder Head

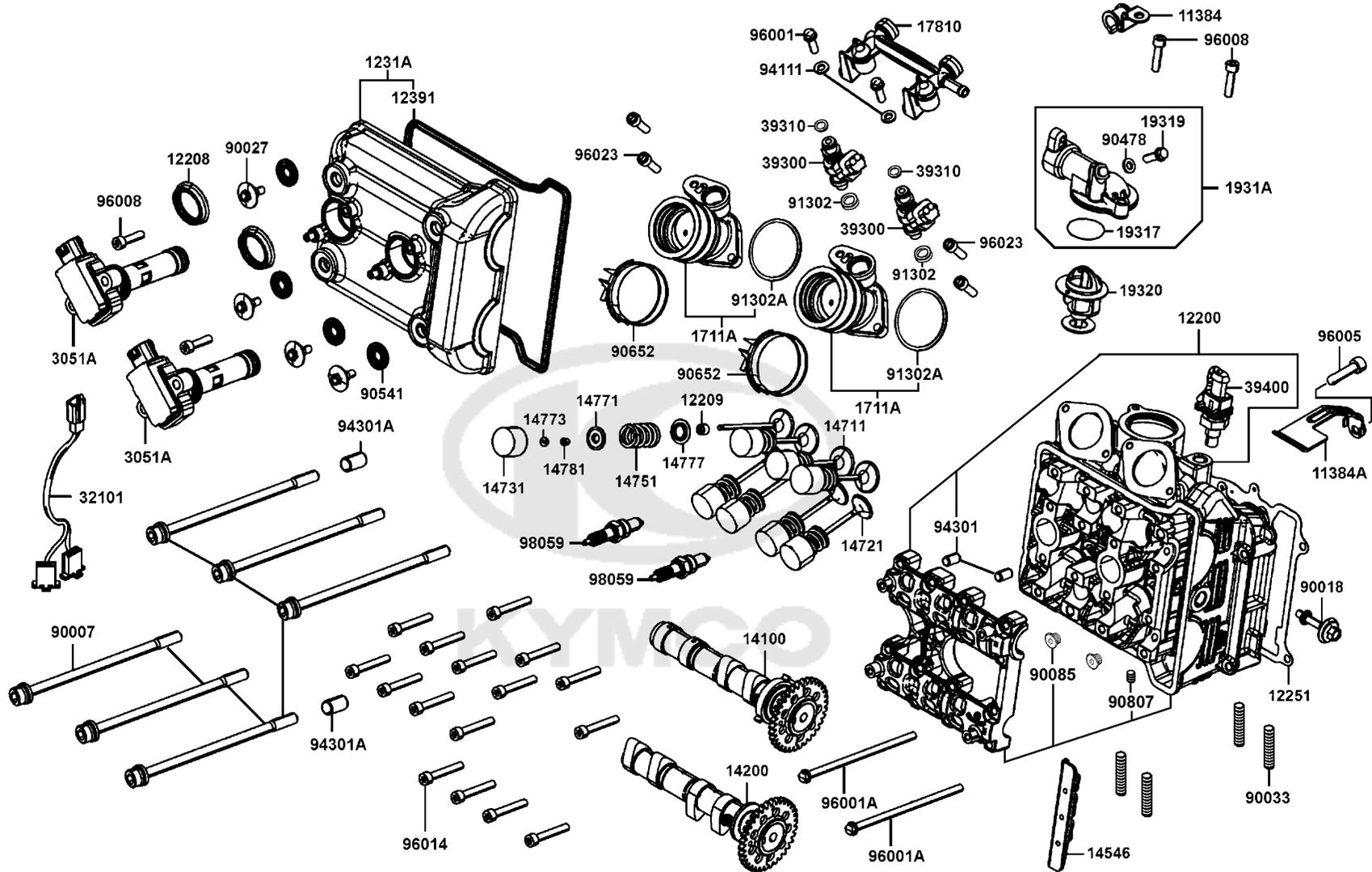

Sales mark	Ref no	Part no	Description	Reg description	Regd no	E02
94301		94301-08140	DOWEL PIN 8*14	DOWEL PIN 8*14	2	
94301A		94301-12200	DOWEL PIN 12*20	DOWEL PIN 12*20	2	
96001		96001-06018-06	BOLT FLANGE SH 6X18	BOLT FLANGE SH 6X18	2	
96001A		96001-06130-06	BOLT FLANGE SH 6*130	BOLT FLANGE SH 6*130	2	
96005		96005-PRA1-E00	BOLT M6*12	BOLT M6*12	1	
96008		96008-PRA1-E00	BOLT M6*25	BOLT M6*25	1	
96014		96014-PRA1-E00	BOLT M6*40	BOLT M6*40	16	
96023		96023-PRA1-E00	BOLT M6*20	BOLT M6*20	4	
98059		98059-57916-00	SPARK PLUG (CR7E)	SPARK PLUG (CR7E)	2	

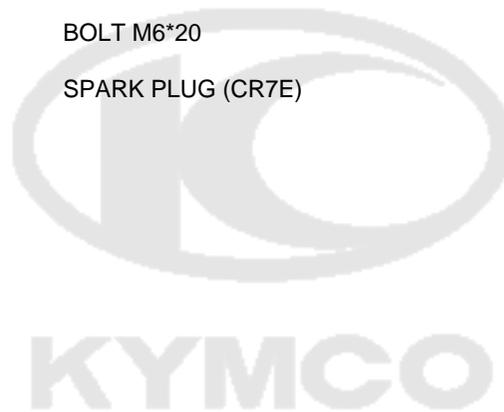

E03

Cylinder Piston

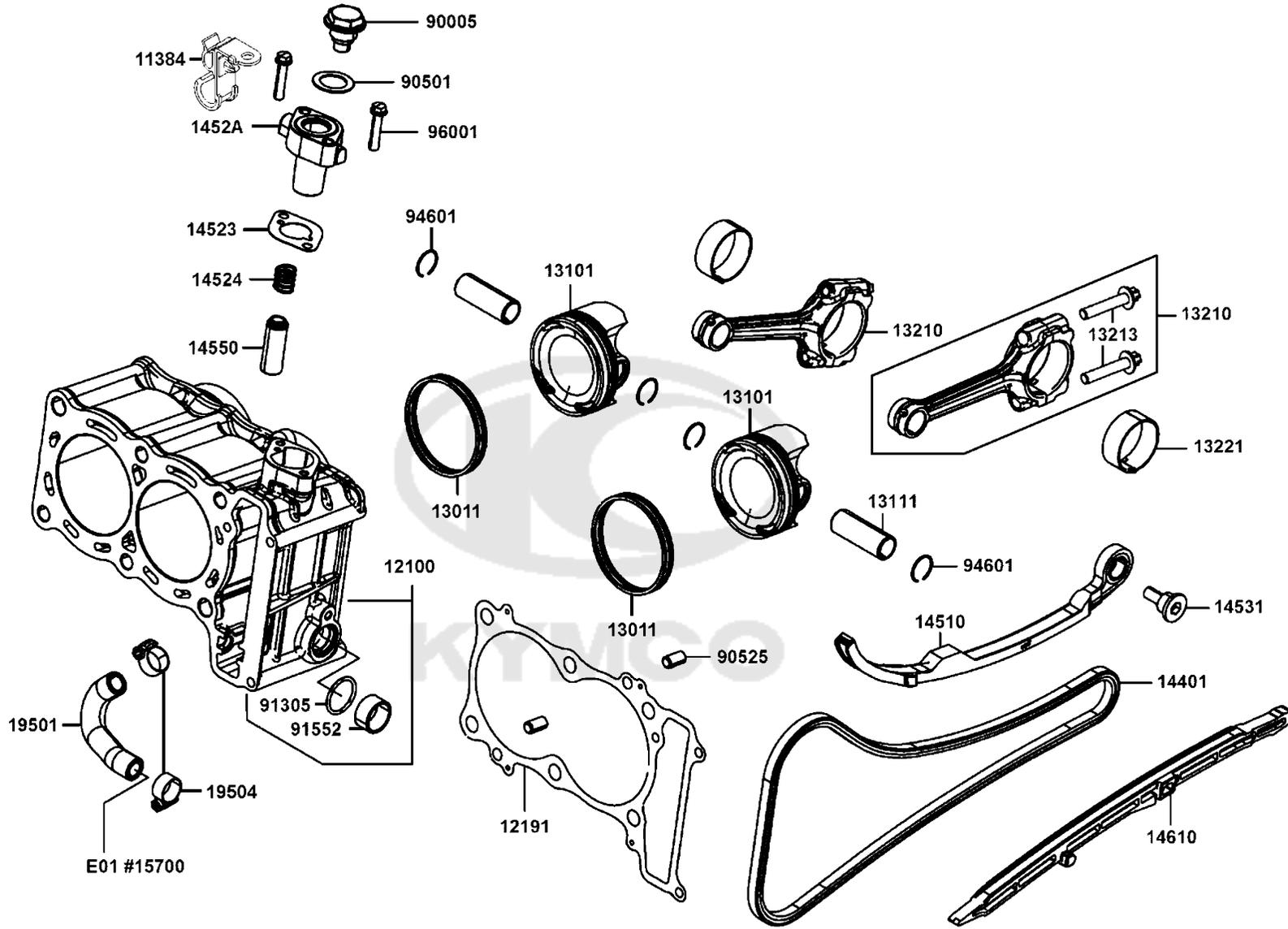

Sales mark	Ref no	Part no	Description	Reg description	Regd no	E03
	11384	11384-LGC6-E03	CLAMPER A RR BRK HOSE	CLAMPER A RR BRK HOSE	1	
	12100	12100-LGC6-E00	CYLINDER COMP (A)	CYLINDER COMP (A)	1	
	12191	12191-LGC6-E00	GASKET CYLINDER	GASKET CYLINDER	1	
	13011	13011-LGC6-E00	RING SET PISTON	RING SET PISTON	2	
	13101	13101-LGC6-E02	PISTON	PISTON	2	
	13111	13111-LGC6-E00	PIN PISTON	PIN PISTON	2	
	13210	13210-LGC6-E00-1	CONN ROD ASSY 39(0~+0.008)	CONN ROD ASSY 39(0~+0.008)	2	
	13210	13210-LGC6-E00-2	CONN ROD ASSY 39(+0.008~+0.016)	CONN ROD ASSY 39(+0.008~+0.016)	2	
	13213	13213-LGC6-E00	BOLT CONN ROD	BOLT CONN ROD	4	
	13221	13221-LGC6-E00-A	BEARING CONN. ROD/ YELLOW	BEARING CONN. ROD/ YELLOW	4	
	13221	13221-LGC6-E00-B	BEARING CONN. ROD/ BLUE	BEARING CONN. ROD/ BLUE	4	
	13221	13221-LGC6-E00-C	BEARING CONN. ROD/ RED	BEARING CONN. ROD/ RED	4	
	13221	13221-LGC6-E00-D	BEARING CONN. ROD/ GREEN	BEARING CONN. ROD/ GREEN	4	
	13221	13221-LGC6-E00-E	BEARING CONN. ROD/ BLACK	BEARING CONN. ROD/ BLACK	4	
	14401	14401-LGC6-E00	CHAIN. CAM	CHAIN. CAM	1	
	14510	14510-LGC6-E00	TENSIONER. CAM CHAIN	TENSIONER. CAM CHAIN	1	
	14523	14523-KKE5-E01	GASKET TENSIONER LIFTER	GASKET TENSIONER LIFTER	1	
	14524	14524-KKE5-E01	SPRING OIL TENSIONER	SPRING OIL TENSIONER	1	
	1452A	1452A-ZPA3-E00	CASE ASM LIFTER TENSIONER	CASE ASM LIFTER TENSIONER	1	
	14531	14531-KHE7-900	PIVOT CAM CHAIN TENSIONER	PIVOT CAM CHAIN TENSIONER	1	

E03

Cylinder Piston

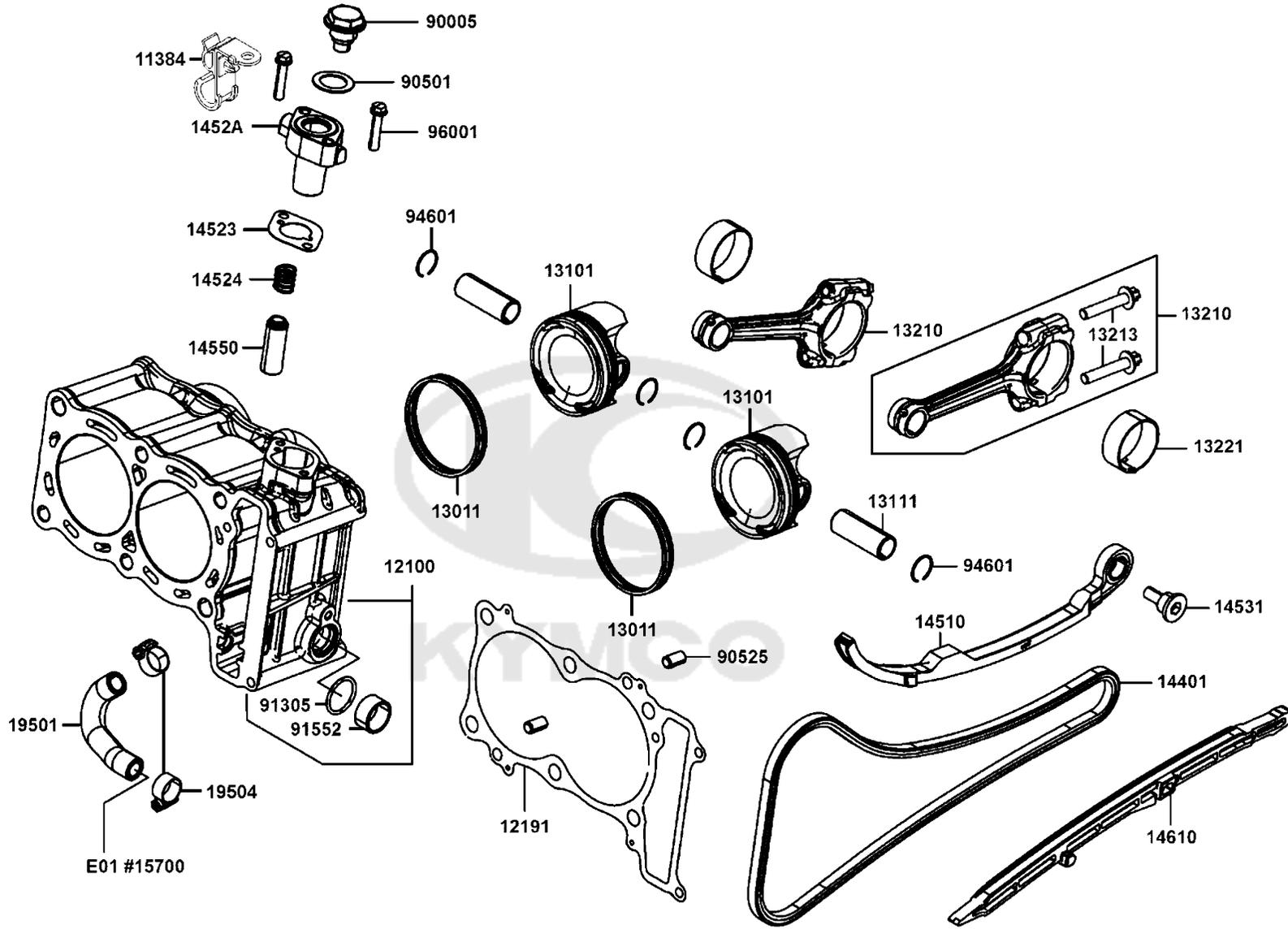

Sales mark	Ref no	Part no	Description	Reg description	Regd no	E03
14550		14550-KKE5-E02	CHAIN TENSIONER	CHAIN TENSIONER	1	
14610		14610-LGC6-E00	GUIDE COMP.. CAM CHAIN	GUIDE COMP.. CAM CHAIN	1	
19501		19501-LGC6-E00	HOSE. WATER A	HOSE. WATER A	1	
19504		19504-LBA2-E00	CLAMP D16.8	CLAMP D16.8	2	
90005		90005-LEH6-E00	BOLT SPECIAL M18*1.0	BOLT SPECIAL M18*1.0	1	
90501		90501-LEH6-E00	WASHER 28*18.2*1	WASHER 28*18.2*1	1	
90525		90525-KED9-900	LOCK PIN OIL 8*16	LOCK PIN OIL 8*16	2	
91305		91305-LEH6-E00	O RING 19.8x1.9	O RING 19.8x1.9	1	
91552		91552-LEH6-E00	COLLAR 20mm	COLLAR 20mm	1	
94601		94601-17000	CLIP PISTON PIN 17MM	CLIP PISTON PIN 17MM	4	
96001		96001-06028-06	BOLT FLANGE SH 6*28	BOLT FLANGE SH 6*28	1	



E04

Left Side Cover Water Pump

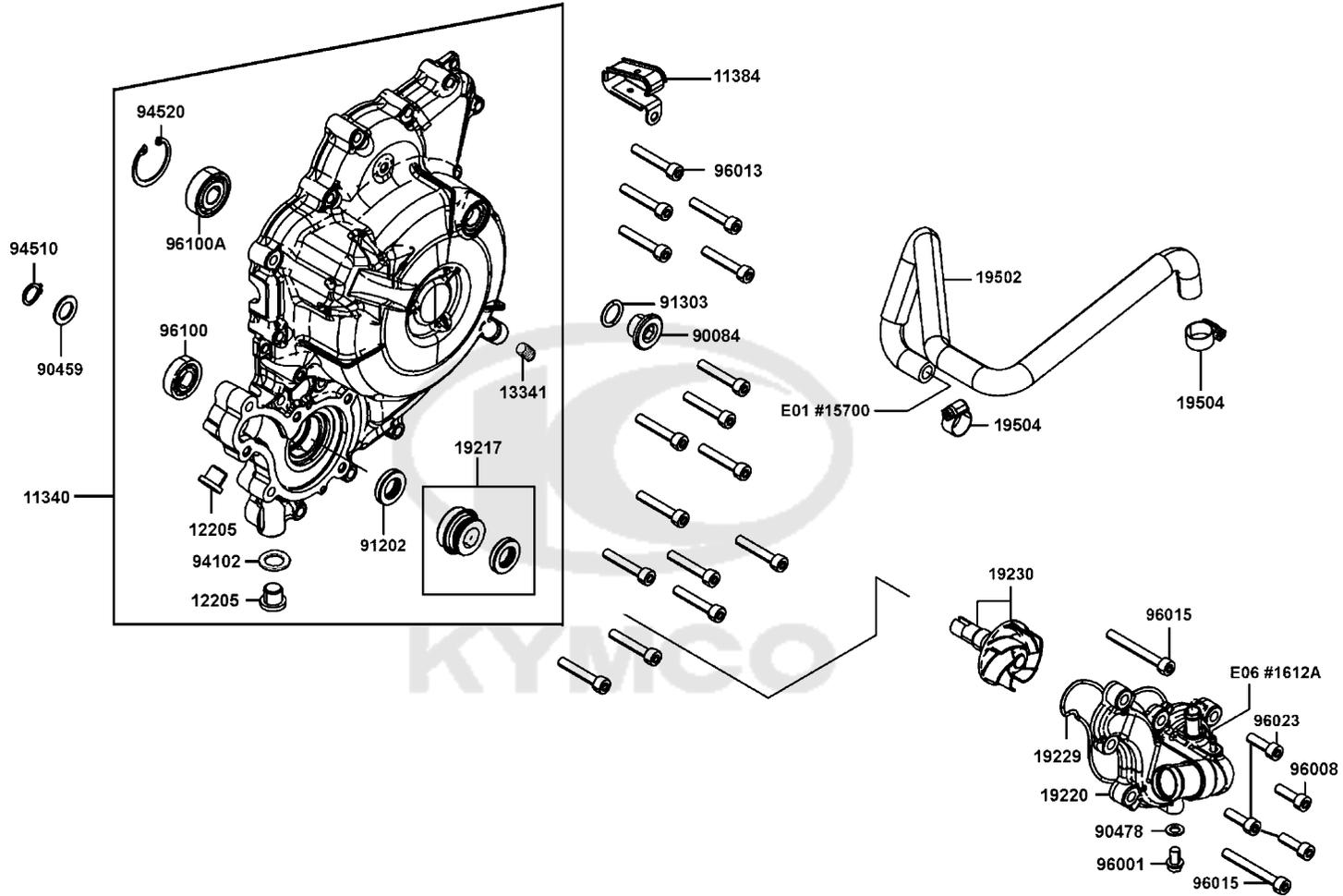

Sales mark	Ref no	Part no	Description	Reg description	Regd no	E04
	11340	11340-LGC6-305	COVER SET L SIDE	COVER SET L SIDE	1	
	11340	1134A-AKB8-305	COVER SET L SIDE	COVER SET L SIDE	1	
	11384	11384-LGC6-E00	CLAMPER RR BRK HOSE	CLAMPER RR BRK HOSE	1	
#	12205	12205-KHE8-310	BOLT SEALING 12MM (CG)	BOLT SEALING 12MM (CG)	2	
	13341	13341-LGC6-E00	GRUB SCREW M6X6	GRUB SCREW M6 X 7	1	
		19215-AKB8-EA5	IMPELLER WATER PUMP	IMPELLER WATER PUMP	1	
	19217	19217-AEE2-900	MECHANICAL SEAL	MECHANICAL SEAL	1	
	19217	19217-PRB9-E01	SEAL MECHANICAL	SEAL MECHANICAL	1	
	19220	19220-LGC6-E00	COVER COMP WATER PUMP	COVER COMP WATER PUMP	1	
	19229	19229-LGC6-E00	O-RING W/P BODY	O-RING W/P BODY	1	
	19230	19230-LGC6-E00	SHAFT ASSY IMPELLER	SHAFT ASSY IMPELLER	1	
		19231-AKB8-EA5	SHAFT WATER PUMP	SHAFT WATER PUMP	1	
	19502	19502-LGC6-E00	HOSE B WATER	HOSE B WATER	1	
	19504	19504-LBA2-E00	CLAMP D16.8	CLAMP D16.8	4	
**	90084	90084-4H28-001	CAP ACG	CAP ACG	1	
	90459	90459-LKF5-E00	WASHER 12MM	WASHER 12MM	1	
	90478	90478-7L00-001	WASHER A 6MM	WASHER A 6MM	1	
	91202	91202-LKG2-900	OIL SEAL 13.7*24*5	OIL SEAL 13.7*24*5	1	
	91303	91303-3G77-001	O-RING 13.8*2.5	O-RING 13.8*2.5	1	
	94102	94102-LGC6-E00	WASHER 18X12.2X1 AL	WASHER 18X12.2X1 AL	1	

E04

Left Side Cover Water Pump

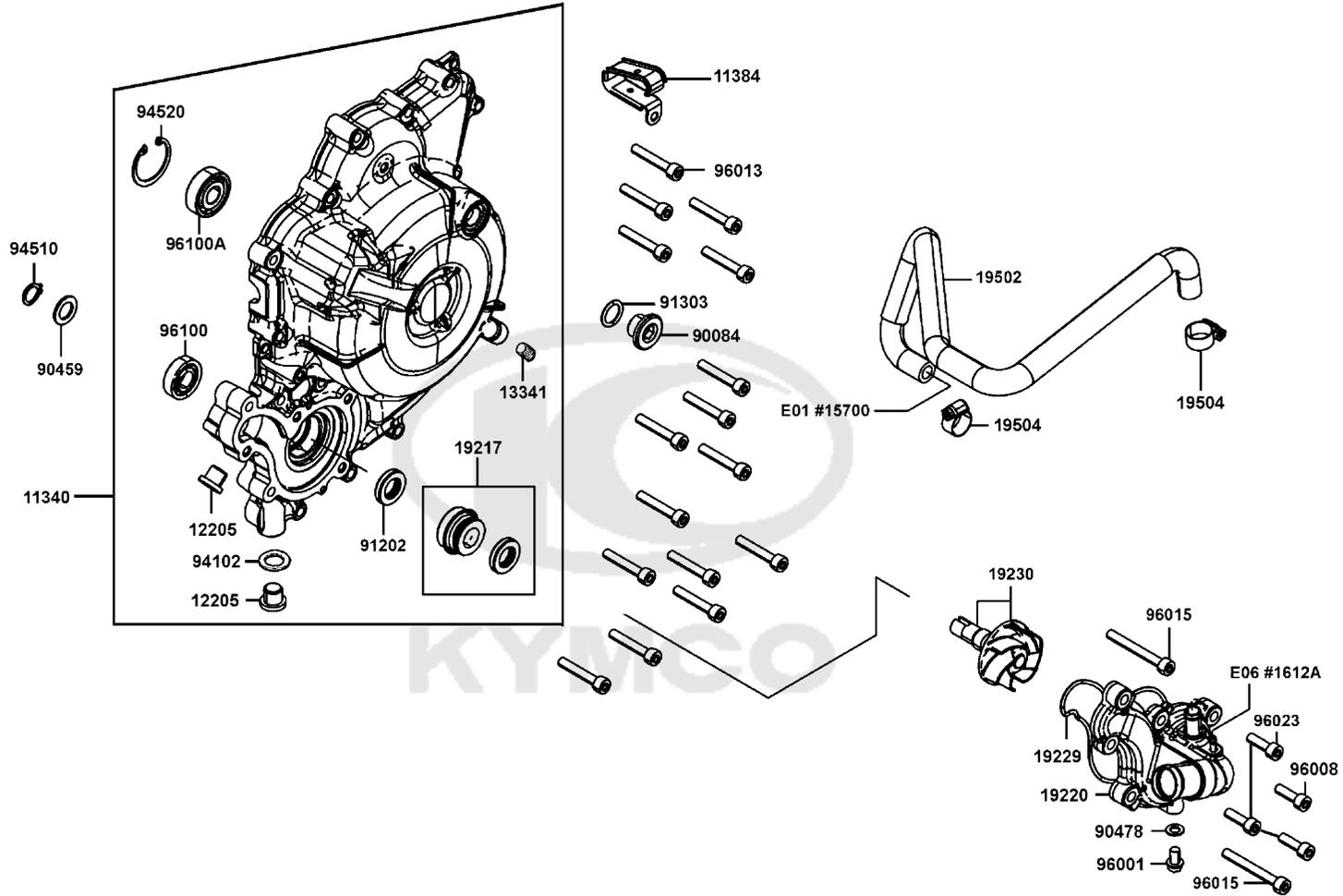

Sales mark	Ref no	Part no	Description	Reg description	Regd no	E04
94510		94510-12000	CIR CLIP EXTERNAL 12	CIR CLIP EXTERNAL 12	1	
94520		94520-32180	CIR CLIP IN 32	CIR CLIP IN 32	1	
96001		96001-06010-06	BOLT FLANGE 6*10	BOLT FLANGE 6*10	1	
96008		96008-PRA1-E00	BOLT M6*25	BOLT M6*25	1	
96013		96013-LGC6-E00	M6X35-8.8-ZNNIV SI	M6X35-8.8-ZNNIV SI	16	
96015		96015-PRA1-E00	BOLT M6*50	BOLT M6*50	2	
96023		96023-PRB9-E00	BOLT M6*20	BOLT M6*20	4	
96100		96100-60010-00	BEARING RADIAL BALL 6001	BEARING RADIAL BALL 6001	1	
96100A		96100-62010-00	BRG BALL RADIAL 6201	BRG BALL RADIAL 6201	1	



Right Crankcase Cover Shaft Main Shaft Counter

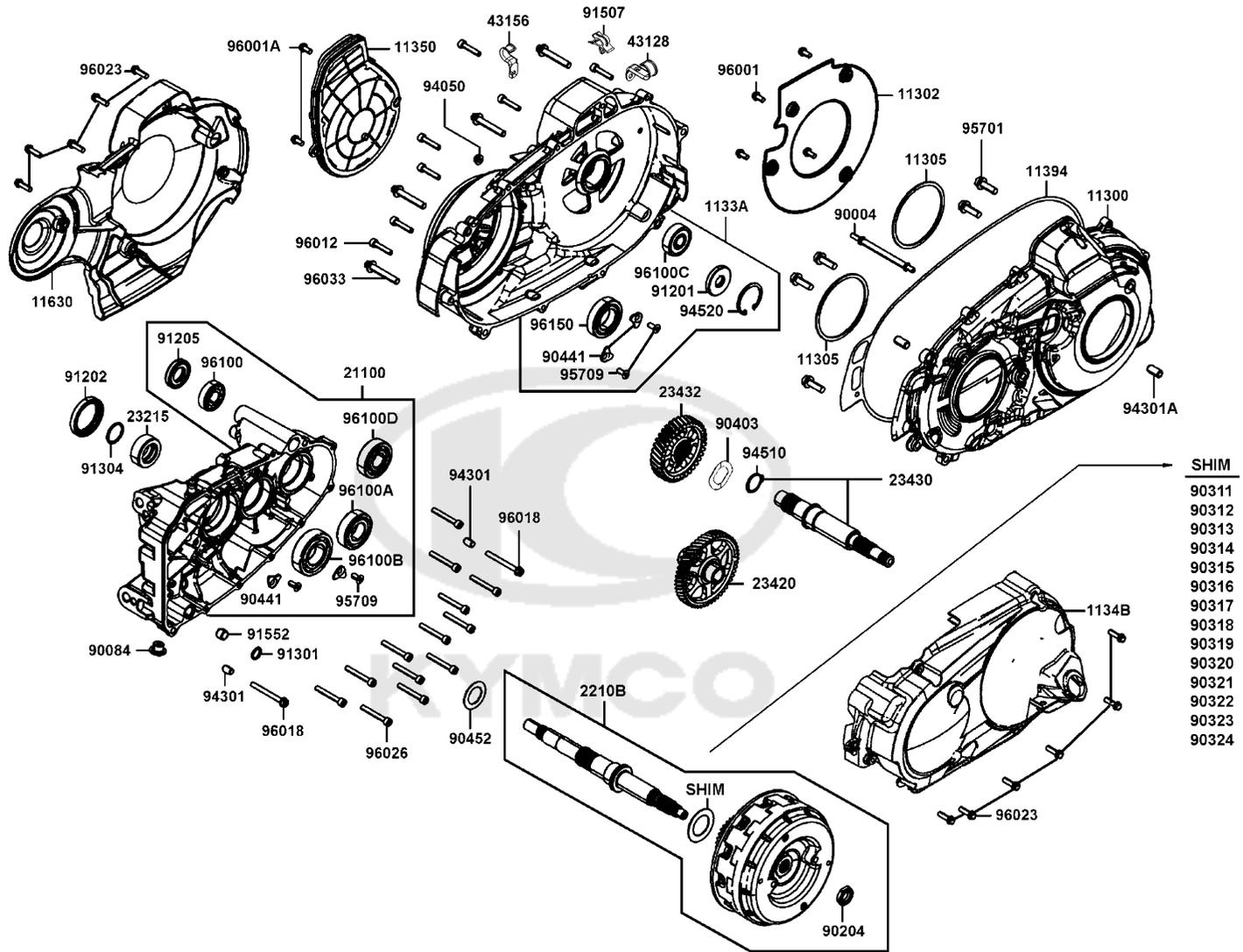

- SHIM
- 90311
- 90312
- 90313
- 90314
- 90315
- 90316
- 90317
- 90318
- 90319
- 90320
- 90321
- 90322
- 90323
- 90324

Sales mark	Ref no	Part no	Description	Reg description	Regd no	E05
	11300	11300-LGC6-E00	CASE CVT	CASE CVT	1	
	11302	11302-LGC6-E00	PLATE AIR INTAKE	PLATE AIR INTAKE	1	
	11305	11305-LGC6-E00	GASKET CVT CASE	GASKET CVT CASE	1	
	1133A	1133A-LGC6-E00	COVER COMP CVT	COVER COMP CVT	1	
**	1134B	1134B-LGC6-E00	COVER COMP L COVER	COVER COMP L COVER	1	
	11350	11350-LGC6-E00	ELEMENT COMP CVT COVER	ELEMENT COMP CVT COVER	1	
	11394	11394-LGC6-E00	GASKET. R. COVER	GASKET.CVT COVER	1	
**	11630	11630-LGC6-E00	COVER COMP R COVER (Black)	COVER COMP R COVER (Black)	1	
	21100	21100-LGC6-E00	CASE COMP R MISSION	CASE COMP.R MISSION	1	
	2210B	2210B-LGC6-E02	WET CLUTCH ASSY	WET CLUTCH ASSY	1	
	23215	23215-LGC6-E00	SPACER FIXED DRIVE	SPACER FIXED DRIVE	1	
	23420	23420-LGC6-E00	SHAFT COMP COUNTER	SHAFT COMP COUNTER	1	
	23430	23430-LGC6-E00	SHAFT COMP FINAL	SHAFT COMP FINAL	1	
	23432	23432-LGC6-E00	GEAR FINAL	GEAR FINAL	1	
	43128	43128-AKB8-E00	CLAMPER HOSE&CABLE	CLAMPER HOSE&CABLE	1	
	43156	43156-AKB8-E00	CLAMPER HOSE	CLAMPER HOSE	1	
	90004	90004-LGC6-E00	BOLT SPECIAL	BOLT SPECIAL	1	
	90084	90084-KKE5-E00	CAPE OIL CHANNEL	CAPE OIL CHANNEL	1	
	90204	90204-LGC6-E00	NUT FLANGE M16X1.0	NUT FLANGE M16X1.0	1	
	90311	90311-PWB1-900	SHIM DRIVEN BEVEL GEAR A	SHIM DRIVEN BEVEL GEAR A (0.575~0.625)	1	

Right Crankcase Cover Shaft Main Shaft Counter

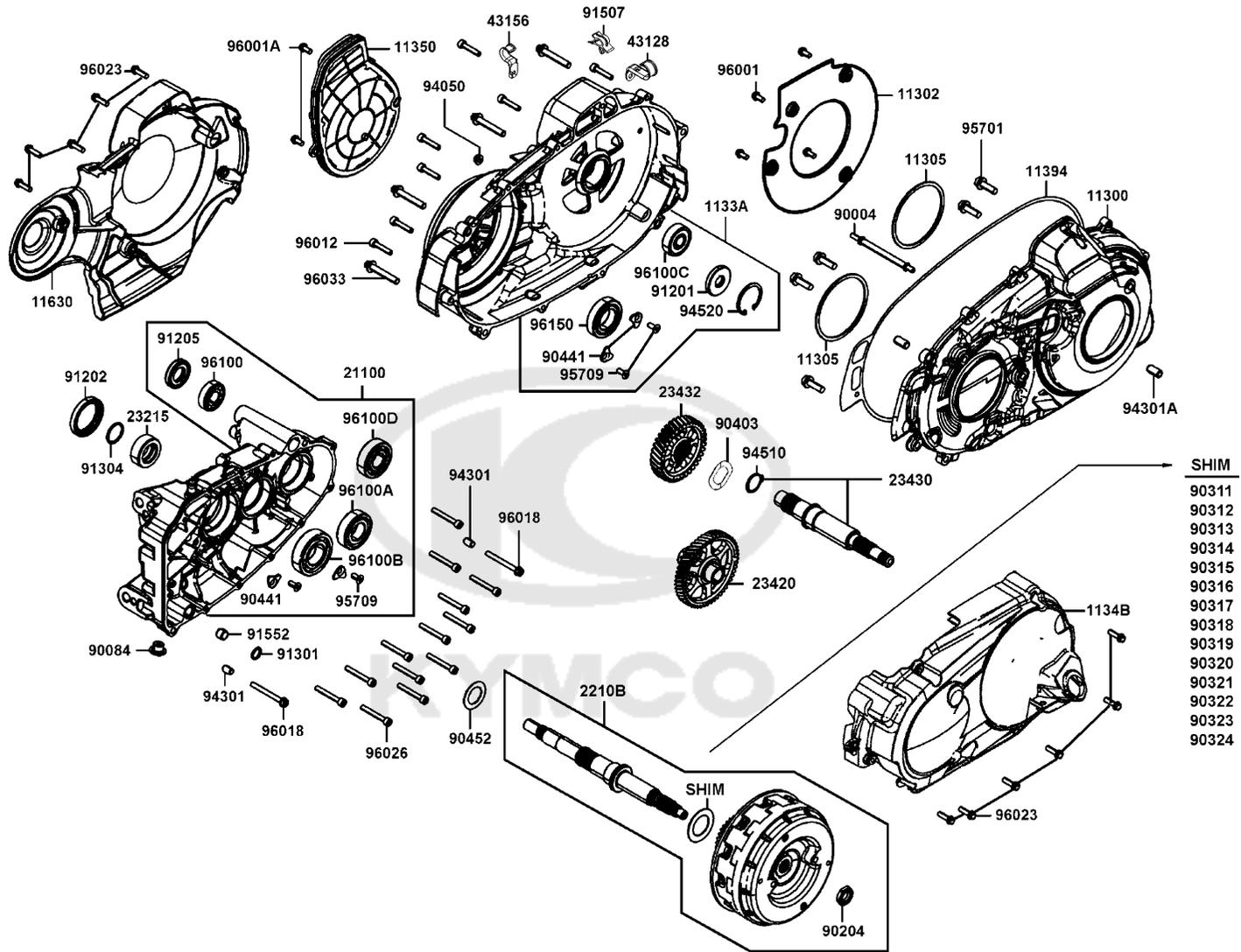

Sales mark	Ref no	Part no	Description	Reg description	Regd no	E05
	90312	90312-PWB1-900	SHIM DRIVEN BEVEL GEAR B	SHIM DRIVEN BEVEL GEAR B (0.625~0.675)	1	
	90313	90313-PWB1-900	SHIM DRIVEN BEVEL GEAR C	SHIM DRIVEN BEVEL GEAR C (0.675~0.725)	1	
	90314	90314-PWB1-900	SHIM DRIVEN BEVEL GEAR D	SHIM DRIVEN BEVEL GEAR D (0.725~0.775)	1	
	90315	90315-PWB1-900	SHIM DRIVEN BEVEL GEAR E	SHIM DRIVEN BEVEL GEAR E (0.775~0.825)	1	
	90316	90316-PWB1-900	SHIM DRIVEN BEVEL GEAR F	SHIM DRIVEN BEVEL GEAR F (0.825~0.875)	1	
	90317	90317-PWB1-900	SHIM DRIVEN BEVEL GEAR G	SHIM DRIVEN BEVEL GEAR G (0.875~0.925)	1	
	90318	90318-PWB1-900	SHIM DRIVEN BEVEL GEAR H	SHIM DRIVEN BEVEL GEAR H (0.925~0.975)	1	
	90319	90319-PWB1-900	SHIM DRIVEN BEVEL GEAR I	SHIM DRIVEN BEVEL GEAR I (0.975~1.025)	1	
	90320	90320-PWB1-900	SHIM DRIVEN BEVEL GEAR J	SHIM DRIVEN BEVEL GEAR J (1.025~1.075)	1	
	90321	90321-PWB1-900	SHIM DRIVEN BEVEL GEAR K	SHIM DRIVEN BEVEL GEAR K (1.075~1.125)	1	
	90322	90322-PWB1-900	SHIM DRIVE BEVEL GEAR T=1.15MM	SHIM DRIVE BEVEL GEAR T=1.15MM	1	
	90323	90323-PWB1-900	SHIM DRIVEN BEVEL GEAR M	SHIM DRIVEN BEVEL GEAR M (1.175~1.225)	1	
	90324	90324-PWB1-900	SHIM DRIVEN BEVEL GEAR N	SHIM DRIVEN BEVEL GEAR N (1.225~1.275)	1	
	90403	90403-LGC6-E00	WAVE WASHER 25MM	WAVE WASHER 25MM	1	
	90441	90441-LKF5-E00	PLATE BRG HOLD	PLATE BRG HOLD	4	
	90452	90452-LBA7-900	WASHER THRUST 25MM	WASHER THRUST 25MM	1	
	91201	91201-LGC6-E00	OIL SEAL 15X42X7	OIL SEAL 15X42X7	1	
	91202	91202-LGC6-E00	OIL SEAL 42X55X8	OIL SEAL 42X55X8	1	
	91205	91205-LGC6-E00	OIL SEAL 22X40X7	OIL SEAL 22X40X7	1	
	91301	91301-LGC6-E00	O RING	O RING	1	

Right Crankcase Cover Shaft Main Shaft Counter

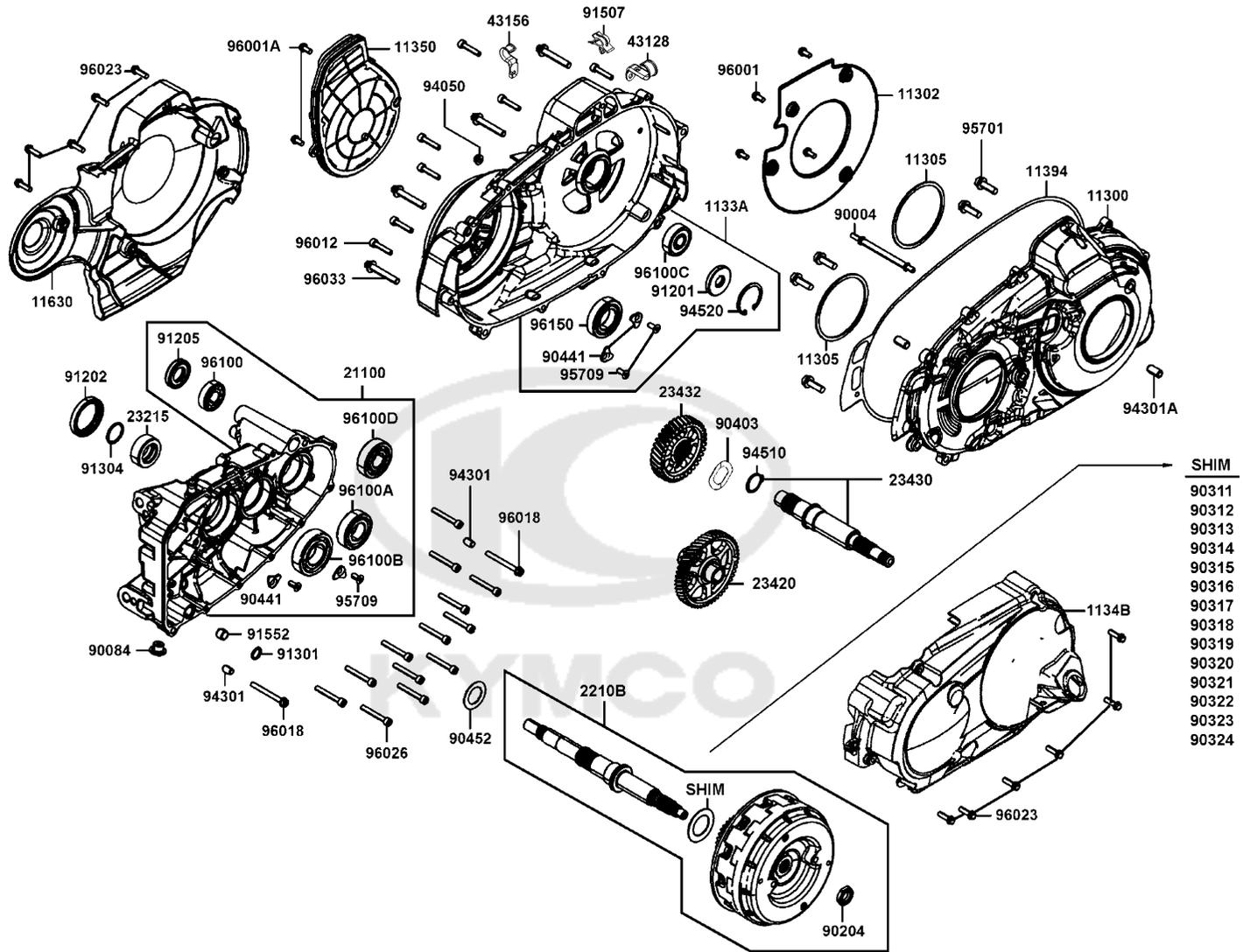

- SHIM
- 90311
- 90312
- 90313
- 90314
- 90315
- 90316
- 90317
- 90318
- 90319
- 90320
- 90321
- 90322
- 90323
- 90324

Sales mark	Ref no	Part no	Description	Reg description	Regd no	E05
	91304	91304-LGC6-E00	O RING 25.5X2.5	O RING 25.5X2.5	1	
	91507	91507-LEA7-E00	CLIP	CLIP	1	
	91552	91552-LGC6-E00	COLLAR 13MM	COLLAR 13MM	1	
	94050	94050-06060	NUT FLANGE 6MM	NUT FLANGE 6MM	1	
	94301	94301-08140	DOWEL PIN 8*14	DOWEL PIN 8*14	2	
	94301A	94301-10200	DOWEL PIN 10*20	DOWEL PIN 10*20	2	
	94510	94510-25000	CIR CLIP EXTERNAL 25	CIR CLIP EXTERNAL 25	1	
	94520	94520-42000	CIR CLIP IN 42MM	CIR CLIP IN 42MM	1	
	95701	95701-08025-06	BOLT FLANGE 8*25	BOLT FLANGE 8*25	5	
	95709	95709-PRA1-E00	SCREW COUNTERSUNK M6*12	SCREW COUNTERSUNK M6*12	4	
	96001	96001-06012-06	BOLT FLANGE SH 6*12	BOLT FLANGE SH 6*12	4	
	96001A	96001-06014-06	BOLT FLANGE SH 6X14	BOLT FLANGE SH 6X14	2	
	96012	96012-PRA1-E00	BOLT M6*30	BOLT M6*30	7	
	96018	96018-PRA1-E00	BOLT M6*60	BOLT M6*60	2	
	96023	96023-PRA1-E00	BOLT M6*20	BOLT M6*20	11	
	96026	96026-PRA1-E00	BOLT M6*45	BOLT M6*45	13	
	96033	96033-PRA1-E00	BOLT M8*50	BOLT M8*50	3	
	96100	96100-30203-10	BEARING BALL RADIAL	BEARING BALL RADIAL	1	
	96100A	96100-62050-00	BEARING BALL RADIAL 6205	BEARING BALL RADIAL 6205	1	
	96100B	96100-62060-00	BRG RADIAL BALL 6206	BRG RADIAL BALL 6206	1	

Right Crankcase Cover Shaft Main Shaft Counter

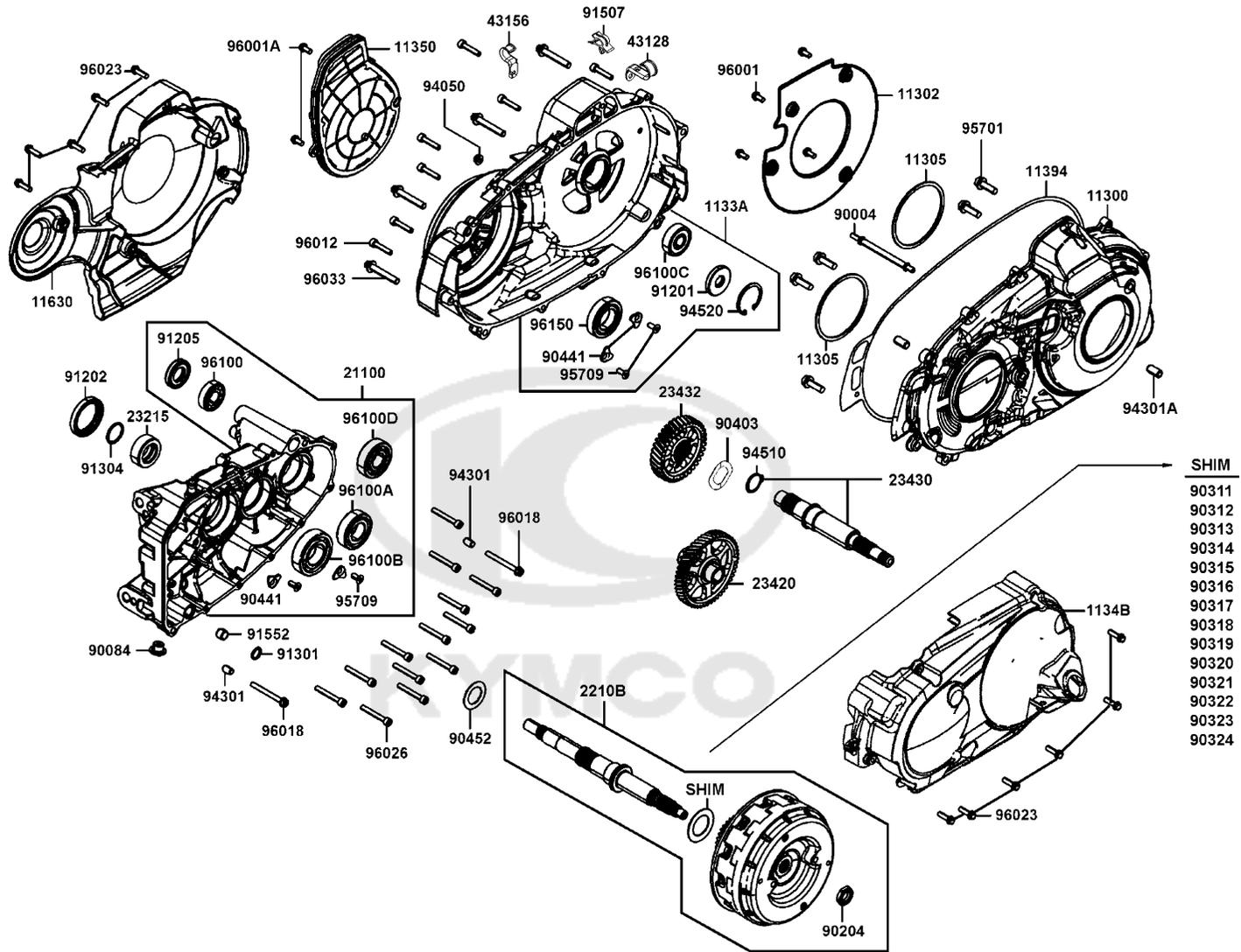

Sales mark	Ref no	Part no	Description	Reg description	Regd no	E05
------------	--------	---------	-------------	-----------------	---------	------------

96100C		96100-63020-00	BRG BALL RADIAL 6302	BRG BALL RADIAL 6302	1	
96100D		96100-63040-00	BRG BALL RADIAL 6304	BRG BALL RADIAL 6304	1	
96150		96150-60060-10	BEARING BALL RADIAL 6006	BEARING BALL RADIAL 6006	1	



E06

Throttle Body

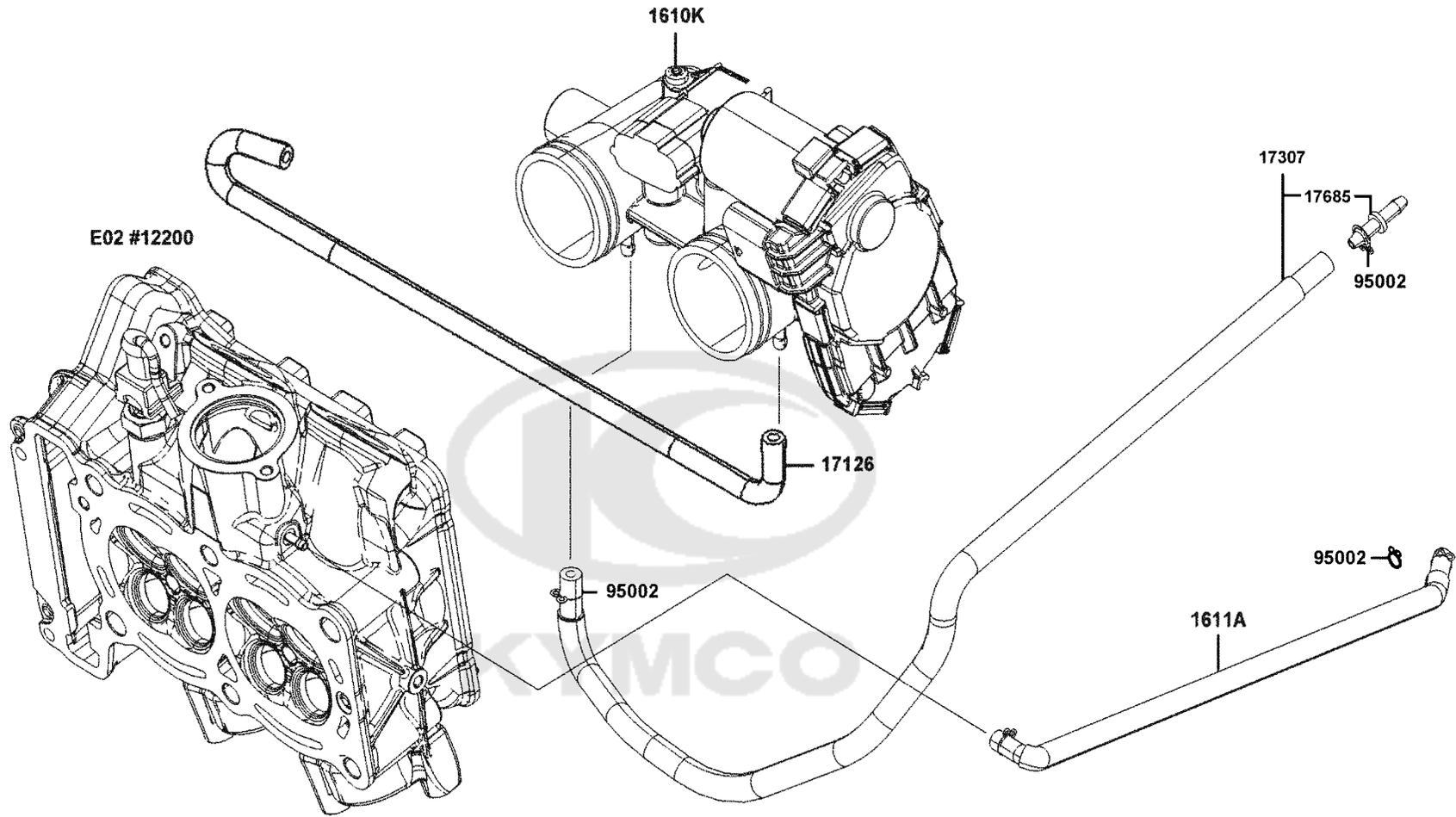

Sales mark	Ref no	Part no	Description	Reg description	Regd no	E06
1610K		1610K-AKB8-E00	THROTTLE BODY ASSY	THROTTLE BODY ASSY	1	
1611A		1611A-LGC6-E00	HOSE A ASSY T/H BODY	HOSE A ASSY T/H BODY	1	
17126		17126-AKB8-E00	TUBE ASSY	TUBE ASSY	1	
17307		17307-LGC6-E00	TUBE ASSY	TUBE ASSY	1	
17685		17685-GLE0-301	JOINT COCK-CARB TUBE	JOINT COCK-CARB TUBE	1	
95002		95002-02070	CLIP B7 TUBE	CLIP B7 TUBE	5	



E07

Transmission Pulley

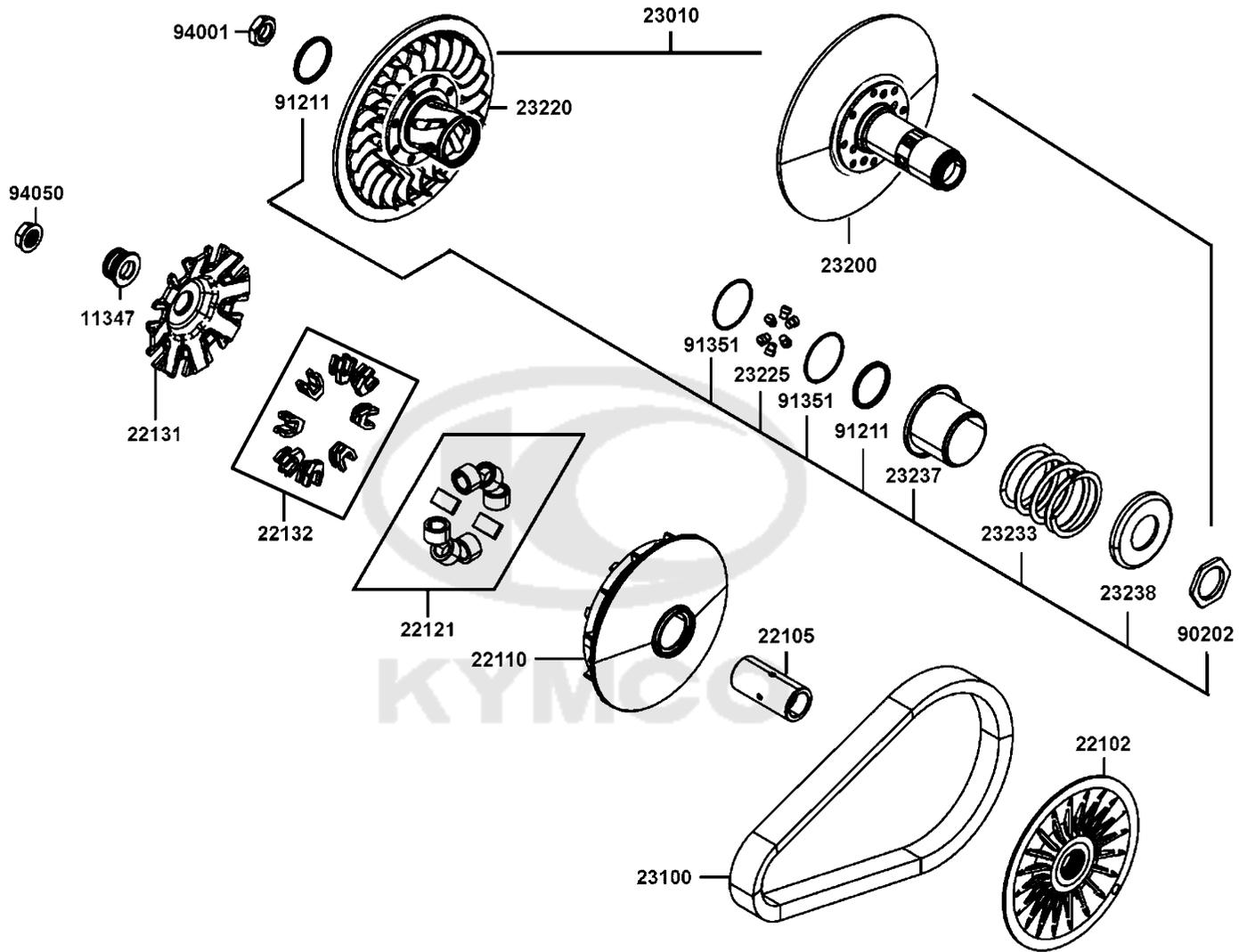

Sales mark	Ref no	Part no	Description	Reg description	Regd no	E07
11347		11347-LKF5-E00	BOSS DRIVE SHAFT	BOSS DRIVE SHAFT	1	
22102		22102-LGC6-E00	FACE DRIVE	FACE DRIVE	1	
22105		22105-LGC6-E00	BOSS DRIVE FACE	BOSS DRIVE FACE	1	
22110		22110-LGC6-E00	FACE COMP MOVABLE	FACE COMP MOVABLE	1	
22121		22121-LGC6-305	ROLLER SET WEIGHT (1SET:8 PCS)	ROLLER SET WEIGHT (1SET:8 PCS)	1	
22131		22131-LGC6-E00	PLATE RAMP	PLATE RAMP	1	
22132		22132-ADG5-305	PIECE SET SLIDE(1 SET:8 PCS)	PIECE SET SLIDE(1 SET:8 PCS)	1	
23010		23010-LGC6-E00	PULLEY ASSY DRIVEN	PULLEY ASSY DRIVEN	1	
23100		23100-LGC6-E00	BELT DRIVE (N-6N)	BELT DRIVE (N-6N)	1	
23200		23200-LGC6-E00	FACE COMP DRIVEN A	FACE COMP DRIVEN A	1	
23220		23220-LGC6-E00	FACE COMP MOVABLE DRIVEN	FACE COMP. MOVABLE DRIVEN	1	
23225		23225-LKF5-E00	PIN ROLLER GUIDE	PIN ROLLER GUIDE	6	
23233		23233-LGC6-E00	SPG DRIVEN FACE	SPG DRIVEN FACE	1	
23237		23237-LGC6-E00	COLLAR SEAL	COLLAR SEAL	1	
23238		23238-LDB5-E00	COLLAR SPG	COLLAR SPG	1	
90202		90202-LDB5-E00	NUT SPECIAL 36MM	NUT SPECIAL 36MM	1	
91211		91211-LGC6-E00	SEAL DRIVEN 41X47X4	SEAL DRIVEN 41X47X4	2	
91351		91351-LDB5-E00	O-RING PINION CAP	O-RING PINION CAP	2	
94001		94001-LGC6-E00	NUT FLANGE M18X1.0	NUT FLANGE M18X1.0	1	
94050		94050-LKF5-E00	NUT FLANGE 18MM	NUT FLANGE 18MM	1	

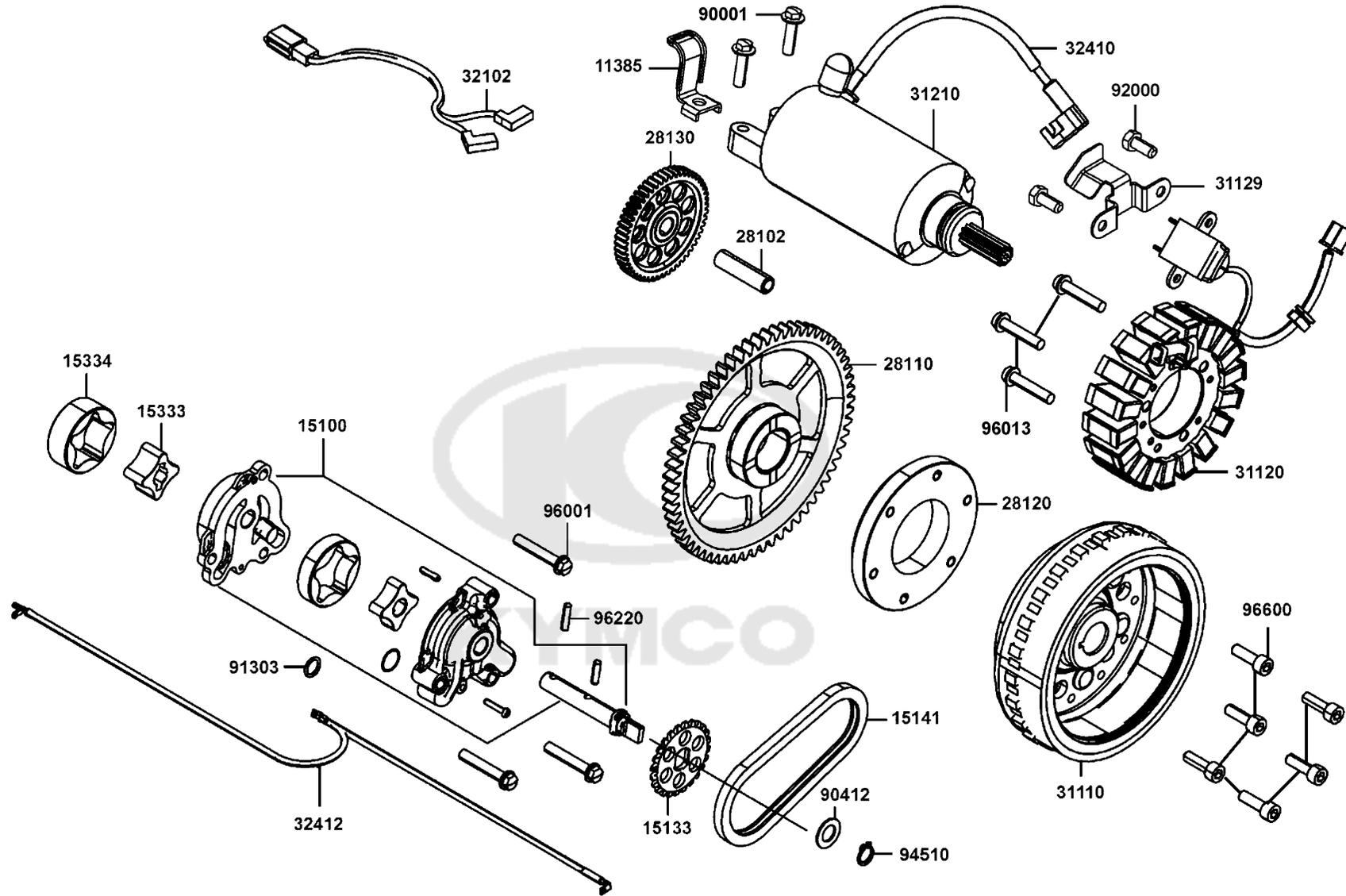

Sales mark	Ref no	Part no	Description	Reg description	Regd no	E08
	11385	11385-LGC6-E00	CLAMP BLOW BY HOSE	CLAMP BLOW BY HOSE	1	
	15100	15100-LGC6-E00	PUMP ASSY OIL	PUMP ASSY OIL	1	
	15133	15133-LGC6-E00	SPRKT OIL PUMP DRIVEN	SPRKT OIL PUMP DRIVEN	1	
	15141	15141-GFY6-90C	CHAIN OIL PUMP	CHAIN OIL PUMP	1	
	15333	15333-LEH6-E00	ROTOR ENGINE INNER	ROTOR ENGINE INNER	1	
	15334	15334-LEH6-E00	ROTOR ENGINE OUTER	ROTOR ENGINE OUTER	1	
	28102	28102-LEA7-E00	SHAFT STARTER REDUCTION	SHAFT STARTER REDUCTION	1	
	28110	28110-LGC6-E01	GEAR COMP. STARTING CLUTCH (63T)	GEAR COMP. STARTING CLUTCH (63T)	1	
	28120	28120-LGC6-E00	ONE WAY CLUTCH	ONE WAY CLUTCH	1	
	28130	28130-LGC6-E01	GEAR STARTER REDUCTION (52T/11T)	GEAR STARTER REDUCTION (52T/11T)	1	
	31110	31110-LGC6-E00	FLYWHEEL COMP (D402)	FLYWHEEL COMP (D402)	1	
	31120	31120-LGC6-E00	STATOR COMP (D402)	STATOR COMP.	1	
	31129	31129-LGC6-E00	STAY STATOR COMP	STAY STATOR COMP	1	
	31210	31210-LGC6-E00	MOTOR UNIT STARTER	MOTOR UNIT STARTER	1	
	32102	32102-AKB8-E01	SUB HARNESS ENGINE	SUB HARNESS ENGINE	1	
	32410	32410-AKB8-E00	CABLE. START MOTOR	CABLE. START MOTOR	1	
	32412	32412-AKB8-E00	CABLE EARTH	CABLE EARTH	1	
	90001	90001-GBHB-661	BOLT FLANGE SH 6*22	BOLT FLANGE SH 6*22	2	
	90412	90412-3K29-001	WASHER THRUST 10M/M	WASHER THRUST 10M/M	1	
	91303	91303-PUA5-E00	O-RING_9X1_5	O-RING_9X1_5	1	

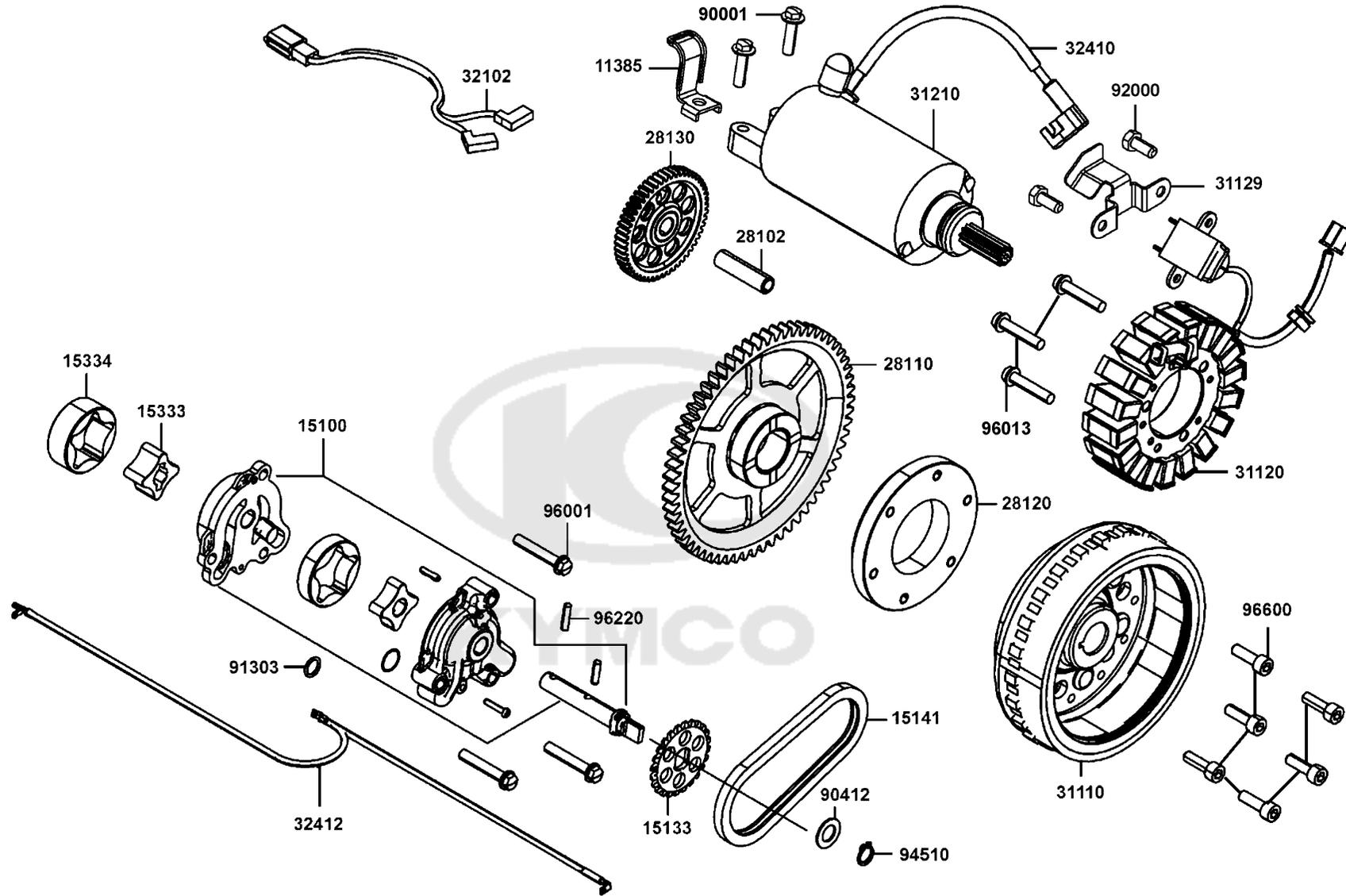

Sales mark	Ref no	Part no	Description	Reg description	Regd no	E08
92000		92000-05016-0G	BOLT HEX 5X16	BOLT HEX 5X16	2	
94510		94510-10000	CIR CLIP EX 10MM	CIR CLIP EX 10MM	1	
96001		96001-06035-06	BOLT FLANGE SH 6*35	BOLT FLANGE SH 6*35	3	
96013		96013-LGC6-E00	M6X35-8.8-ZNNIV SI	M6X35-8.8-ZNNIV SI	3	
96220		96220-40158	NEEDLE PIN 4X15.8	NEEDLE PIN 4X15.8	1	
96600		96600-06015-10	SOCKET BOLT 6X15	SOCKET BOLT 6X15	6	
						

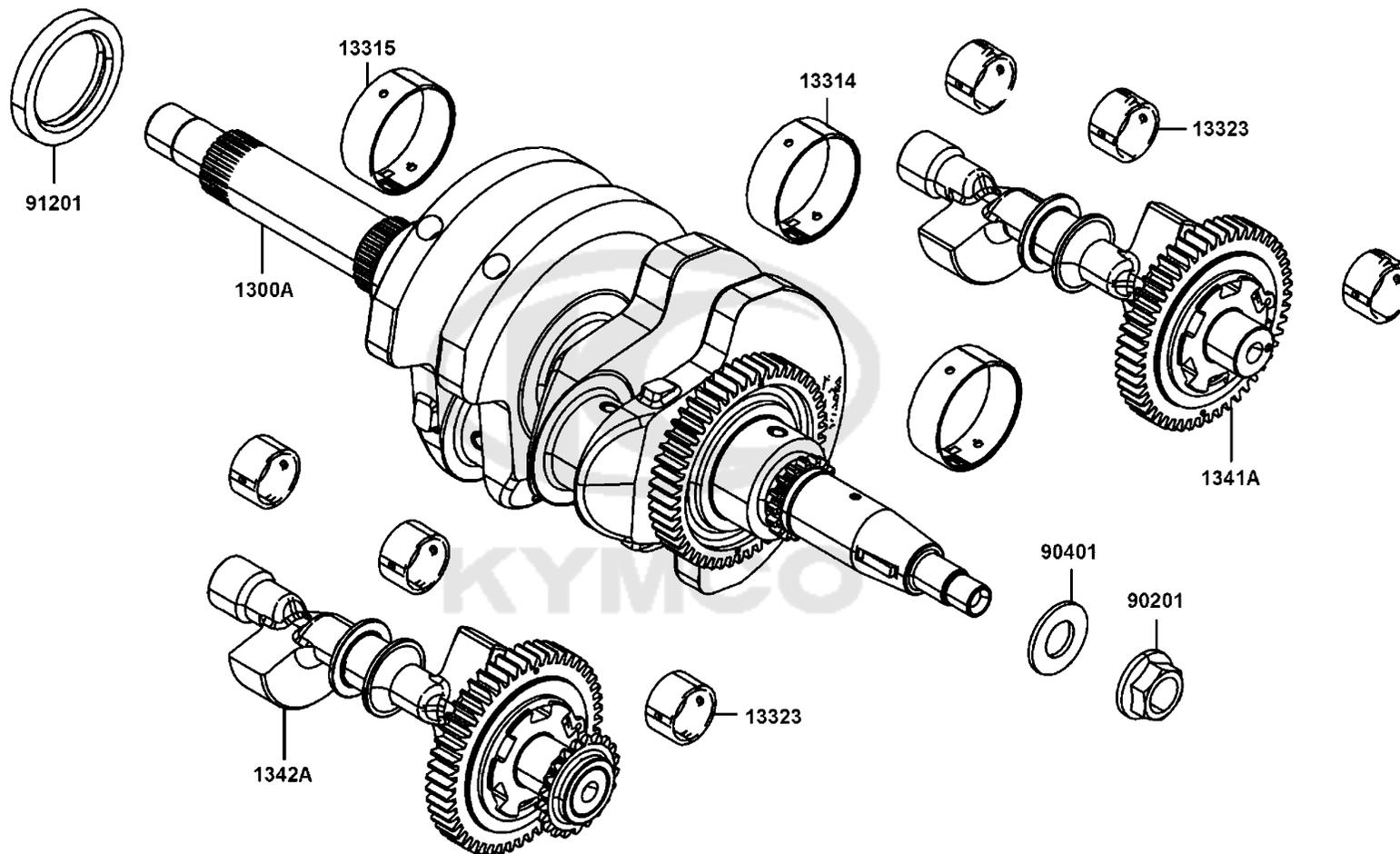

Sales mark	Ref no	Part no	Description	Reg description	Regd no	E09
	1300A	1300A-LGC6-E00	CRANK SHAFT COMP	CRANK SHAFT COMP	1	
	13314	13314-LGC6-E00-A	BEARING A CRANK SHAFT/YELLOW	BEARING A CRANK SHAFT/YELLOW	3	
	13314	13314-LGC6-E00-B	BEARING A CRANK SHAFT/BLUE	BEARING A CRANK SHAFT/BLUE	3	
	13314	13314-LGC6-E00-C	BEARING A CRANK SHAFT/RED	BEARING A CRANK SHAFT/RED	3	
	13314	13314-LGC6-E00-D	BEARING A CRANK SHAFT/GREEN	BEARING A CRANK SHAFT/GREEN	3	
	13314	13314-LGC6-E00-E	BEARING A CRANK SHAFT /BLACK	BEARING A CRANK SHAFT /BLACK	3	
	13315	13315-LGC6-E00-A	BEARING B CRANK SHAFT/ YELLOW	BEARING B CRANK SHAFT/ YELLOW	3	
	13315	13315-LGC6-E00-B	BEARING B CRANK SHAFT /BLUE	BEARING B CRANK SHAFT /BLUE	3	
	13315	13315-LGC6-E00-C	BEARING B, CRANK SHAFT/ RED	BEARING B CRANK SHAFT/ RED	3	
	13315	13315-LGC6-E00-D	BEARING B CRANK SHAFT/GREEN	BEARING B CRANK SHAFT/GREEN	3	
	13315	13315-LGC6-E00-E	BEARING B CRANK SHAFT /BLACK	BEARING B CRANK SHAFT /BLACK	3	
	13323	13323-PRB9-E00-0A	BEARING SHELL BALANCER SHAFT	BEARING SHELL BALANCER SHAFT /BROWN	12	
	13323	13323-PRB9-E00-0B	BEARING SHELL BALANCER SHAFT /	BEARING SHELL BALANCER SHAFT /	12	
	1341A	1341A-LGC6-E00	SHAFT COMP BALANCER	SHAFT COMP BALANCER	1	
	1342A	1342A-LGC6-E00	SHAFT COMP BALANCER	SHAFT COMP BALANCER	1	
	90201	90201-KHR8-75A	NUT FLANGE 14MM	NUT FLANGE 14MM	1	
	90401	90401-KKJ9-001	WASHER THRUST 14*28*2	WASHER THRUST 14*28*2	1	
	91201	91201-LKF5-E00	OIL SEAL 38*50*7	OIL SEAL 38*50*7	1	

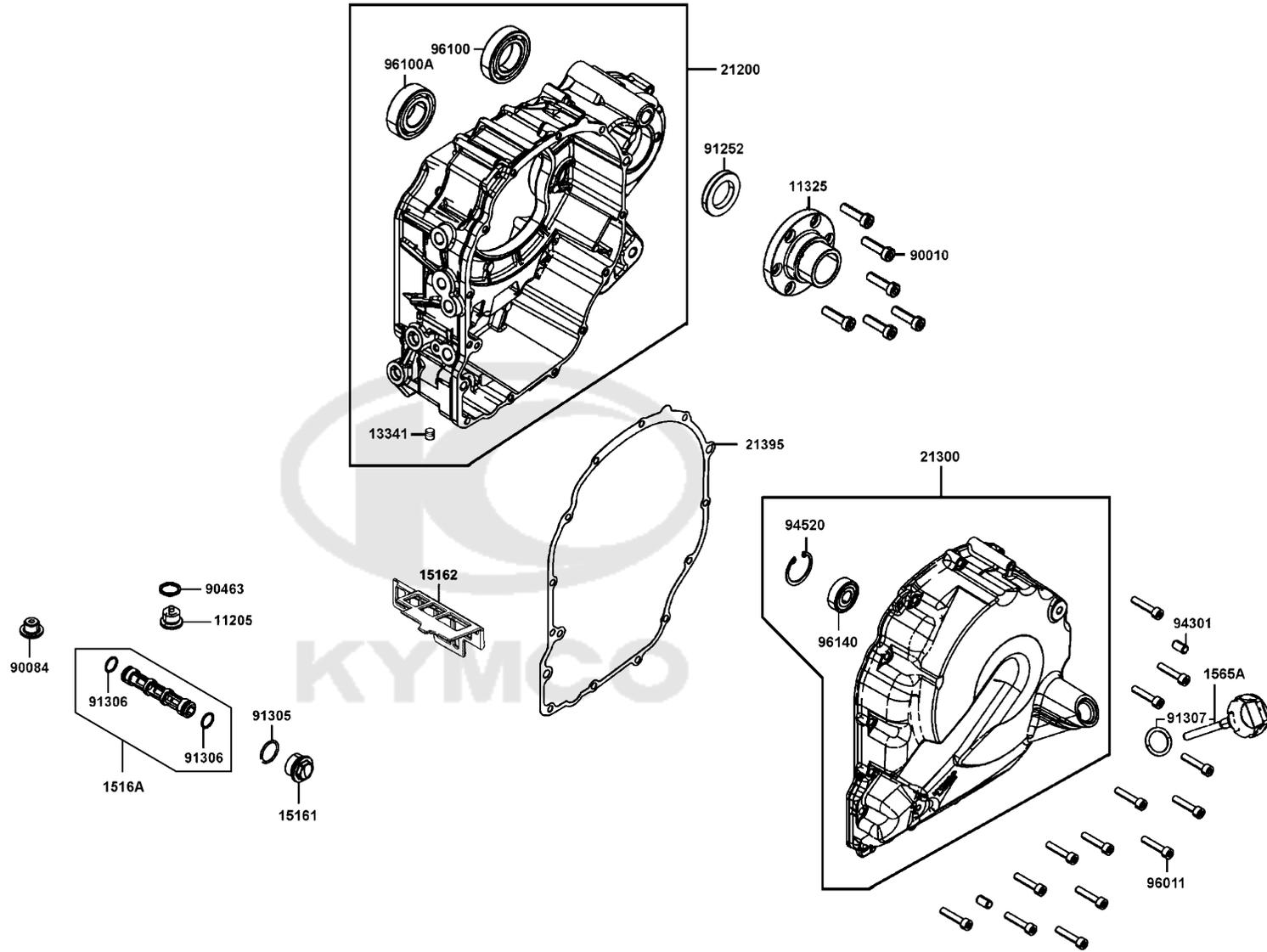

Sales mark	Ref no	Part no	Description	Reg description	Regd no	E10
	11205	11205-PSA6-E00	MAGNETIC SCREW M16*1.5	MAGNETIC SCREW M16*1.5	1	
	11325	11325-LGC6-E02	PIVOT L SWING ARM	PIVOT L SWING ARM	1	
	13341	13341-LGC6-E00	GRUB SCREW M6X6	GRUB SCREW M6 X 7	1	
	15161	15161-LGC6-E00	PLUG SCREW SECTION FILTER	PLUG SCREW SECTION FILTER	1	
	15162	15162-LGC6-E01	SUCTION FILTER, CRANK SIDE	SUCTION FILTER, CRANK SIDE	1	
	1516A	1516A-LGC6-E00	SUCTION FILTER ASSY CRANK SIDE	SUCTION FILTER ASSY CRANK SIDE	1	
	1565A	1565A-AGJ5-E00	GAUGE OIL LEVEL ASSY	GAUGE OIL LEVEL ASSY	1	
	21200	21200-LGC6-306	CASE SET L MISSION	CASE SET L MISSION	1	
	21300	21300-LGC6-305	COVER SET MISSION	COVER SET MISSION	1	
	21395	21395-LGC6-E00	GASKET MISSION COVER	GASKET MISSION COVER	1	
	90010	90010-KKE5-E01	SPOCKET BOLT 8X30	SPOCKET BOLT 8X30	3	
	90084	90084-KKE5-E00	CAPE OIL CHANNEL	CAPE OIL CHANNEL	1	
	90463	90463-PUA5-E00	WASHER DIN 7603-A16*20-A1	WASHER DIN 7603-A16*20-A1	1	
	91252	91252-LGC6-E00	OIL SEAL 28X45X7	OIL SEAL 28X45X7	1	
	91305	91305-LEH6-E00	O RING 19.8x1.9	O RING 19.8x1.9	1	
	91306	91306-PUA5-E00	O-RING 13*1.5	O-RING 13*1.5	2	
	91307	91307-0E35-001	O RING 18*3	O RING 18*3	1	
	94301	94301-08140	DOWEL PIN 8*14	DOWEL PIN 8*14	2	
	94520	94520-32180	CIR CLIP IN 32	CIR CLIP IN 32	1	
	96011	96011-PRA1-E00	BOLT M6*30	BOLT M6*30	14	

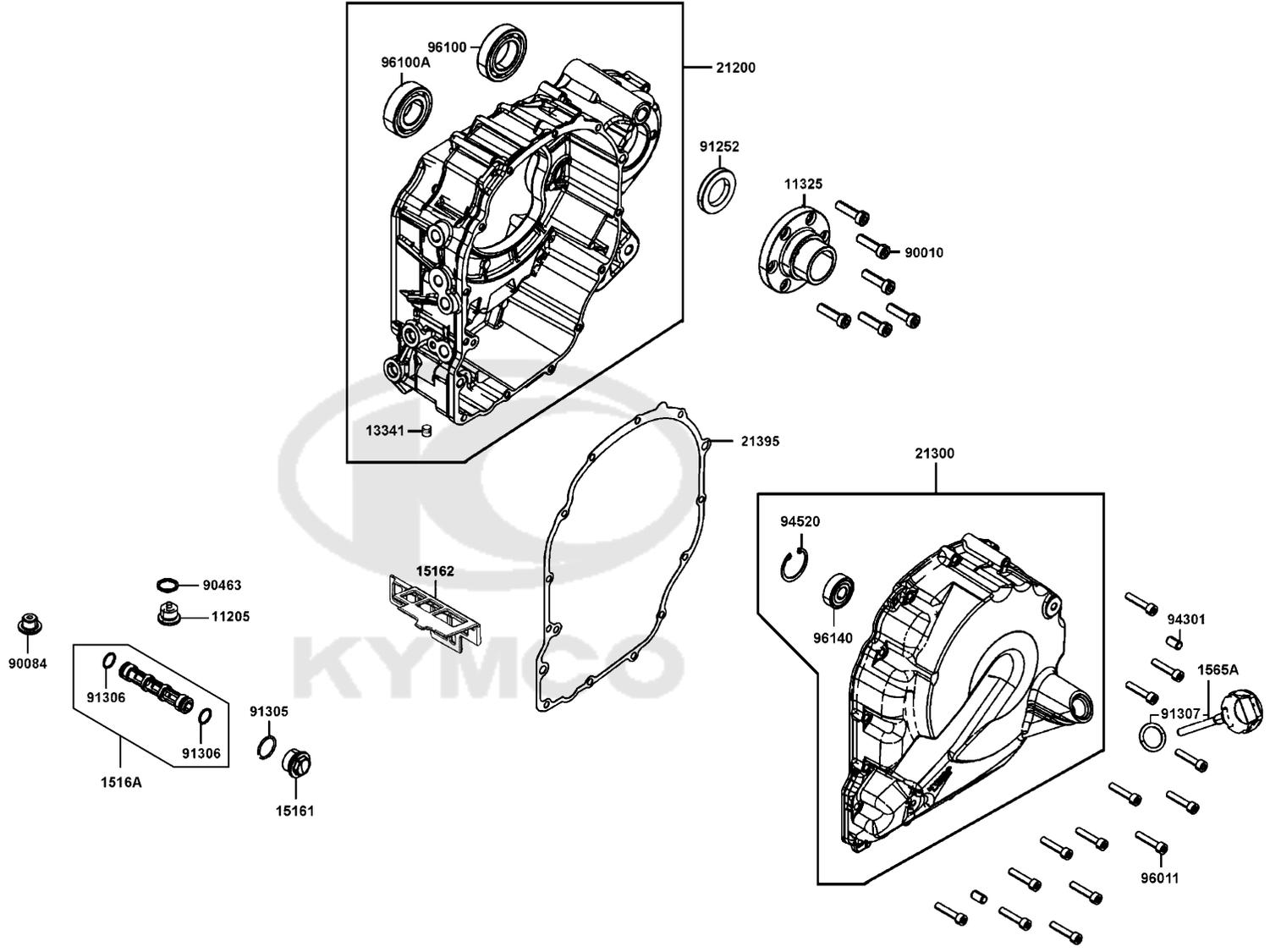

Sales mark	Ref no	Part no	Description	Reg description	Regd no	E10
------------	--------	---------	-------------	-----------------	---------	------------

96100		96100-60060-00	BEARING BALL RADIAL 6006	BEARING BALL RADIAL 6006	1	
96100A		96100-62050-00	BEARING BALL RADIAL 6205	BEARING BALL RADIAL 6205	1	
96140		96140-62010	BEARING BALL RADIAL 6201 LU	BEARING BALL RADIAL 6201 LU	1	



F01

Head Light

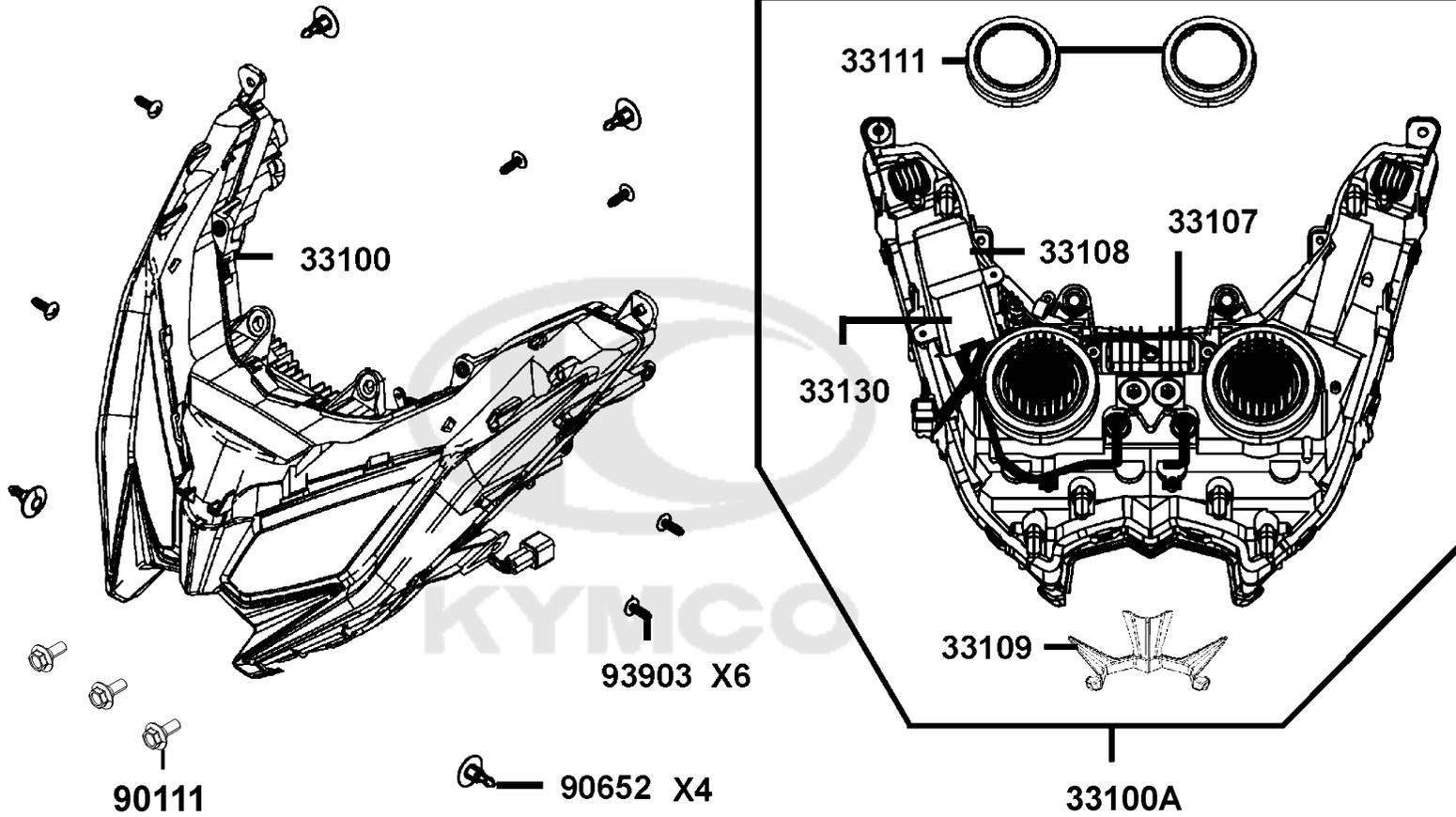

Sales mark	Ref no	Part no	Description	Reg description	Regd no	F01
	33100	33100-AKB8-305	LIGHT ASSY HEAD	LIGHT ASSY HEAD	1	
	33100A	33100-AKB8-E00	LIGHT ASSY HEAD	LIGHT ASSY HEAD	1	
	33107	33107-AKB8-E00	DRIVE PCB ASSY POSITION LIGHT	DRIVE PCB ASSY POSITION LIGHT	1	
	33108	33108-LGC6-E00	DRIVE PCB ASSY HEAD LIGHT	DRIVE PCB ASSY HEAD LIGHT	1	
**	33109	33109-AKB8-E00	OUTER RS HEAD LIGHT	OUTER RS HEAD LIGHT	1	
	33111	33111-LGC6-E00	COVER RUBBER	COVER RUBBER	2	
	33130	33130-AKB8-E00	SOCKET COMP HEAD LIGHT	SOCKET COMP HEAD LIGHT	1	
	90111	90111-LGE3-910	BOLT FLANGE 6MM	BOLT FLANGE 6MM	2	
	90652	90652-LCA4-E00	CLIP MUDGUARD	CLIP MUDGUARD	4	
	93903	93903-35260	SCREW TAPPING 5*12	SCREW TAPPING 5*12	6	



F02

Speedometer

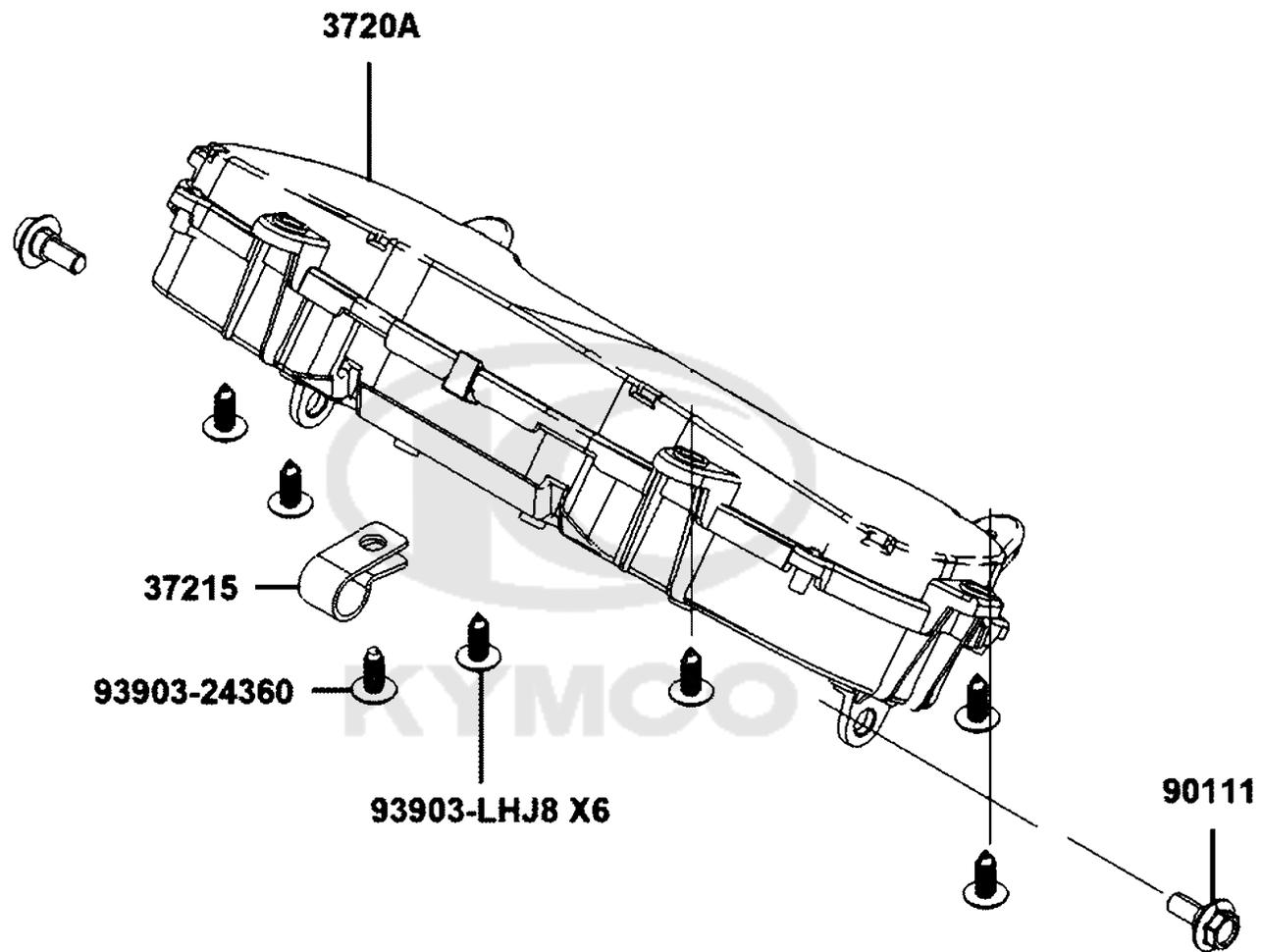

Sales mark	Ref no	Part no	Description	Reg description	Regd no	F02
------------	--------	---------	-------------	-----------------	---------	------------

3720A	3720A-AKB8-E02	3720A-AKB8-E02	METER SET SPEED	METER SET SPEED	1	
37215	37215-LGM9-900	37215-LGM9-900	CLAMP	CLAMP	1	
90111	90111-LGE3-910	90111-LGE3-910	BOLT FLANGE 6MM	BOLT FLANGE 6MM	3	
93903-24360	93903-24360	93903-24360	SCREW TAPPING 4*12	SCREW TAPPING 4*12	1	
93903-LHJ8	93903-LHJ8-910	93903-LHJ8-910	SCREW TAPPING 5*14	SCREW TAPPING 5*14	6	



F03

Handle SteeringHandle Cover

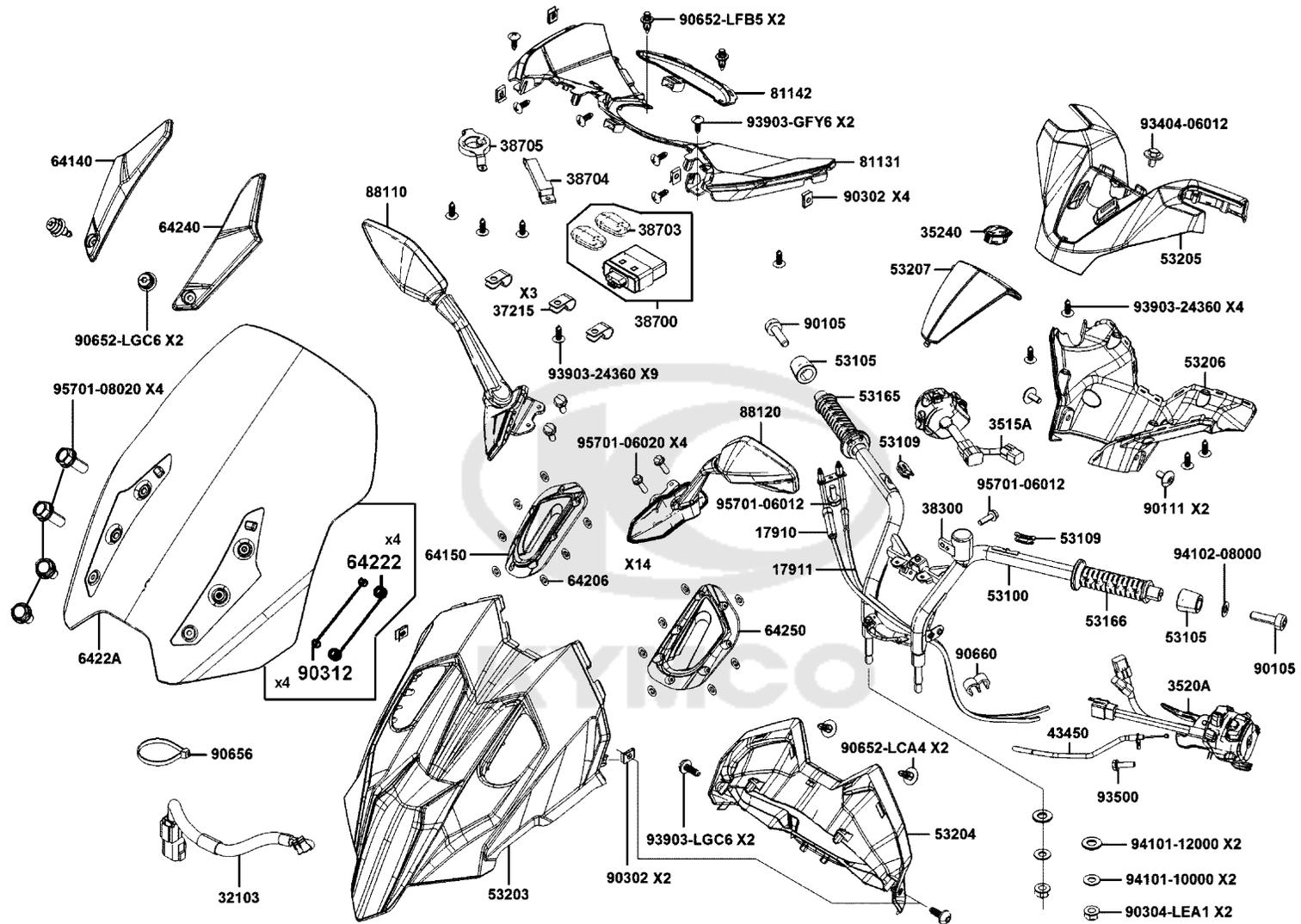

Sales mark	Ref no	Part no	Description	Reg description	Regd no	F03
	17910	17910-AKB8-E00	CABLE COMP THROT	CABLE COMP THROT	1	
	17911	17911-AKB8-E00	CABLE B COMP THROT	CABLE B COMP THROT	1	
	32103	32103-AKB8-E01	SUB HARNESS HEATER	SUB HARNESS HEATER	1	
	3515A	3515A-AKB8-E01	SW ASSY RH HANDLE COMP	SW ASSY RH HANDLE COMP	1	
	3520A	3520A-AKB8-E01	SW ASSY LH HANDLE COMP	SW ASSY LH HANDLE COMP	1	
	35240	35240-AKB8-E01	SW UNIT.,TRIGGER	SW UNIT.,TRIGGER	1	
	37215	37215-LKG2-900	CLAMP	CLAMP (11)	3	
	38300	38300-KKE5-E00	RELAY COMP WINKER	RELAY COMP. WINKER	1	
	38700	38700-AGJ5-305	CONTROLLER SET KEYLESS	CONTROLLER SET KEYLESS	1	
	38703	38703-AGJ5-E00	REMOTE CONTROL	REMOTE CONTROL	1	
	38704	38704-AGE2-E00	ANTENNA COMP LONG RANGE	ANTENNA COMP LONG RANGE	1	
	38705	38705-AGJ5-E00	ANTENNA COMP SHORT RANGE	ANTENNA COMP SHORT RANGE	1	
	43450	43450-AKB8-E00	CABLE COMP PARKING	CABLE COMP PARKING	1	
	53100	53100-AKB8-E00	HANDLE COMP STRG	HANDLE COMP STRG	1	
	53105	53105-LGC6-E00	END HANDLE	END HANDLE	2	
	53109	53109-LGC6-E00	GROMMET HANDLE BAR	GROMMET HANDLE BAR	2	
	53165	53165-LGC6-E01	GRIP R HANDLE HEATED	GRIP R HANDLE HEATED	1	
	53166	53166-LGC6-E01	GRIP L HANDLE HEATED	GRIP L HANDLE HEATED	1	
**	53203	53203-AKB8-E00	COVER FR MERTER	COVER FR MERTER	1	
**	53204	53204-AKB8-E00	COVER METER	COVER METER	1	

Sales mark	Ref no	Part no	Description	Reg description	Regd no	F03
**	53205	53205-AKB8-E00	COVER HANDLE UP	COVER HANDLE UP	1	
**	53206	53206-AKB8-E00	COVER HANDLE LOW	COVER HANDLE LOW	1	
**	53207	53207-AKB8-E00	TOP COVER HANDLE COVER	TOP COVER HANDLE COVER	1	
**	64140	64140-AKB8-E00	COVER A,R WIND SCREEN	COVER A,R WIND SCREEN	1	
**	64150	64150-AKB8-E00	RUBBER R WIND SCREEN	RUBBER R WIND SCREEN	1	
	64206	64206-MLJ0-001	NUT SPEED 4MM	NUT SPEED 4MM	14	
	64222	64222-LLJ3-E00	RUBBER WIND SCREEN	RUBBER WIND SCREEN	2	
**	6422A	6422A-AKB8-E00	WIND SCRRN ASSY	WIND SCRRN ASSY	1	
**	64240	64240-AKB8-E00	COVER A L WIND SCREEN	COVER A L WIND SCREEN	1	
**	64250	64250-AKB8-E00	RUBBER L WIND SCREEN	RUBBER L WIND SCREEN	1	
**	81131	81131-AKB8-E00	LEG SHIELD UP	LEG SHIELD UP	1	
**	81142	81142-AKB8-E00	LEG SHIELD MID	LEG SHIELD MID	1	
	88110	88110-AKB8-E00	MIRROR ASSY R BACK	MIRROR ASSY R BACK	1	
	88120	88120-AKB8-E00	MIRROR ASSY L BACK	MIRROR ASSY L BACK	1	
	90105	90105-KFC2-900	BOLT WASH 8*32	BOLT WASH 8*32	2	
	90111	90111-LGC6-E01	SCREW PAN 6X14	SCREW PAN 6X14	2	
	90302	90302-SDA4-004	NUT SPRING 4MM	NUT SPRING 4MM	6	
	90304-LEA1	90304-LEA1-900	NUT U FLANGE 10MM	NUT U FLANGE 10MM	2	
	90312	90312-LLJ3-E00	COLLAR WIND SCREEN	COLLAR WIND SCREEN	4	
	90652-LCA4	90652-LCA4-E00	CLIP MUDGUARD	CLIP MUDGUARD	2	

F03

Handle SteeringHandle Cover

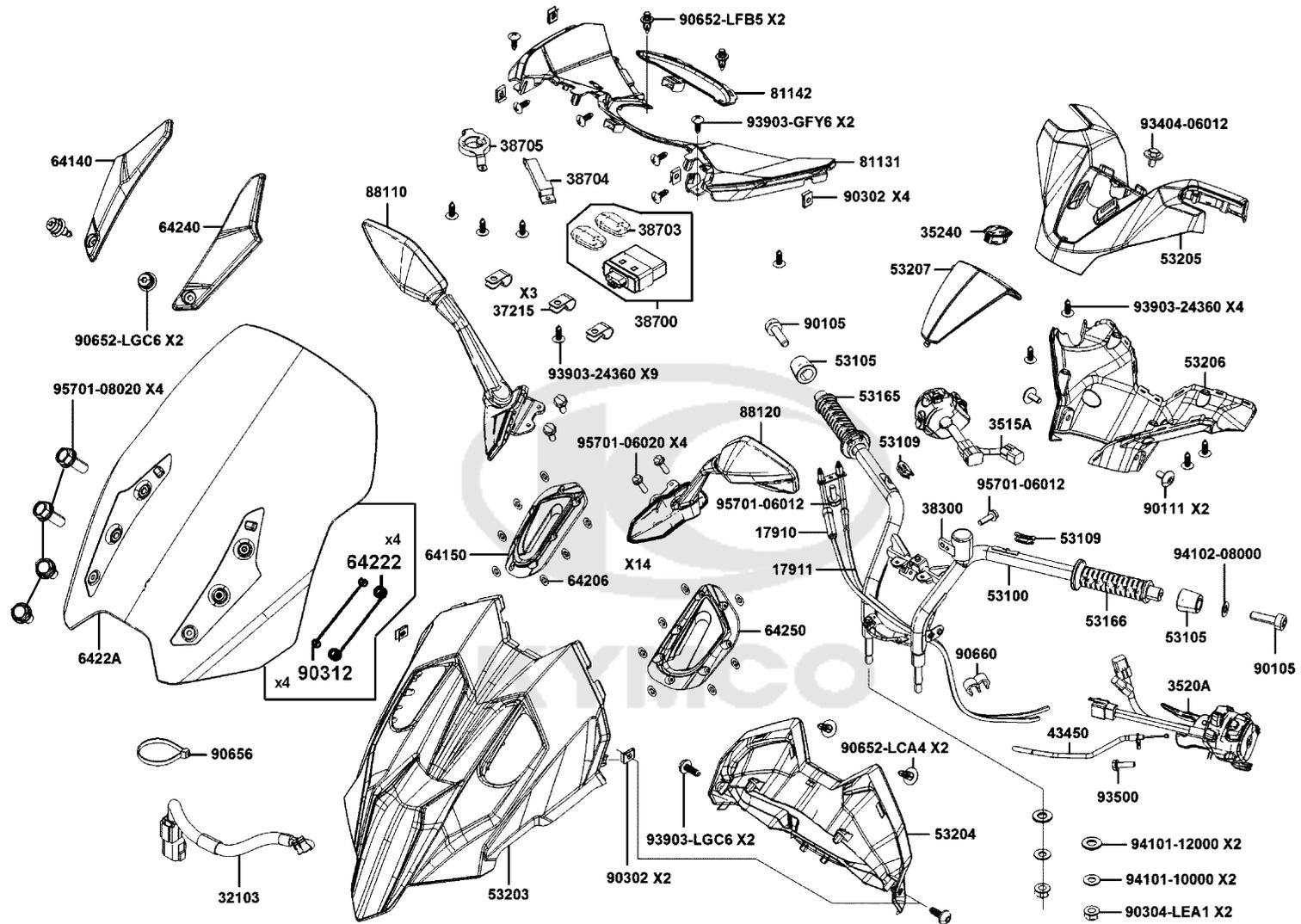

Sales mark	Ref no	Part no	Description	Reg description	Regd no	F03
90652-LFB5		90652-LFB5-900	CLIP MUDGUARD	CLIP MUDGUARD	2	
90652-LGC6		90652-LGC6-E00	PUSH RIVET	PUSH RIVET	2	
90656		90656-KCBC-900	BAND OIL HANDLE 8X146	BAND OIL HANDLE 8X146	2	
90660		90660-PWA2-900	CLAMP TUBE	CLAMP TUBE	1	
93404-06012		93404-06012-06	BOLT WASHER 6X12	BOLT WASHER 6X12	1	
93500		93500-05010-0F	SCREW PAN 5X10	SCREW PAN 5X10	1	
93903-24360		93903-24360	SCREW TAPPING 4*12	SCREW TAPPING 4*12	13	
93903-GFY6		93903-GFY6-900	SCREW TAPPING 4*14	SCREW TAPPING 4*14	2	
93903-LGC6		93903-LGC6-E01	SCREW TAPPING	SCREW TAPPING	2	
94101-10000		94101-10000	WASHER PLAIN 10MM	WASHER PLAIN 10MM	2	
94101-12000		94101-12000	WASHER PLAIN 12 MM	WASHER PLAIN 12 MM	2	
94102-08000		94102-08000	WASHER PLAIN 8MM	WASHER PLAIN 8MM	1	
95701-06012		95701-06012-06	BOLT FLANGE 6X12	BOLT FLANGE 6X12	2	
95701-06020		95701-06020-06	BOLT FLANGE 6*20	BOLT FLANGE 6*20	4	
95701-08020		95701-08020-06	BOLT FLANGE 8*20MM **07 C.2005.07.01	BOLT FLANGE 8*20MM **07 C.2005.07.01	4	

Sales mark	Ref no	Part no	Description	Reg description	Regd no	F04
	35340	35340-AGJ5-E00	SW ASS'Y..FR STOP	SW ASS'Y..FR STOP	2	
	35380	35380-LEA2-900	SENSOR ANGLE DETECT	SENSOR ANGLE DETECT	1	
	43126	43126-AKB8-E00	HOSE ASSY RR BRK	HOSE ASSY RR BRK	1	
	43127	43127-AKB8-E00	HOSE ASSY RR BRK	HOSE ASSY RR BRK	1	
	4335A	4335A-LGC6-E00	BLEEDER ASSY	BLEEDER ASSY	3	
**	43530	43530-AGJ5-305	CYLN SET RR MASTER	CYLN SET RR MASTER	1	
	45126	45126-AKB8-E00	HOSE ASSY FR BRK	HOSE ASSY FR BRK	1	
	45127	45127-AKB8-E00	HOSE ASSY M/C FR BRK	HOSE ASSY M/C FR BRK	1	
	45513	45513-AGJ5-E00	CAP M/C	CAP M/C	1	
	45517	45517-KFAF-900	HOLDER M/C	HOLDER M/C	2	
	45520	45520-KKA8-900	DIAPHRAGM	DIAPHRAGM	1	
	45521	45521-LEA7-E00	PLATE DIAPHRAGM	PLATE DIAPHRAGM	2	
	45530	45530-AKB8-305	M/C SET FR RH	M/C SET FR RH	1	
	49110	49110-AKB8-E00	STAY ABS	STAY ABS	1	
	49200	49200-AKB8-306	MODULATOR ASSY	MODULATOR ASSY	1	
	49211	49211-LFH1-E00	RUBBER BUSH	RUBBER BUSH	2	
	53175	53175-AGJ5-E00	LEVER R STRG HANDLE	LEVER R STRG HANDLE	1	
	53178	53178-AGJ5-E00	LEVER L STRG HANDLE	LEVER L STRG HANDLE	1	
	90113	90113-LGE5-E01	BOLT FLANGE 6X20 ABS	BOLT FLANGE 6X20 ABS	1	
	90145-LEA3	90145-LEA3-E00	OIL BOLT 10*22	OIL BOLT 10*22	2	

F04

Brake Master Cylinder

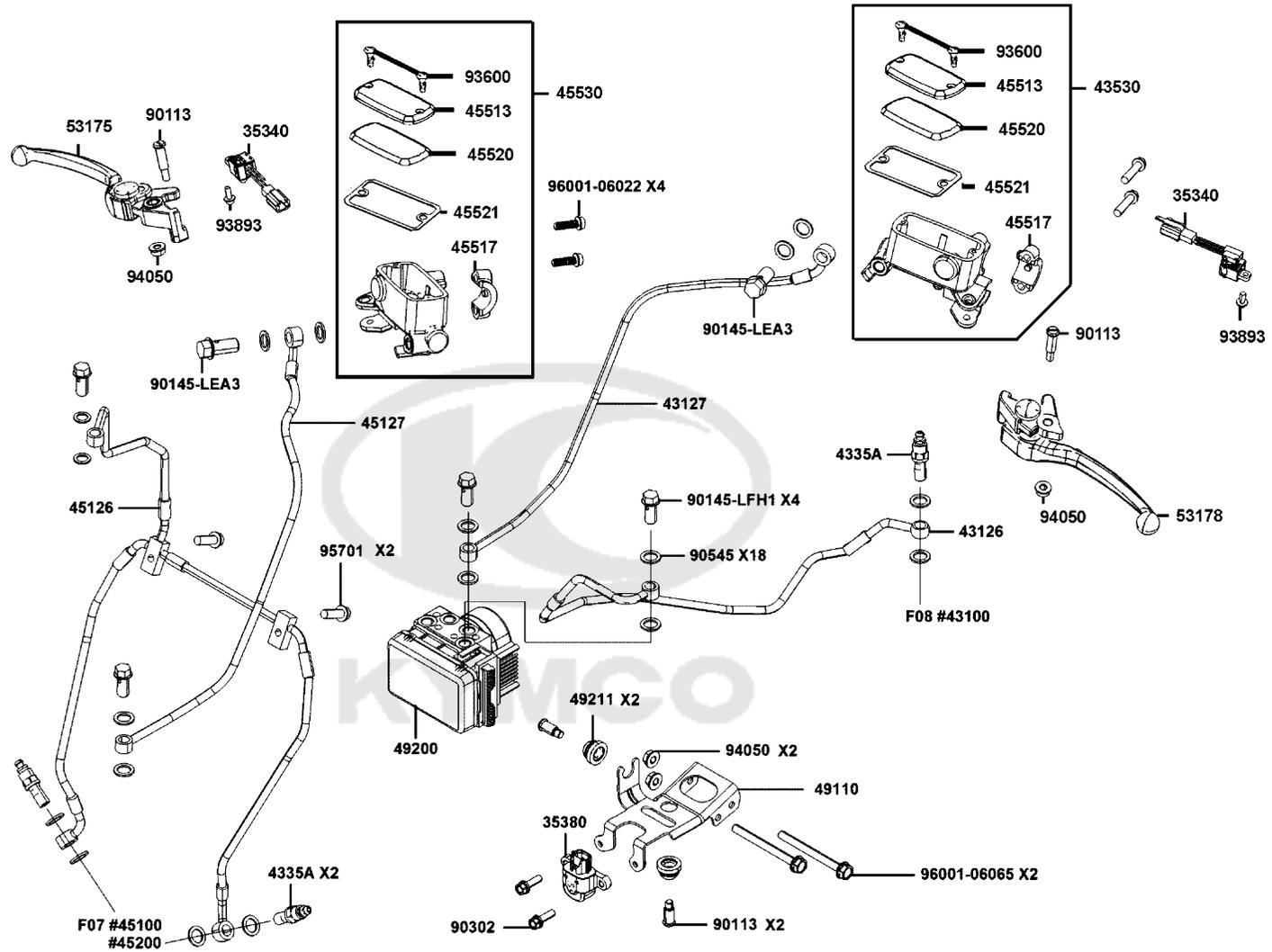

Sales mark	Ref no	Part no	Description	Reg description	Regd no	F04
90145-LFH1	90145-LFH1	90145-LFH1-E00	OIL BOLT 10x22	OIL BOLT 10x22	4	
90302	90302	90302-GFY6-940	BOLT-WASH 5*16	BOLT-WASH 5*16	2	
90545	90545	90545-3L00-001	WASHER OIL BOLT	WASHER OIL BOLT	18	
93600	93600	93600-04012-1G	SCREW FLAT 4*12	SCREW FLAT 4*12	4	
93893	93893	93893-04012-18	SCREW WASHER 4*12	SCREW WASHER 4*12	2	
94050	94050	94050-06060	NUT FLANGE 6MM	NUT FLANGE 6MM	2	
95701	95701	95701-06020-06	BOLT FLANGE 6*20	BOLT FLANGE 6*20	2	
96001-06022	96001	96001-06022-06	BOLT FLANGE SH 6X22	BOLT FLANGE SH 6X22	4	
96001-06065	96001	96001-06065-06	BOLT FLANGE SH 6X65	BOLT FLANGE SH 6X65	2	



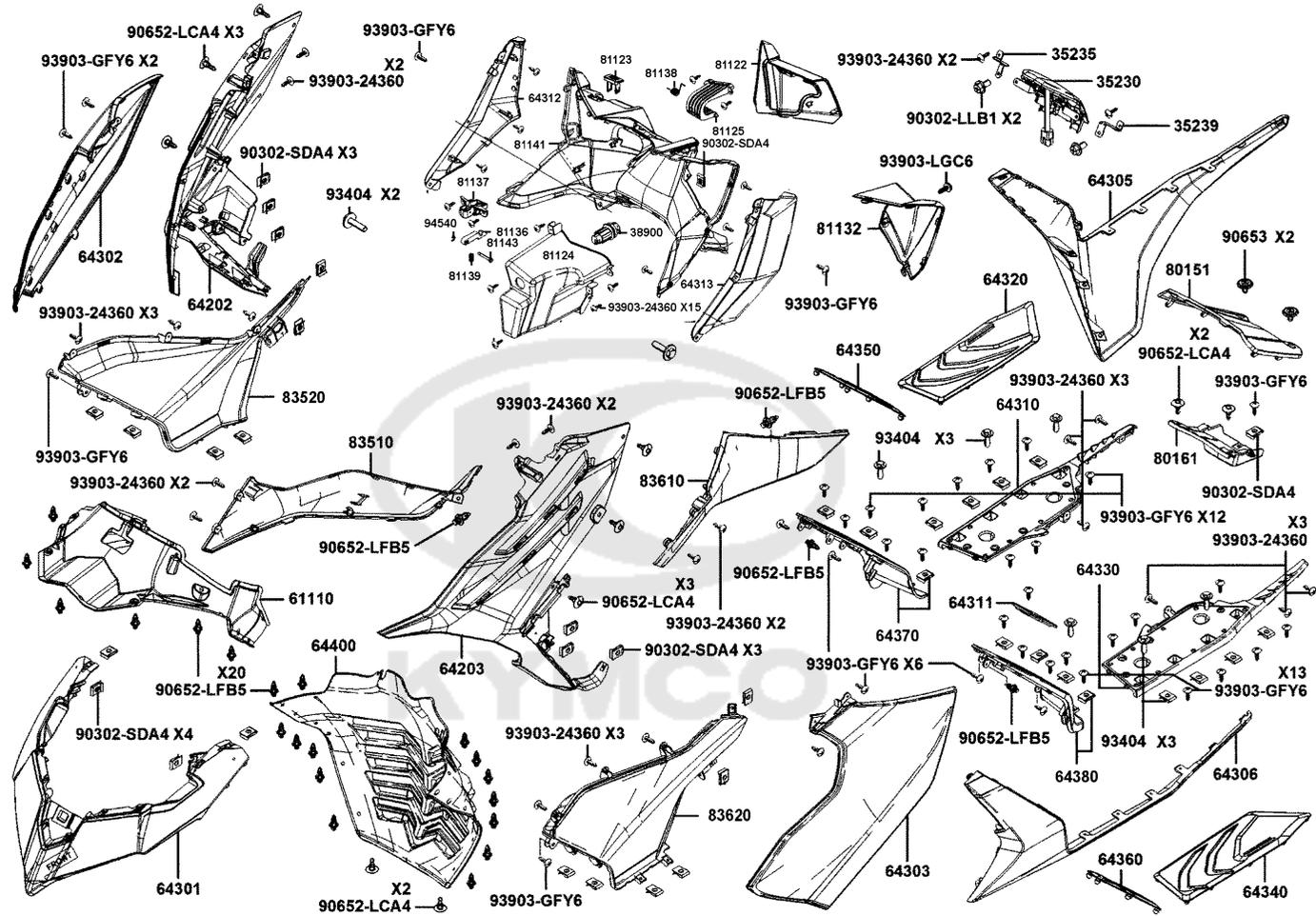

Sales mark	Ref no	Part no	Description	Reg description	Regd no	F05
	35230	35230-AKB8-E00	SW ASSY MULTI FUNCTION	SW ASSY MULTI FUNCTION	1	
	35235	35235-AKB8-E00	STAY MULTI-FUNCTION SW RH	STAY MULTI-FUNCTION SW RH	1	
	35239	35239-AKB8-E00	STAY MULTI-FUNCTION SW LH	STAY MULTI-FUNCTION SW LH	1	
	38900	38900-ACD5-E00	CONTROLLER USB CHARGER	CONTROLLER USB CHARGER	1	
**	61110	61110-AKB8-E00	FENDER FRONT INNER	FENDER FRONT INNER	1	
**	64202	64202-AKB8-E00	MOLDING C R SIDE	MOLDING C R SIDE	1	
**	64203	64203-AKB8-E00	MOLDING C L SIDE	MOLDING C L SIDE	1	
**	64301	64301-AKB8-E00	COVER A FRONT	COVER A FRONT	1	
**	64302	64302-AKB8-E00	MOLDING A R SIDE	MOLDING A R SIDE	1	
**	64303	64303-AKB8-E00	MOLDING A L SIDE	MOLDING A L SIDE	1	
**	64305	64305-AKB8-E00	SKIRT R SIDE	SKIRT R SIDE	1	
**	64306	64306-AKB8-E00	SKIRT L SIDE	SKIRT L SIDE	1	
	64310	64310-AKB8-E00	PANEL A ASSY R FLOOR	PANEL A ASSY R FLOOR	1	
**	64311	64311-AKB8-E00	LID RESERVE TANK	LID RESERVE TANK	1	
**	64312	64312-AKB8-E00	MOLDING B R SIDE	MOLDING B R SIDE	1	
**	64313	64313-AKB8-E00	MOLDING B L SIDE	MOLDING B L SIDE	1	
**	64320	64320-AKB8-E00	MAT R FLOOR	MAT R FLOOR	1	
**	64330	64330-AKB8-E00	PANEL A L FLOOR	PANEL A L FLOOR	1	
**	64340	64340-AKB8-E00	MAT L FLOOR	MAT L FLOOR	1	
**	64350	64350-AKB8-E00	MAT R LEG SHIELD	MAT R LEG SHIELD	1	

Sales mark	Ref no	Part no	Description	Reg description	Regd no	F05
**	64360	64360-AKB8-E00	MAT L LEG SHIELD	MAT L LEG SHIELD	1	
**	64370	64370-AKB8-E00	PANEL B ASSY R FLOOR	PANEL B ASSY R FLOOR	1	
**	64380	64380-AKB8-E00	PANEL B ASSY L FLOOR	PANEL B ASSY L FLOOR	1	
	64400	64400-AKB8-E00	COWL UNDER	COWL UNDER	1	
	80151	80151-AKB8-E00	COVER A CENTER	COVER A CENTER	1	
	80161	80161-AKB8-E00	COVER B CENTER	COVER B CENTER	1	
	81122	81122-AKB8-E00	LIDR FR INNER BOX	LIDR FR INNER BOX	1	
	81123	81123-AKB8-E00	BUTTOM R FR INNER BOX	BUTTOM R FR INNER BOX	1	
	81124	81124-AKB8-E00	BOX R FR INNER BOX	BOX R FR INNER BOX	1	
	81125	81125-AKB8-E00	HINGE R FR INNER BOX	HINGE R FR INNER BOX	1	
	81132	81132-AKB8-E00	LID L FR INNER BOX	LID L FR INNER BOX	1	
	81136	81136-AKB8-E00	STOP BUTTOM	STOP BUTTOM	1	
	81137	81137-AKB8-E00	HOLDER BUTTOM	HOLDER BUTTOM	1	
	81138	81138-AKB8-E00	SPRING C R FR INNER BOX	SPRING C R FR INNER BOX	1	
	81139	81139-AKB8-E00	SPRING B R FR INNER BOX	SPRING B R FR INNER BOX	1	
	81141	81141-AKB8-E00	LEG SHIELD LOW	LEG SHIELD LOW	1	
	81143	81143-AKB8-E00	PIN BUTTOM	PIN BUTTOM	1	
**	83510	83510-AKB8-E00	BOARD B R SIDE	BOARD B R SIDE	1	
**	83520	83520-AKB8-E00	BOARD A ASSY R SIDE	BOARD A ASSY R SIDE	1	
**	83610	83610-AKB8-E00	BOARD B L SIDE	BOARD B L SIDE	1	

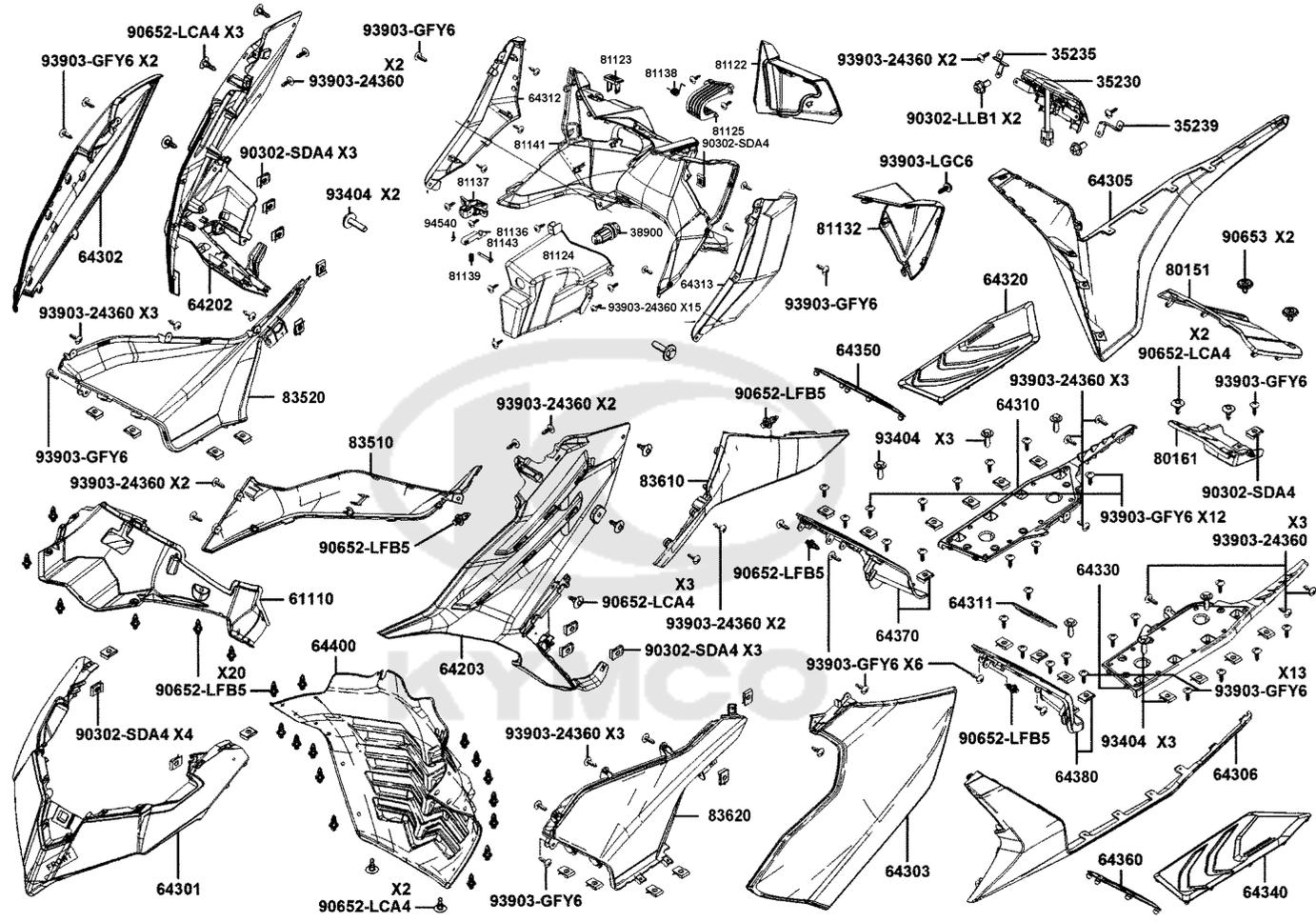

Sales mark	Ref no	Part no	Description	Reg description	Regd no	F05
**	83620	83620-AKB8-E00	BOARD A ASSY L SID	BOARD A ASSY L SID	1	
	90302-LLB1	90302-LLB1-E00	BOLT-WASHER 5*12	BOLT-WASHER 5*12	2	
	90302-SDA4	90302-SDA4-004	NUT SPRING 4MM	NUT SPRING 4MM	23	
	90652-LCA4	90652-LCA4-E00	CLIP MUDGUARD	CLIP MUDGUARD	10	
	90652-LFB5	90652-LFB5-900	CLIP MUDGUARD	CLIP MUDGUARD	24	
	90653	90653-LGC6-E00	CLIP MUDGUARD	CLIP MUDGUARD	2	
	93404	93404-06012-06	BOLT WASHER 6X12	BOLT WASHER 6X12	8	
	93903-24360	93903-24360	SCREW TAPPING 4*12	SCREW TAPPING 4*12	37	
	93903-GFY6	93903-GFY6-900	SCREW TAPPING 4*14	SCREW TAPPING 4*14	38	
	93903-LGC6	93903-LGC6-E01	SCREW TAPPING	SCREW TAPPING	1	
	94540	94540-03029	E CLIP COLLAR STOPPER	E CLIP COLLAR STOPPER	1	

F06

Front Cushion

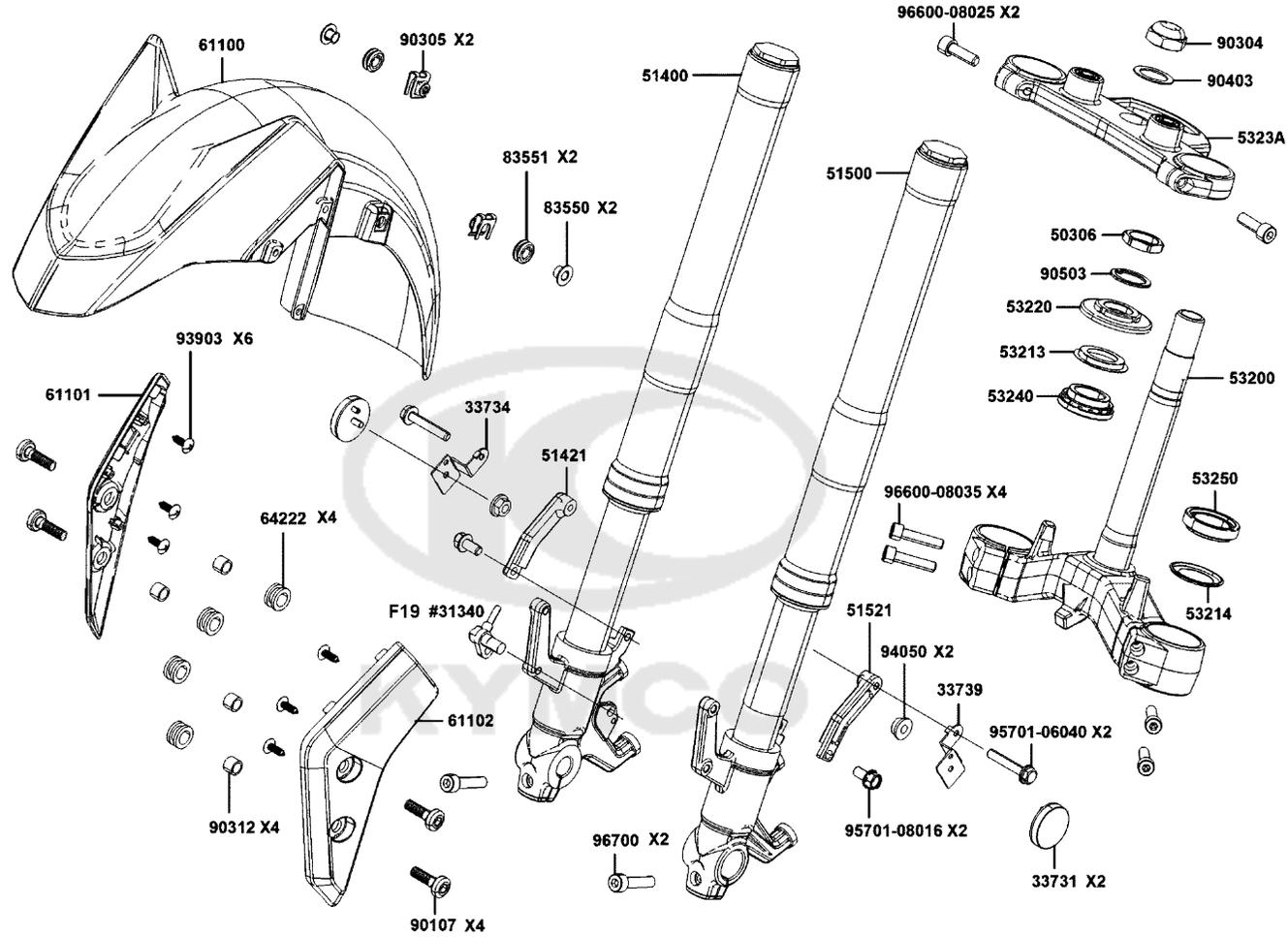

Sales mark	Ref no	Part no	Description	Reg description	Regd no	F06
	33731	33731-LHJ8-900	REFLEX REFLECTOR SIDE	REFLEX REFLECTOR. SIDE	2	
	33734	33734-LGC6-E00	STAY RH REFLEX REFLECTOR	STAY RH REFLEX REFLECTOR	1	
	33739	33739-LGC6-E00	STAY LH REFLEX REFLECTOR	STAY LH REFLEX REFLECTOR	1	
	50306	50306-AKB8-E00	NUT STRG STEM LOCK	NUT STRG STEM LOCK	1	
**	51400	51400-LGC6-E00	FORK ASSY FR R	FORK ASSY FR R	1	
**	51421	51421-LGC6-E00	STAY FR FENDER R (Mat Black)	STAY FR FENDER R (Mat Black)	1	
**	51500	51500-LGC6-E00	FORK ASSY FR L	FORK ASSY FR L	1	
**	51521	51521-LGC6-E00	STAY FR FENDER L	STAY FR FENDER L	1	
	53200	53200-AKB8-E00	STEM COMP STRG	STEM COMP STRG	1	
	53213	53213-AKB8-E00	DUST SEAL STRG HEAD TOP	DUST SEAL STRG HEAD TOP	1	
	53214	53214-LBA2-E00	DUST SEAL STRG (HEAD)	DUST SEAL STRG (HEAD)	1	
	53220	53220-AKB8-E00	THREAD COMP STRG HEAD TOP	THREAD COMP STRG HEAD TOP	1	
	5323A	5323A-AKB8-E00	BRIDGE ASSY FR FORK	BRIDGE ASSY FR FORK	1	
	53240	53240-AKB8-E00	BEARING TOP STRG	BEARING TOP STRG	1	
	53250	53250-LEA7-90A	BEARING BOT STRG (mark:TP1)	BEARING BOT STRG	1	
**	61100	61100-LGC6-E00	FENDER A FRONT	FENDER A FRONT	1	
**	61101	61101-AKB8-E00	FENDER COVER R SIDE	FENDER COVER R SIDE	1	
**	61102	61102-AKB8-E00	FENDER COVER L SIDE	FENDER COVER L SIDE	1	
	64222	64222-LLJ3-E00	RUBBER WIND SCREEN	RUBBER WIND SCREEN	4	
	83550	83550-KEC8-900	COLLAR	COLLAR	2	

Sales mark	Ref no	Part no	Description	Reg description	Regd no	F06
83551		83551-KEC8-900	GROMMET COVER	GROMMET COVER	2	
90107		90107-LEA7-E00	BOLT SPECIAL 8MM	BOLT SPECIAL 8MM	4	
90304		90304-AKB8-E00	NUT STRG STEM	NUT STRG STEM	1	
90305		90305-LBA2-E00	NUT CLIP 6MM	NUT CLIP 6MM	2	
90312		90312-LLJ3-E00	COLLAR WIND SCREEN	COLLAR WIND SCREEN	4	
90403		90403-AKB8-E00	WASHER 28.5X40X1.5	WASHER 28.5X40X1.5	1	
90503		90503-AKB8-E00	WASHER STRG STEM NUT	WASHER STRG STEM NUT	1	
93903		93903-24360	SCREW TAPPING 4*12	SCREW TAPPING 4*12	6	
94050		94050-06060	NUT FLANGE 6MM	NUT FLANGE 6MM	2	
95701-06040		95701-06040-06	BOLT FLANGE 6*40	BOLT FLANGE 6*40	2	
95701-08016		95701-08016-06	BOLT FLANGE 8*16	BOLT FLANGE 8*16	2	
96600-08025		96600-08025-06	SOCKET BOLT 8X25	SOCKET BOLT 8X25	2	
96600-08035		96600-08035-06	SOCKET BOLT 8X35	SOCKET BOLT 8X35	4	
96700		96700-KED9-900	BOLT SOCKET 8*30	BOLT SOCKET 8*30	2	

Sales mark	Ref no	Part no	Description	Reg description	Regd no	F07
	39660	39660-LGC6-E00	SENSOR. TIRE PRESURE	SENSOR. TIRE PRESURE	1	
	44301	44301-LGC6-E00	AXLE FE WHEEL	AXLE FE WHEEL	1	
	44312	44312-LBA2-E00	COLLAR FR WHEEL SIDE L	COLLAR FR WHEEL SIDE L	2	
**	44600	44600-LGC6-305	WHEEL ASSY FR	WHEEL ASSY FR	1	
	44620	44620-LGC6-E00	COLLAR FR WHEEL DIST	COLLAR FR WHEEL DIST	1	
	44710	44710-AKB8-E00	TIRE ASSY FR 120/70 R15 M/C 56H	TIRE ASSY FR 120/70 R15 M/C 56H	1	
**	45100	45100-LGC6-E00	CALIPER ASSY FR L	CALIPER ASSY FR L	1	
	45105	45105-LGC6-305	PAD SET	PAD SET	2	
	45108	45108-LGC6-305	PAD SPRING SET	PAD SPRING SET	2	
	4512A	4512A-LGC6-E01	DISK ASSY FR BRAKE	DISK ASSY FR BRAKE	2	
**	45200	45200-LGC6-E00	CALIPER ASSY FR R	CALIPER ASSY FR R	1	
	45352	45352-LKF5-E00	TOOTHED RING. SENSOR	TOOTHED RING. SENSOR	1	
	50604	50604-LGC6-E00	BOLT GR AXLE	BOLT GR AXLE	1	
	90105	90105-KCR3-001	BOLT FR DISK 8*24	BOLT FR DISK 8*24	10	
	90122	90122-LKF5-E00	BOLT FLANGE 10X58	BOLT FLANGE 10*58	4	
	91257	91257-KED9-900	DUST SEAL 28*42*8	DUST SEAL 28*42*8	2	
	96052	96052-PRA1-E00	BOLT M5*16	BOLT M5*16	5	
	96150	96150-60040-10	BEARING BALL RADIAL 6004	BEARING BALL RADIAL 6004	2	

F08

Rear Wheel

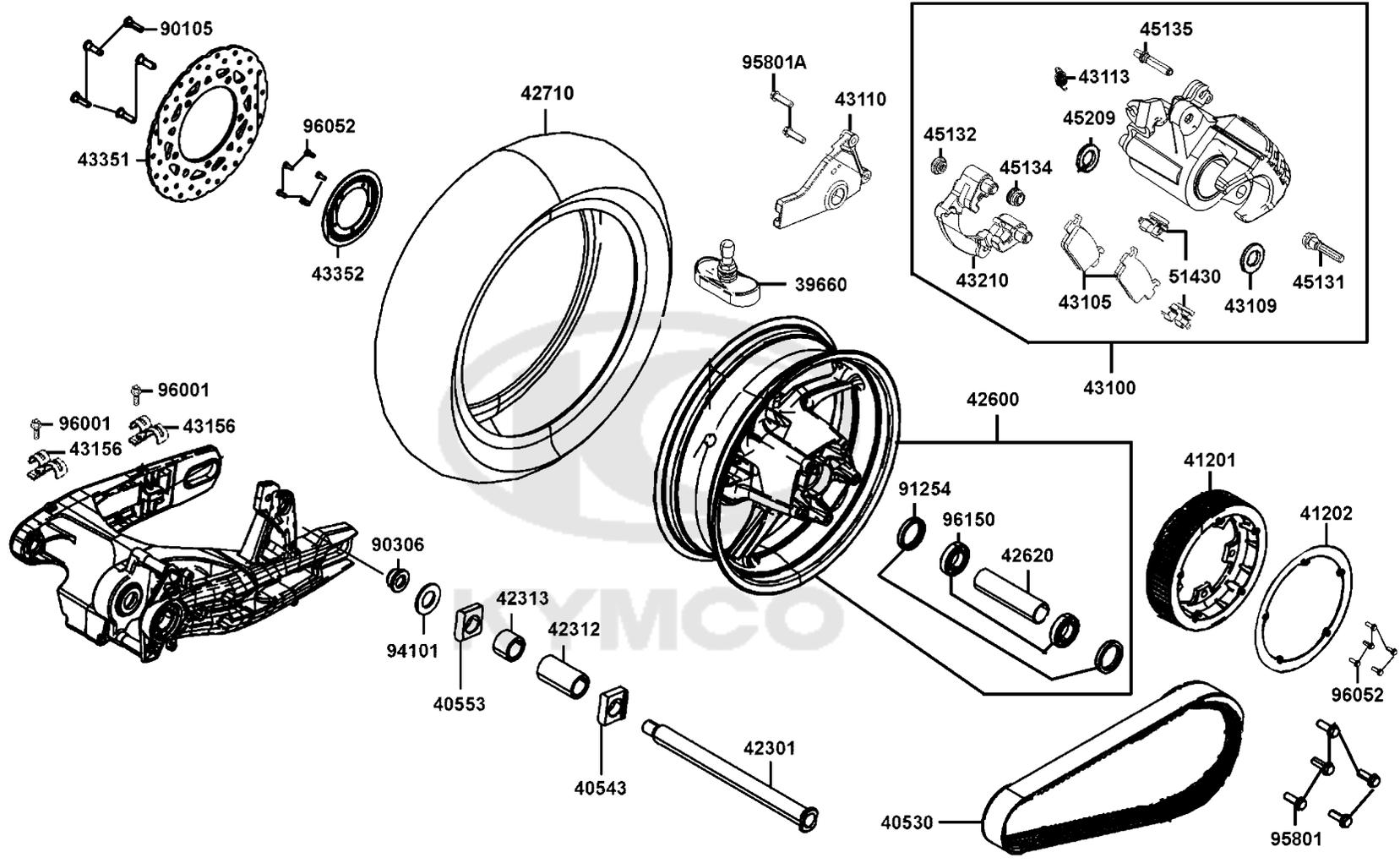

Sales mark	Ref no	Part no	Description	Reg description	Regd no	F08
	39660	39660-LGC6-E00	SENSOR. TIRE PRESURE	SENSOR. TIRE PRESURE	1	
	40530	40530-AGJ5-E00	TIMING BELT	TIMING BELT	1	
	40543	40543-LGC6-E00	ADJUSTER L/H BELT	ADJUSTER L/H BELT	1	
	40553	40553-LGC6-E00	ADJUSTER R/H BELT	ADJUSTER R/H BELT	1	
**	41201	41201-AGJ5-E00	SPROCKET DRIVEN	SPROCKET DRIVEN	1	
	41202	41202-LGC6-E00	PLATE FINAL DRIVE	PLATE FINAL DRIVE	1	
	42301	42301-LGC6-E00	AXLE RR WHEEL	AXLE RR WHEEL	1	
	42312	42312-LGC6-E00	COLLAR RR WHEEL SIDE A	COLLAR RR WHEEL SIDE A	1	
	42313	42313-AKB8-E00	COLLAR RR WHEEL SIDE B	COLLAR RR WHEEL SIDE B	1	
**	42600	42600-LGC6-305	WHEEL SET RR	WHEEL SET RR	1	
	42620	42620-LGC6-E00	COLLAR RR WHEEL DIST	COLLAR RR WHEEL DIST	1	
	42710	42710-AKB8-E00	TIRE ASSY RR 160/60R15 M/C 67H	TIRE ASSY RR 160/60R15 M/C 67H	1	
**	43100	43100-LGC6-E01	CALIPER ASSY RR	CALIPER ASSY RR	1	
	43105	43105-LGC6-305	PAD SET	PAD SET	1	
	43109	43109-LGC6-E00	DUST SEAL	DUST SEAL	1	
**	43110	43110-LGC6-E00	HOLDER, RR CALIPER	HOLDER, RR CALIPER	1	
	43113	43113-LBA2-E00	SPRING BRAKE ARM	SPRING BRAKE ARM	1	
	43156	43156-LGC6-E00	CLAMPER RR BRK HOSE	CLAMPER RR BRK HOSE	2	
**	43210	43210-LGC6-305	BRACKET ASSY RR	BRACKET ASSY RR	1	
	43351	43351-LGC6-E01	DISK RR BRAKE	DISK RR BRAKE	1	

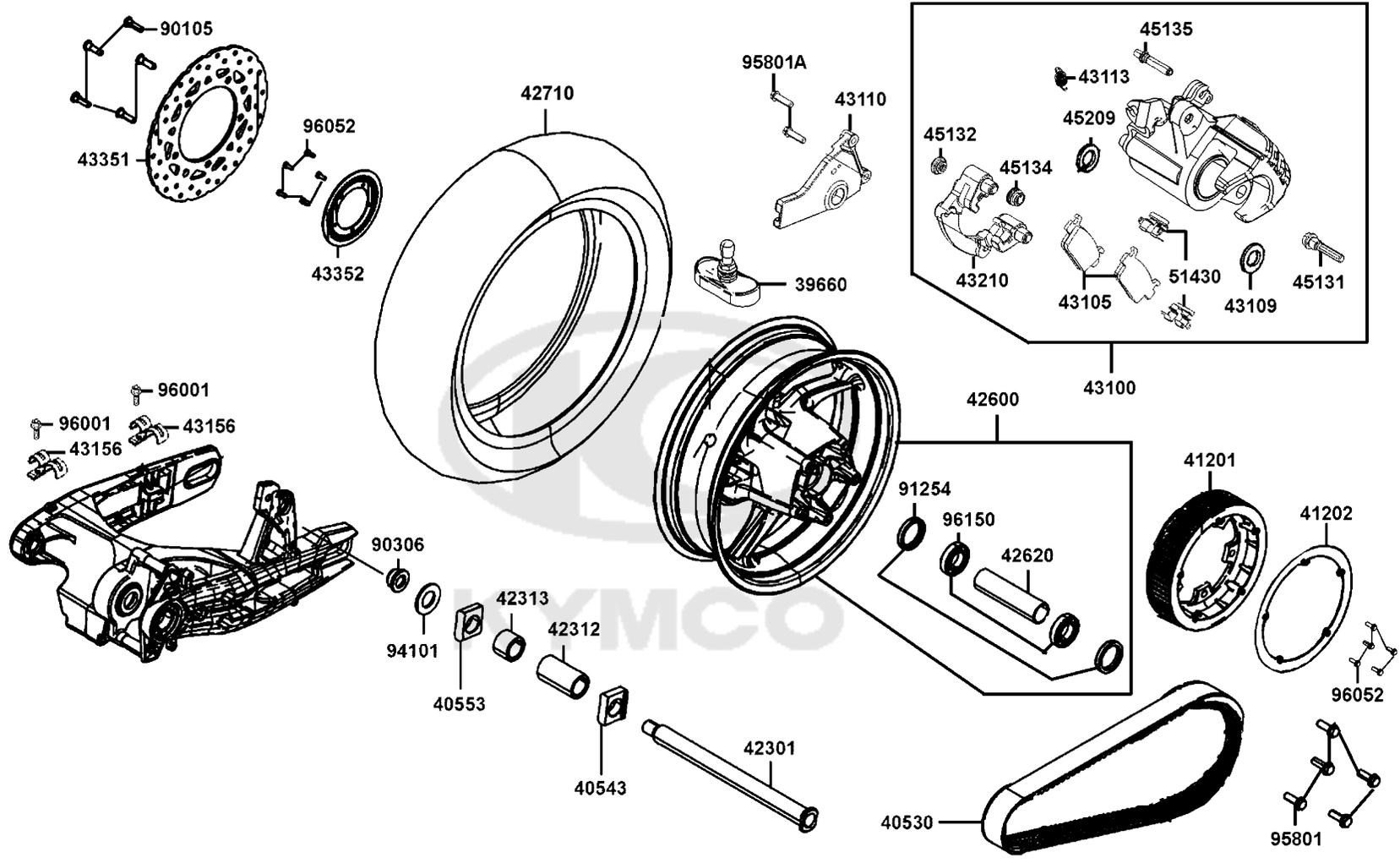

Sales mark	Ref no	Part no	Description	Reg description	Regd no	F08
	43352	43352-LGC6-E00	TOOTHED RING RR SENSOR	TOOTHED RING RR SENSOR	1	
	45131	45131-LDH1-E00	PIN BOLT	PIN BOLT	1	
	45132	45132-LDH1-E00	BUSH BOOT PIN	BUSH BOOT PIN	1	
	45134	45134-KED9-900	BOOT B	BOOT B	1	
	45135	45135-KED9-900	PIN BOLT A	PIN BOLT A	1	
	45209	45209-LGC6-E00	SEAL PISTON	SEAL PISTON	1	
	51430	51430-ACD5-E00	SPRING PAD	SPRING PAD	2	
	90105	90105-KCR3-001	BOLT FR DISK 8*24	BOLT FR DISK 8*24	5	
	90306	90306-LBA2-900	NUT U 20MM	NUT U 20MM	1	
	91254	91254-LGC6-E00	OIL SEAL 40X52X8	OIL SEAL 40X52X8	2	
	94101	94101-LGC6-E00	WASHER PLAIN 20.5X38X3(B)	WASHER PLAIN 20.5X38X3(B)	1	
	95801	95801-10030-06	BOLT FLANGE 10X30	BOLT FLANGE 10X30	5	
	95801A	95801-LEA1-900	BOLT FLANGE 10*35	BOLT FLANGE 10*35	2	
	96001	96001-06012-06	BOLT FLANGE SH 6*12	BOLT FLANGE SH 6*12	2	
	96052	96052-PRA1-E00	BOLT M5*16	BOLT M5*16	10	
	96150	96150-LGC6-E00	BRG. BALL RADIAL 60/28 LLU CGMU9V8	BRG. BALL RADIAL 60/28 LLU CGMU9V8	1	

Sales mark	Ref no	Part no	Description	Reg description	Regd no	F09
**	77200	77200-AKB8-309	SEAT ASSY	SEAT ASSY	1	
	77206	77206-KGBG-900	RUBBER SEAT CUSHION	RUBBER SEAT CUSHION	3	
	77210	77210-AKB8-E00	BACK SEAT ASSY	BACK SEAT ASSY	1	
	77300	77300-AKB8-E00	HINGE ASSY SEAT	HINGE ASSY SEAT	1	
	77303	77303-LHJ8-900	HOOK SEAT LOCK	HOOK SEAT LOCK	2	
	7731A	7731A-AKB8-E00	STAY ASSY DAMPER	STAY ASSY DAMPER	1	
	89010	89010-LGC6-E00	TOOL SET	TOOL SET	1	
	90101	90101-KGC4-E00	SCREW SPECIAL 6*15	SCREW SPECIAL 6*15	4	
	94050	94050-06060	NUT FLANGE 6MM	NUT FLANGE 6MM	2	
	94050A	94050-06080	NUT FLANGE 6MM	NUT FLANGE 6MM	3	
	95701	95701-08035-06	BOLT FLANGE 8*35	BOLT FLANGE 8*35	4	

F10

Fuel Tank

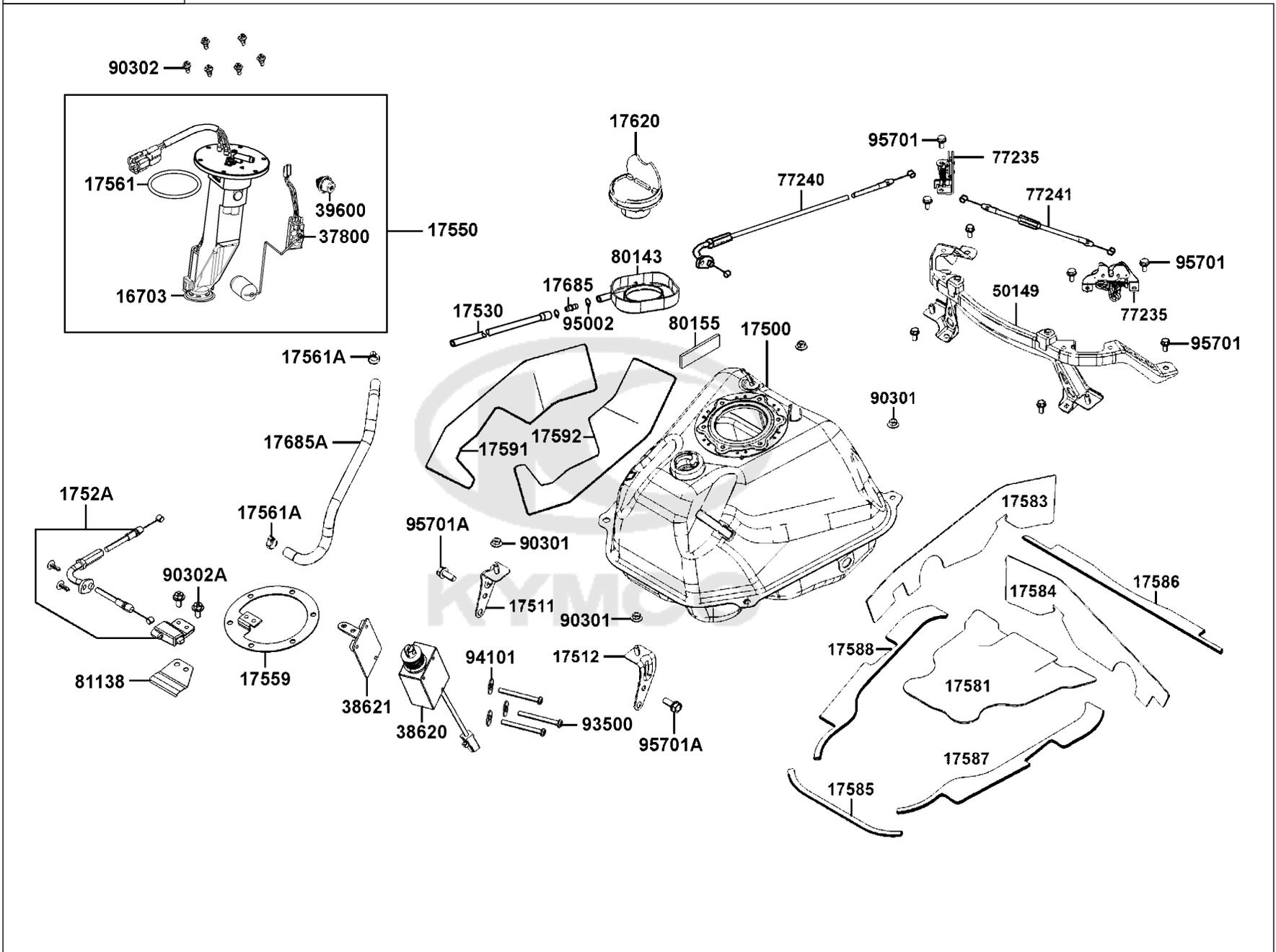

Sales mark	Ref no	Part no	Description	Reg description	Regd no	F10
	16703	16703-LHJ8-800	FUEL FILTER ASSY	FUEL FILTER ASSY	1	
	17500	17500-LGC6-E00	TANK COMP FUEL	TANK COMP FUEL	1	
	17511	17511-LGC6-E00	STAY R FUEL TANK	STAY R FUEL TANK	1	
	17512	17512-LGC6-E00	STAY L FUEL TANK	STAY L FUEL TANK	1	
	1752A	1752A-AKB8-E00	CABLE ASSY FUEL CAP	CABLE ASSY FUEL CAP	1	
	17530	17530-KGB5-900	TUBE ASSY DRAIN	TUBE ASSY DRAIN	1	
	17550	17550-AKB8-E00	PUMP ASSY FUEL	PUMP ASSY FUEL	1	
	17559	17559-LGC6-E00	STAY FUEL CAP CATCH	STAY FUEL CAP CATCH	1	
#	17561	17561-LGC6-E00	O RING	O RING	1	
	17561A	17561-LKB9-900	CLIP 12.5	CLIP 12.5	2	
	17581	17581-LGC6-E00	HEAT GUARD FUEL TANK BOTTOM	HEAT GUARD FUEL TANK BOTTOM	1	
	17583	17583-LGC6-E00	HEAT GUARD FUEL TANK R	HEAT GUARD FUEL TANK R	1	
	17584	17584-LGC6-E00	HEAT GUARD FUEL TANK L	HEAT GUARD FUEL TANK L	1	
	17585	17585-LGC6-E00	HEAT GUARD D FUEL TANK SIDE	HEAT GUARD D FUEL TANK SIDE	1	
	17586	17586-LGC6-E00	HEAT GUARD A FUEL TANK SIDE	HEAT GUARD A FUEL TANK SIDE	1	
	17587	17587-LGC6-E00	HEAT GUARD B FUEL TANK SIDE	HEAT GUARD B FUEL TANK SIDE	1	
	17588	17588-LGC6-E00	HEAT GUARD C FUEL TANK SIDE	HEAT GUARD C FUEL TANK SIDE	1	
	17591	17591-LGC6-E00	HEAT GUARD R FUEL TANK TOPPER	HEAT GUARD RFUEL TANK TOPPER	1	
	17592	17592-LGC6-E00	HEAT GUARD L FUEL TANK TOPPER	HEAT GUARD LFUEL TANK TOPPER	1	
	17620	17620-LGC6-E00	CAP COMP FUEL FILLER	CAP COMP FUEL FILLER	1	

F10

Fuel Tank

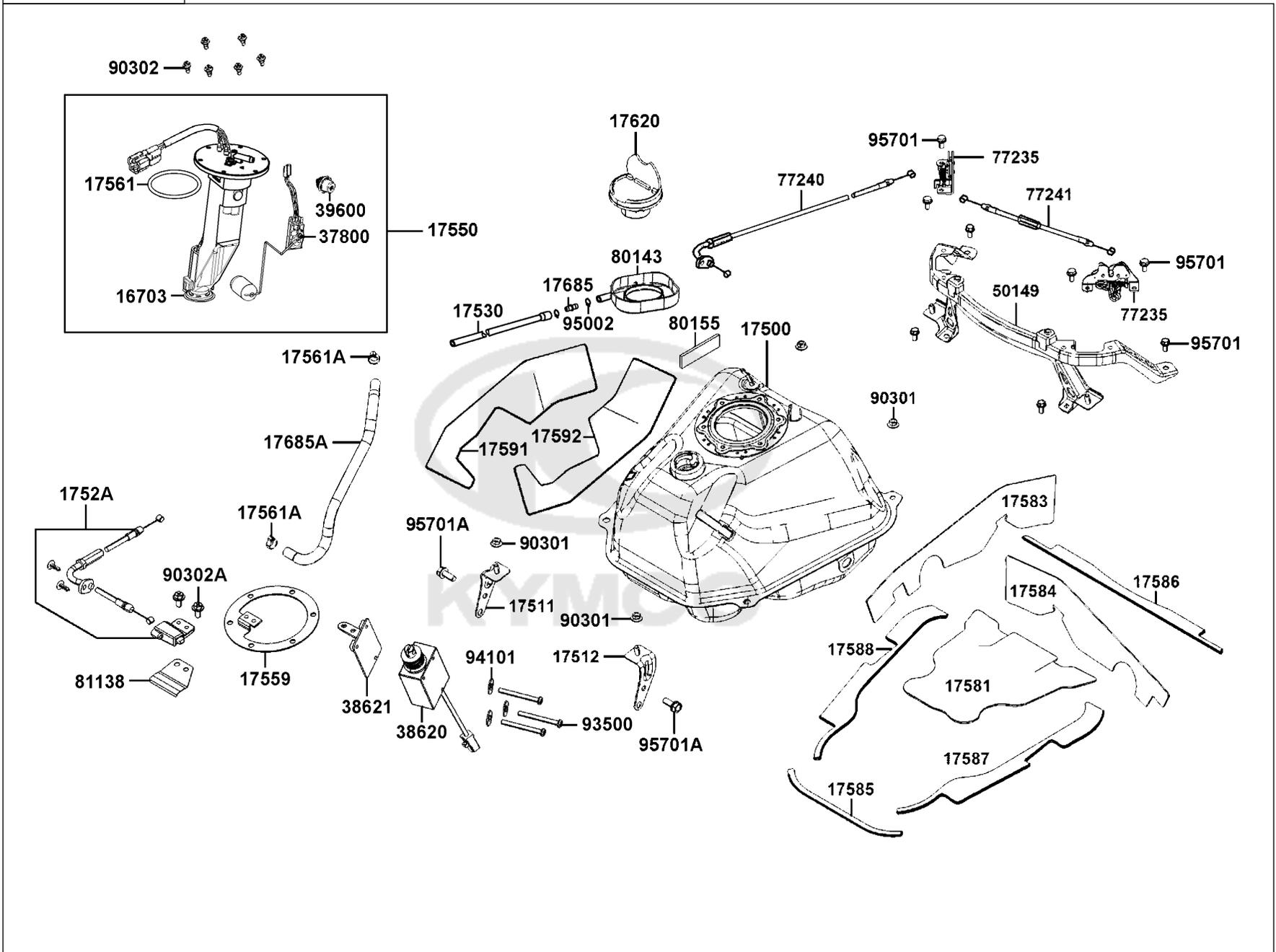

Sales mark	Ref no	Part no	Description	Reg description	Regd no	F10
	17685	17685-KZCZ-900	JOINT TUBE	JOINT TUBE	1	
	17685A	17685-LGC6-E00	TUBE FUEL PUMP	TUBE FUEL PUMP	1	
	37800	37800-AKB8-E00	FUEL UNIT	FUEL UNIT	1	
	38620	38620-LGC6-E00	LINEAR MOTOR ASS'Y	LINEAR MOTOR ASS'Y	1	
	38621	38621-LGC6-E00	STAY LINEAR MOTOR	STAY LINEAR MOTOR	1	
	39600	39600-ACH6-900	REGULATOR FUEL	REGULATOR FUEL	1	
	50149	50149-LGC6-E00	STAY SEAT CATCH	STAY SEAT CATCH	1	
	77235	77235-LGC6-E00	CATCH COMP SEAT	CATCH COMP.SEAT	2	
	77240	77240-AKB8-E00	CABLE SEAT LOCK	CABLE SEAT LOCK	1	
	77241	77241-LGC6-E00	CABLE COMP SEAT CATCH	CABLE COMP. SEAT CATCH	1	
	80143	80143-LGC6-E00	RUBBER FUEL CAP	RUBBER FUEL CAP	1	
#	80155	80155-AKB8-E00	SPONGE B LID FUEL CAP	SPONGE B LID FUEL CAP	2	
	81138	81138-LGC6-E00	SET LOCK	SET LOCK	1	
	90301	90301-6D34-671	NUT FLANGE 6MM	NUT FLANGE 6MM	4	
	90302	90302-GFY6-940	BOLT-WASH 5*16	BOLT-WASH 5*16	6	
	90302A	90302-LLB1-E00	BOLT-WASHER 5*12	BOLT-WASHER 5*12	2	
	93500	93500-LGC6-E00	SCREW PAN 4X40	SCREW PAN 4X40	3	
	94101	94101-04800	WASHER PLAIN 4.5*10*0.8	WASHER PLAIN 4.5*10*0.8	3	
	95002	95002-02080	CLIP B8 TUBE	CLIP B8 TUBE	1	
	95701	95701-06012-06	BOLT FLANGE 6X12	BOLT FLANGE 6X12	8	

F10

Fuel Tank

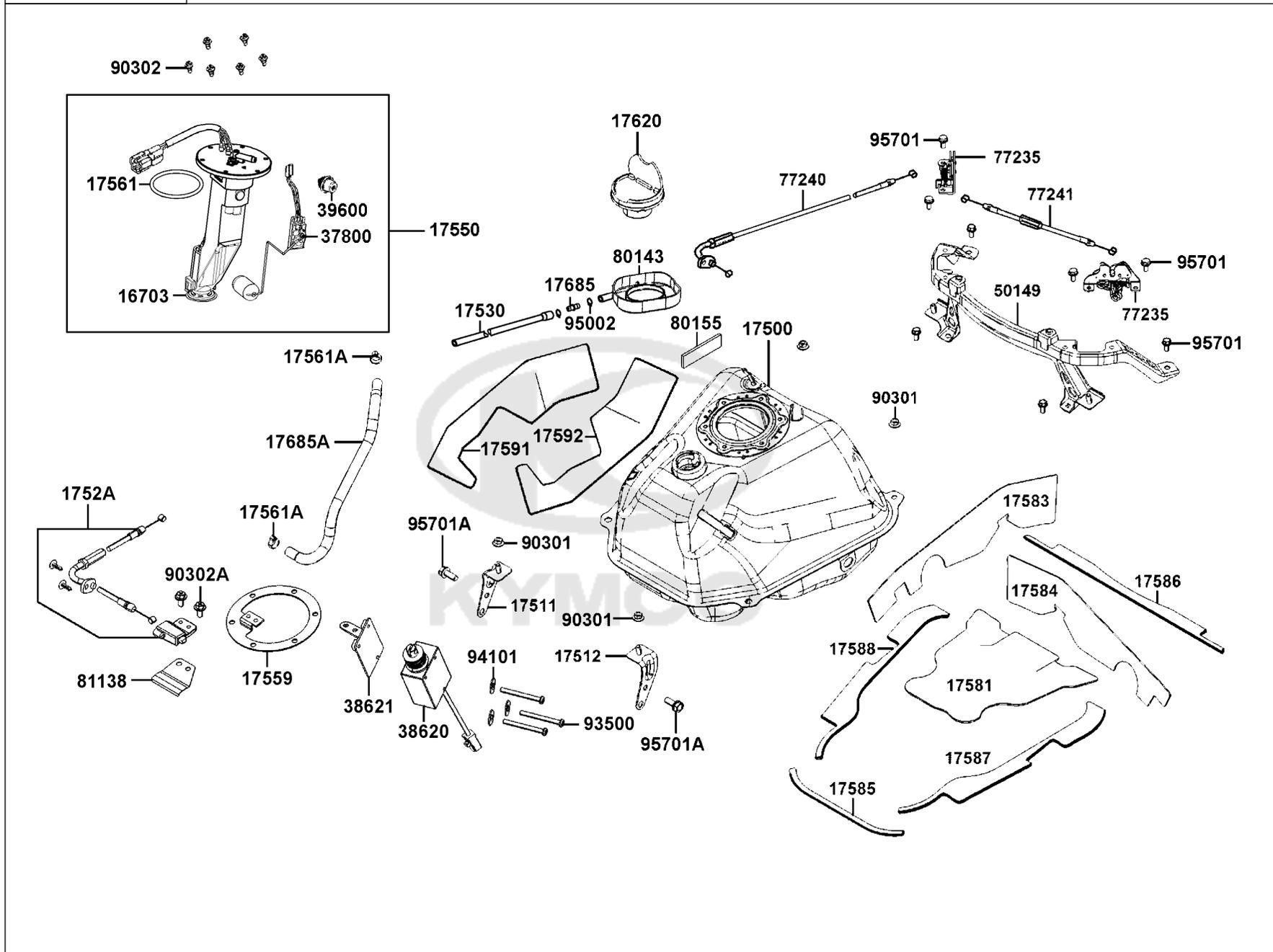

Sales mark	Ref no	Part no	Description	Reg description	Regd no	F10
------------	--------	---------	-------------	-----------------	---------	------------

95701A

95701-08016-06

BOLT FLANGE 8*16

BOLT FLANGE 8*16

2



F11

Battery

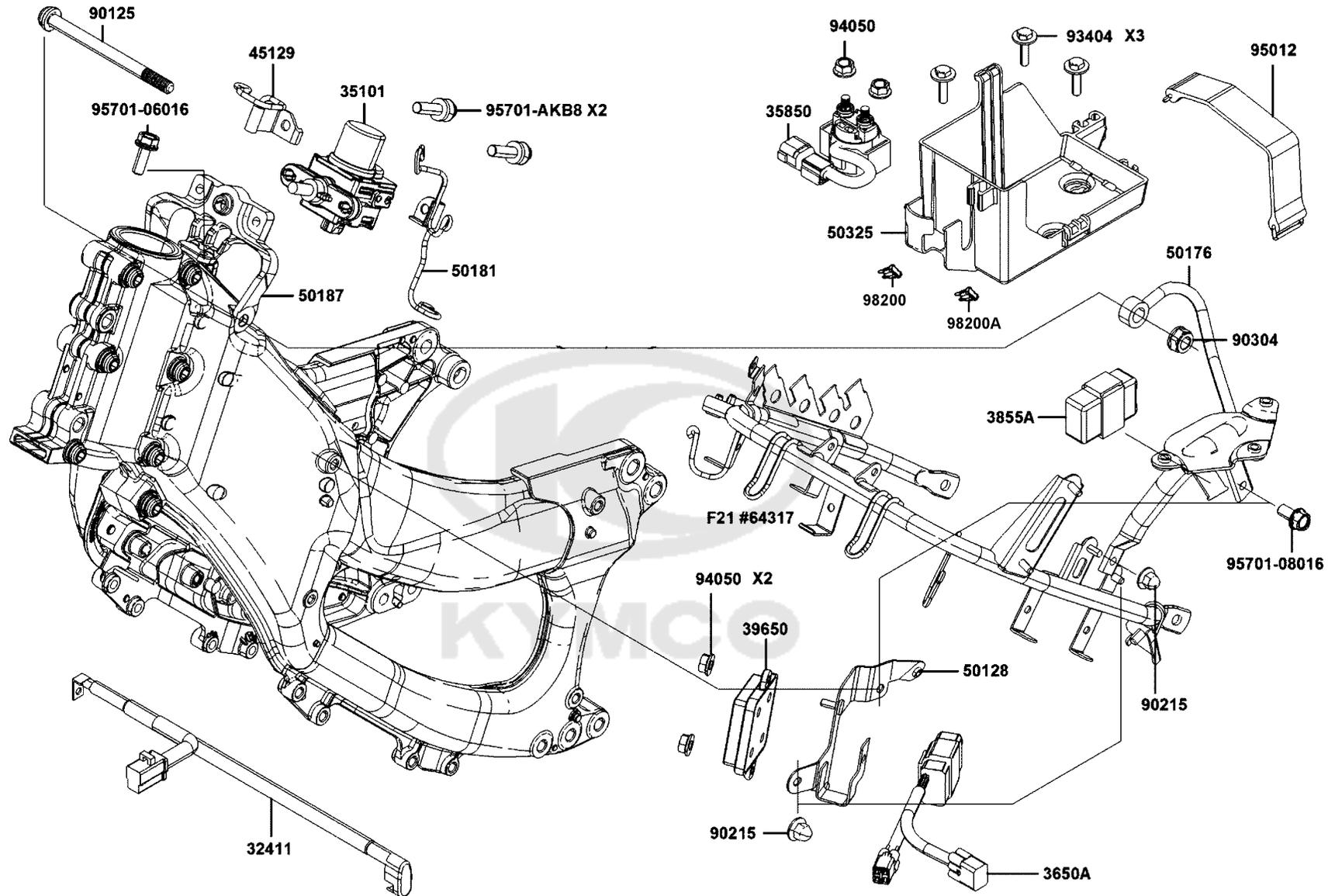

Sales mark	Ref no	Part no	Description	Reg description	Regd no	F11
	32411	32411-AKB8-E00	CABLE BAT	CABLE BAT	1	
	35101	35101-AKB8-E00	SW COMB LOCK	SW COMB LOCK	1	
	35850	35850-KHB4-90A	SET START MAG (D402)	SET START MAG (D402)	1	
	3650A	3650A-LGC6-E00	DRIVER ASS Y HEATED GRIP	DRIVER ASS Y HEATED GRIP	1	
	3855A	3855A-AKB8-E00	RELAY ASSY ELECTRIC ADJUSTED	RELAY ASSY ELECTRIC ADJUSTED VISOR	1	
	39650	39650-LGC6-E00	CONTROL UNIT. TIRE PRESURE	CONTROL UNIT. TIRE PRESURE	1	
	45129	45129-AKB8-E00	CLIP BRK CABLE	CLIP BRK CABLE	1	
	50128	50128-AKB8-E01	STAY,TIRE PRESSURE CONTROLLER	STAY,TIRE PRESSURE CONTROLLER	1	
	50176	50176-AKB8-E00	STAY BETTERY	STAY BETTERY	1	
	50181	50181-AKB8-E00	CLIP THROD CABLE	CLIP THROD CABLE	1	
	50187	50187-AKB8-E00	STAY MAIN SW	STAY MAIN SW	1	
**	50325	50325-AKB8-E01	CASE BATTERY (Black)	CASE BATTERY (Black)	1	
	90125	90125-AKB8-E00	BOLT FLANGE 10X140	BOLT FLANGE 10X140	1	
	90215	90215-KKC4-900	NUT CAP 6MM	NUT CAP 6MM	2	
	90304	90304-LEA1-900	NUT U FLANGE 10MM	NUT U FLANGE 10MM	1	
	93404	93404-06012-06	BOLT WASHER 6X12	BOLT WASHER 6X12	3	
	94050	94050-06060	NUT FLANGE 6MM	NUT FLANGE 6MM	4	
	95012	95012-KED9-900	BAND BATTERY	BAND BATTERY	1	
	95701-06016	95701-06016-06	BOLT FLANGE 6X16	BOLT FLANGE 6X16	1	
	95701-08016	95701-08016-06	BOLT FLANGE 8*16	BOLT FLANGE 8*16	1	

F11

Battery

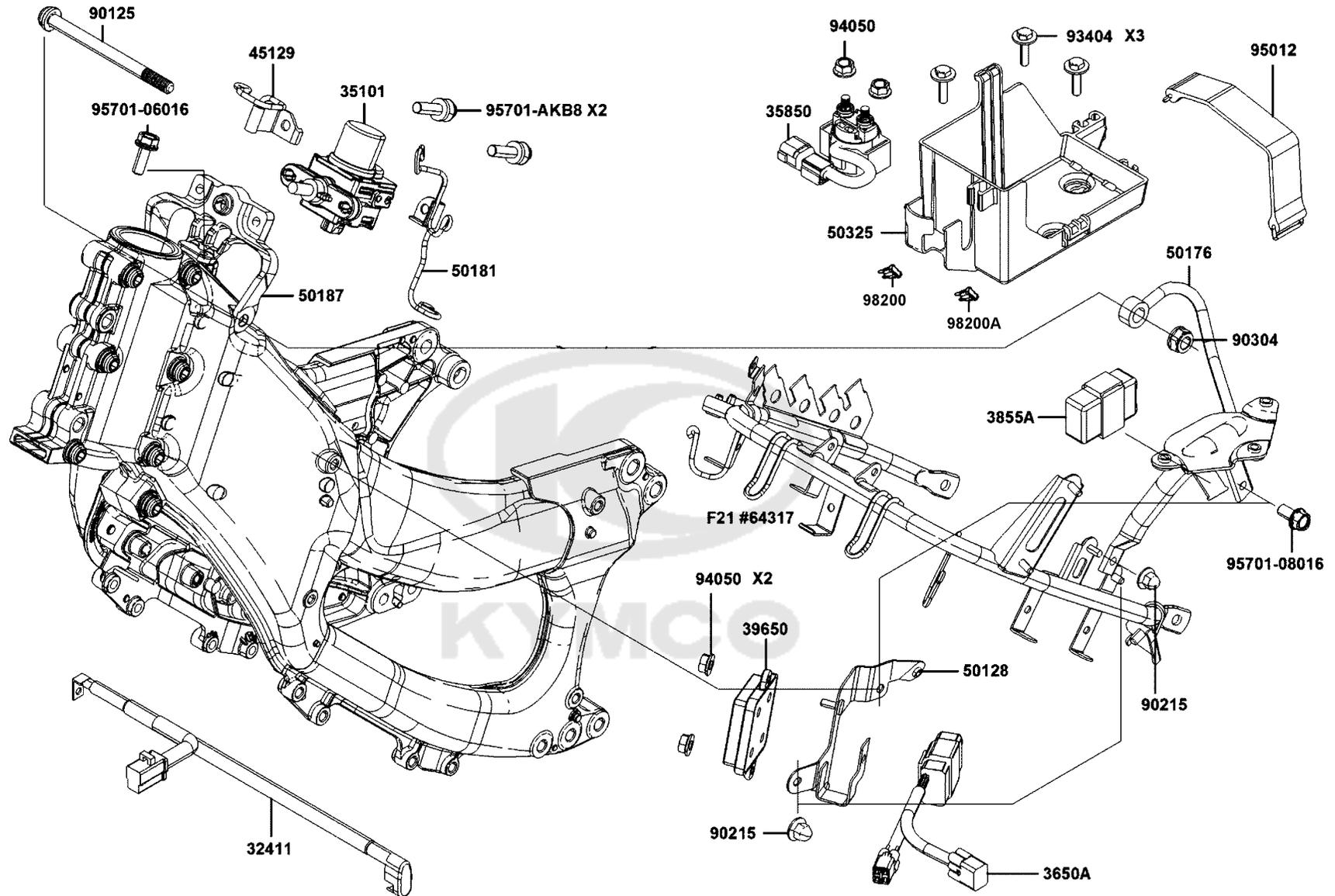

Sales mark	Ref no	Part no	Description	Reg description	Regd no	F11
------------	--------	---------	-------------	-----------------	---------	-----

95701-AKB8		95701-AKB8-E00	BOLT TORQUE 8X25	BOLT TORQUE 8X25	2	
98200		98200-40500	FUSE 5A (MINI)	FUSE 5A (MINI)	1	
98200A		98200-40750	BLADE FUSE MINI 7.5A	BLADE FUSE MINI 7.5A	1	



F12

ECU ASSY

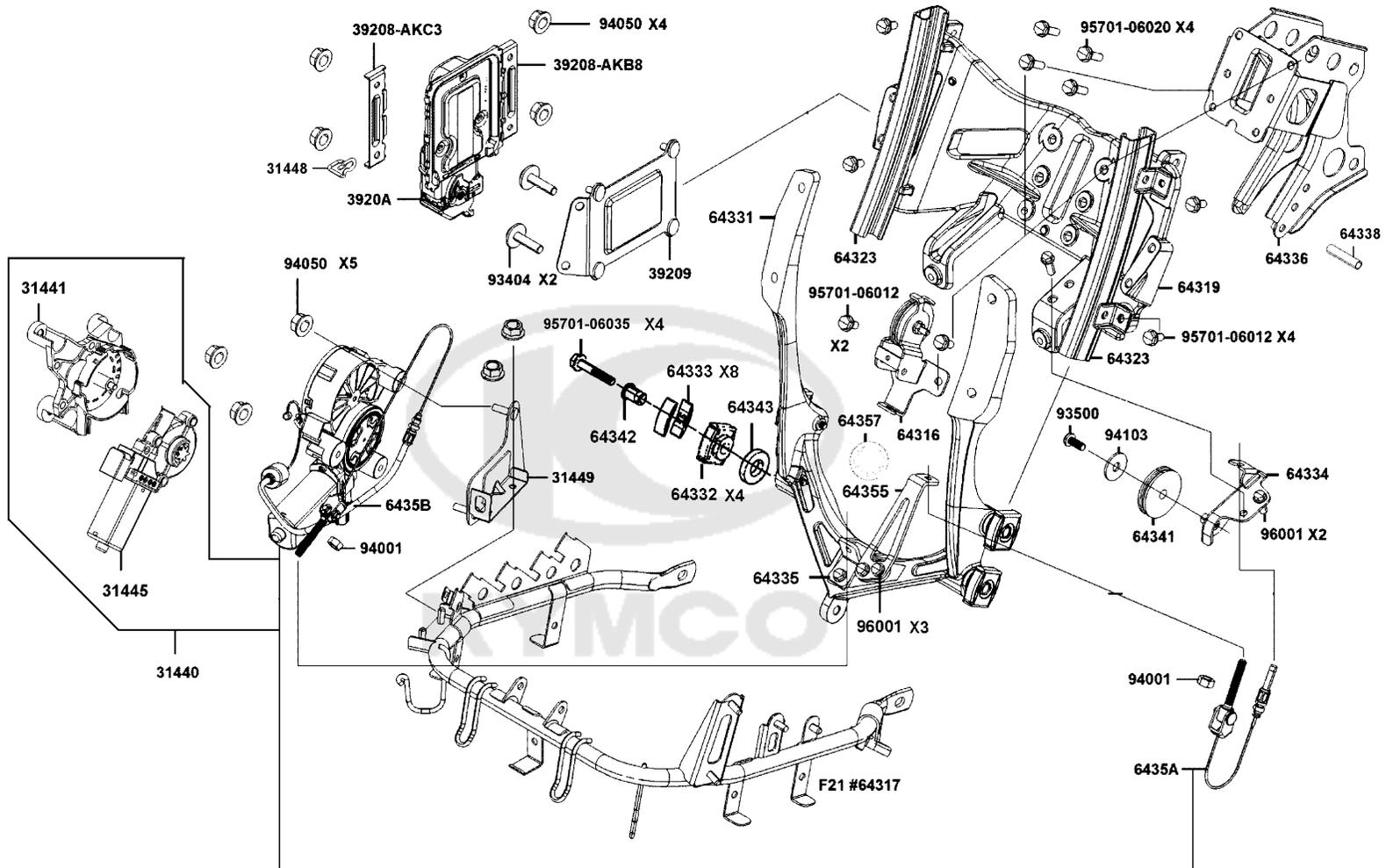

Sales mark	Ref no	Part no	Description	Reg description	Regd no	F12
	31440	31440-AKB8-E00	MOTOR ASSY ELECTRIC ADJUSTED	MOTOR ASSY ELECTRIC ADJUSTED VISOR	1	
	31441	31441-AKB8-E00	WIRE WHEEL BOX	WIRE WHEEL BOX	1	
	31445	31445-AKB8-E00	MOTOR UNIT	MOTOR UNIT	1	
	31448	31448-AKB8-E00	CLIP SLIDING BRKT CABLE	CLIP SLIDING BRKT CABLE	1	
	31449	31449-AKB8-E00	STAY ELECTRIC VISOR MOTOR	STAY ELECTRIC VISOR MOTOR	1	
	39208-AKB8	39208-AKB8-E01	HOLDER M4C ECU	HOLDER M4C ECU	1	
	39208-AKC3	39208-AKC3-EZ5	HOLDER M4C ECU	HOLDER M4C ECU	1	
	39209	39209-AKB8-E00	STAY ECU	STAY ECU	1	
	3920A	3920A-AKB8-E00	ECU ASSY	ECU ASSY	1	
	64316	64316-AKB8-E00	SLIDING SPRING VISOR ASSY	SLIDING SPRING VISOR ASSY	1	
	64319	64319-AKB8-E00	BRKT FR COVER	BRKT FR COVER	1	
	64323	64323-AKB8-E00	TRACK R SLIDING BRKT	TRACK R SLIDING BRKT	2	
	64331	64331-AKB8-E00	BRKT CROSS	BRKT CROSS	1	
	64332	64332-AKB8-E00	SLIDIER	SLIDIER	4	
	64333	64333-AKB8-E00	DAMPING SLIDER	DAMPING SLIDER	8	
	64334	64334-AKB8-E00	STAY CABLE ASSY	STAY CABLE ASSY	1	
	64335	64335-AKB8-E00	STAY CABLE	STAY CABLE	1	
	64336	64336-AKB8-E00	BRKT AUTO VISOR	BRKT AUTO VISOR	1	
	64338	64338-AKB8-E00	COLLAR. AUTO VISOR BRKT	COLLAR. AUTO VISOR BRKT	1	
	64341	64341-AKB8-E00	PULLEY CABLE	PULLEY CABLE	1	

Sales mark	Ref no	Part no	Description	Reg description	Regd no	F12
64342		64342-AKB8-E00	COLLAR	COLLAR	4	
64343		64343-AKB8-E00	COLLAR	COLLAR	4	
64355		64355-AKB8-E00	ARM CABLE FIXED	ARM CABLE FIXED	1	
64357		64357-AKB8-E00	COLLAR C	COLLAR C	1	
6435A		6435A-AKB8-E00	CABLE ASSY SLIDING BRKT	CABLE ASSY SLIDING BRKT	1	
6435B		6435B-AKB8-E00	CABLE ASSY B SLIDING BRKT	CABLE ASSY B SLIDING BRKT	1	
93404		93404-06012-06	BOLT WASHER 6X12	BOLT WASHER 6X12	2	
93500		93500-05012-0HG	SCREW PAN 5*12	SCREW PAN 5*12	1	
94001		94001-06080-0SG	NUT HEX 6MM	NUT HEX 6MM	2	
94050		94050-06060	NUT FLANGE 6MM	NUT FLANGE 6MM	9	
94103		94103-06600	WASHER PLAIN 6MM	WASHER PLAIN 6MM	1	
95701-06012		95701-06012-06	BOLT FLANGE 6X12	BOLT FLANGE 6X12	6	
95701-06020		95701-06020-06	BOLT FLANGE 6*20	BOLT FLANGE 6*20	4	
95701-06035		95701-06035-08G	BOLT FLANGE 6*35	BOLT FLANGE 6*35	4	
96001		96001-06016-08G	BOLT FLANGE SH 6x16 (C)	BOLT FLANGE SH 6*16 (CR3+)	4	

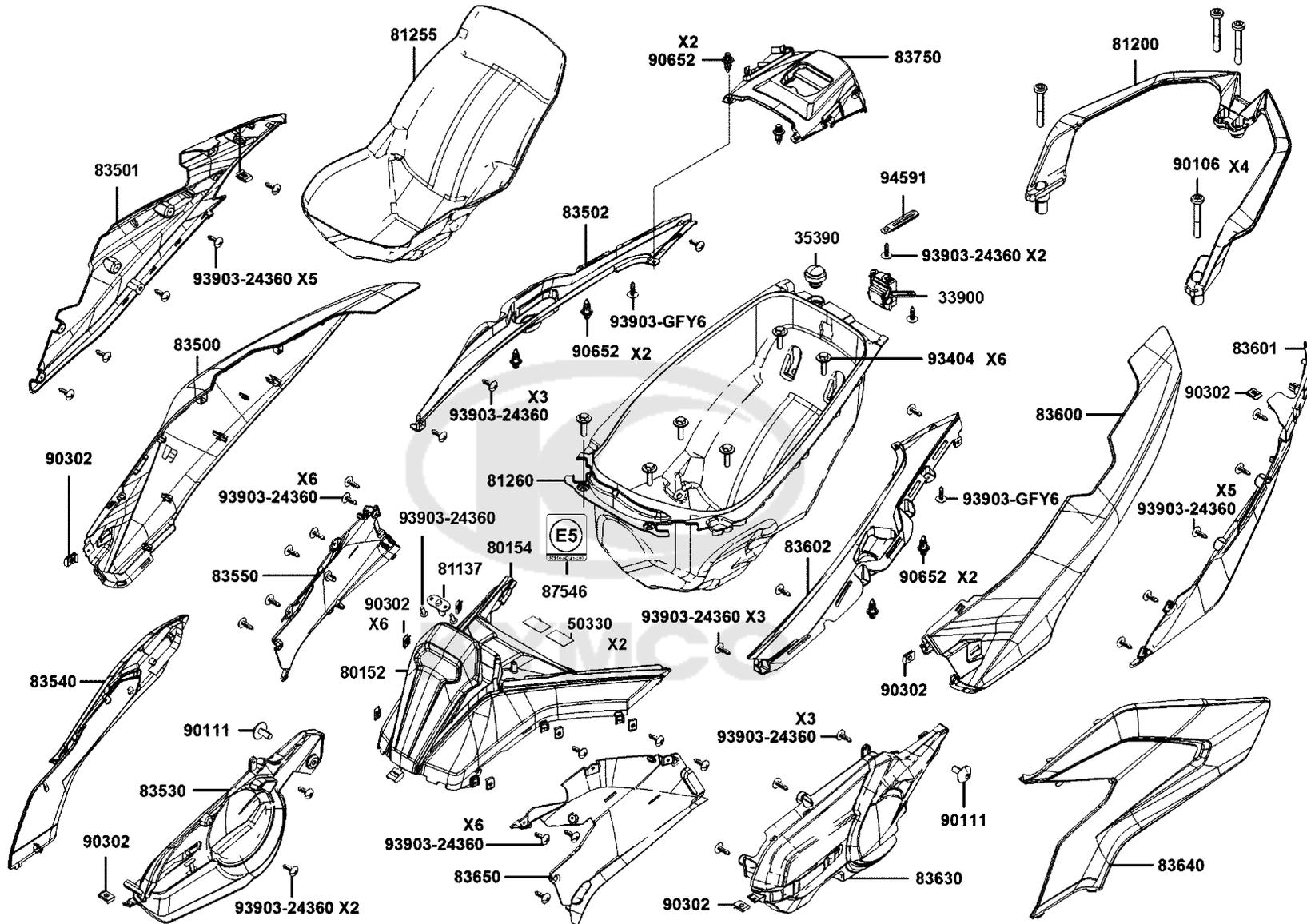

Sales mark	Ref no	Part no	Description	Reg description	Regd no	F13
	33900	33900-LGC6-E00	LIGHT ASSY LUGGAGE BOX	LIGHT ASSY.. LUGGAGE BOX	1	
	35390	35390-LHG7-E00	SENSOR LUGGAGE BOX LIGHT	SENSOR LUGGAGE BOX LIGHT	1	
	50330	50330-ALK5-900	PONGE BATTERY	PONGE BATTERY	2	
**	80152	80152-AKB8-E00	LIDFUEL CAP MAINT	LIDFUEL CAP MAINT	1	
**	80154	80154-AKB8-E00	COVER FUEL	COVER FUEL	1	
	81137	81137-LGC6-E00	HOOK FUEL COVER	HOOK FUEL COVER	1	
**	81200	81200-AKB8-E00	GRIP COMP RR	GRIP COMP RR	1	
	81255	81255-LGC6-E00	PAD LUGGAGE	PAD LUGGAGE	1	
	81260	81260-AKB8-E00	BOX LUGGAGE	BOX LUGGAGE	1	
**	83500	83500-AKB8-E00	COVER R BODY	COVER R BODY	1	
**	83501	83501-AKB8-E00	COVER B R BODY	COVER B R BODY	1	
**	83502	83502-AKB8-E00	COVER CR BODY	COVER CR BODY	1	
**	83530	83530-AKB8-E00	COVER A R SIDE	COVER A R SIDE	1	
**	83540	83540-AKB8-E00	BOARD C R SIDE	BOARD C R SIDE	1	
**	83550	83550-AKB8-E00	COVER C R SID	COVER C R SID	1	
**	83600	83600-AKB8-E00	COVER A L BODY	COVER A L BODY	1	
**	83601	83601-AKB8-E00	COVER B ASSY L BODY	COVER B ASSY L BODY	1	
**	83602	83602-AKB8-E00	COVER C L BODY	COVER C L BODY	1	
**	83630	83630-AKB8-E00	COVER A L SIDE	COVER A L SIDE	1	
**	83640	83640-AKB8-E00	BOARD C L SIDE	BOARD C L SIDE	1	

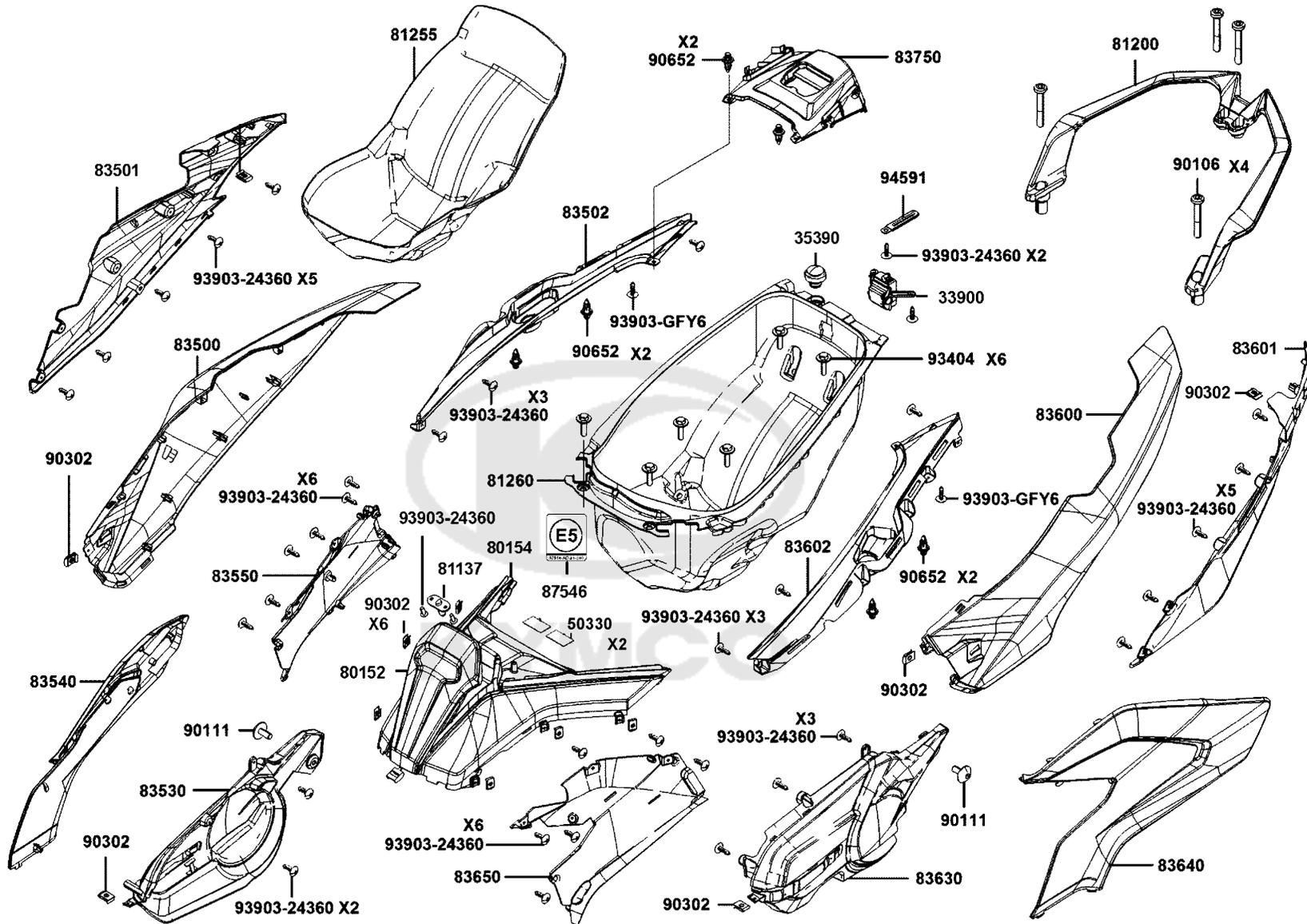

Sales mark	Ref no	Part no	Description	Reg description	Regd no	F13
**	83650	83650-AKB8-E00	COVER C L SIDE	COVER C L SIDE	1	
**	83750	83750-AKB8-E00	COVER RR CENTER	COVER RR CENTER	1	
**	87546	87546-ADG5-E00	LABEL FUEL TANK	LABEL FUEL TANK	1	
	90106	90106-LEC8-900	BOLT SPECIAL M8	BOLT SPECIAL M8	4	
	90111	90111-LGC6-E01	SCREW PAN 6X14	SCREW PAN 6X14	2	
	90302	90302-SDA4-004	NUT SPRING 4MM	NUT SPRING 4MM	6	
	90652	90652-LFB5-900	CLIP MUDGUARD	CLIP MUDGUARD	1	
	93404	93404-06012-06	BOLT WASHER 6X12	BOLT WASHER 6X12	6	
	93903-24360	93903-24360	SCREW TAPPING 4*12	SCREW TAPPING 4*12	2	
	93903-GFY6	93903-GFY6-900	SCREW TAPPING 4*14	SCREW TAPPING 4*14	2	
	94591	94591-27000	CLIP 2*70	CLIP 2*70	1	

F14

Air Cleaner

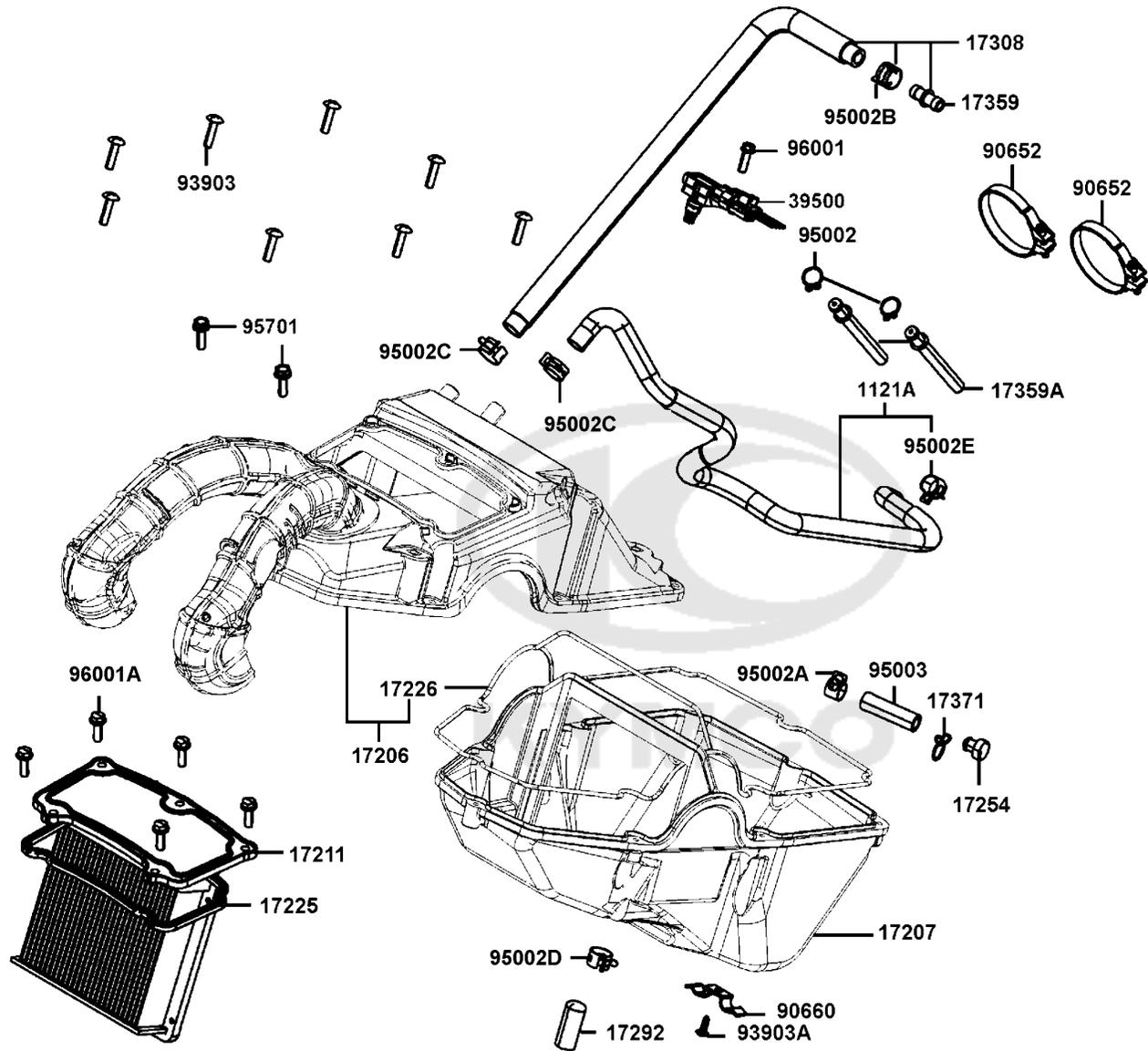

Sales mark	Ref no	Part no	Description	Reg description	Regd no	F14
1121A		1121A-LGC6-E00	TUBE ASSY BREATHER	TUBE ASSY BREATHER	1	
17206		17206-LGC6-305	CASE. AIR/C	CASE. AIR/C	1	
17207		17207-AKB8-E00	COVER. AIR/C	COVER. AIR/C	1	
17211		17211-LGC6-E00	ELEMENT COMP AIR/C	ELEMENT COMP AIR/C	1	
17225		17225-LGC6-E00	SEAL. AIR/C COVER	SEAL. AIR/C COVER	1	
17226		17226-LGC6-E00	SEAL. AIR/C CASE	SEAL. AIR/C CASE	1	
17254		17254-KACA-P00	PLUG AIR/C CONN TUBE	PLUG AIR/C CONN TUBE	1	
17292		17292-PWB1-900	PIPE DRAIN	PIPE DRAIN	1	
17308		17308-LGC6-E00	TUBE ASSY AIR/C	TUBE ASSY AIR/C	1	
17359		17359-4K19-671	JOINT BREATHER TUBE	JOINT BREATHER TUBE	1	
17359A		17359-LGC6-E00	JOINT. PURGE TUBE	JOINT. PURGE TUBE	2	
17371		17371-1D74-671	CLIP BREATHER TUBE	CLIP BREATHER TUBE	1	
39500		39500-AAC9-900	SENSOR T-MAP	SENSOR T-MAP	1	
90652		90652-KHE7-900	BAND CONNECTING TUBE	BAND CONNECTING TUBE	2	
90660		90660-LGC6-E00	CLAMP TUBE	CLAMP TUBE	1	
93903		93903-25460	SCREW TAPPING 5*20	SCREW TAPPING 5*20	8	
93903A		93903-34360	SCREW TAPPING 4X12	SCREW TAPPING 4X12	1	
95002		95002-02110	CLIP	CLIP	2	
95002A		95002-41100-08	CLIP D 11.0 TUBE	CLIP D 11.0 TUBE	1	
95002B		95002-41250-00	CLIP D12.5 TUBE	CLIP D12.5 TUBE	1	

F14

Air Cleaner

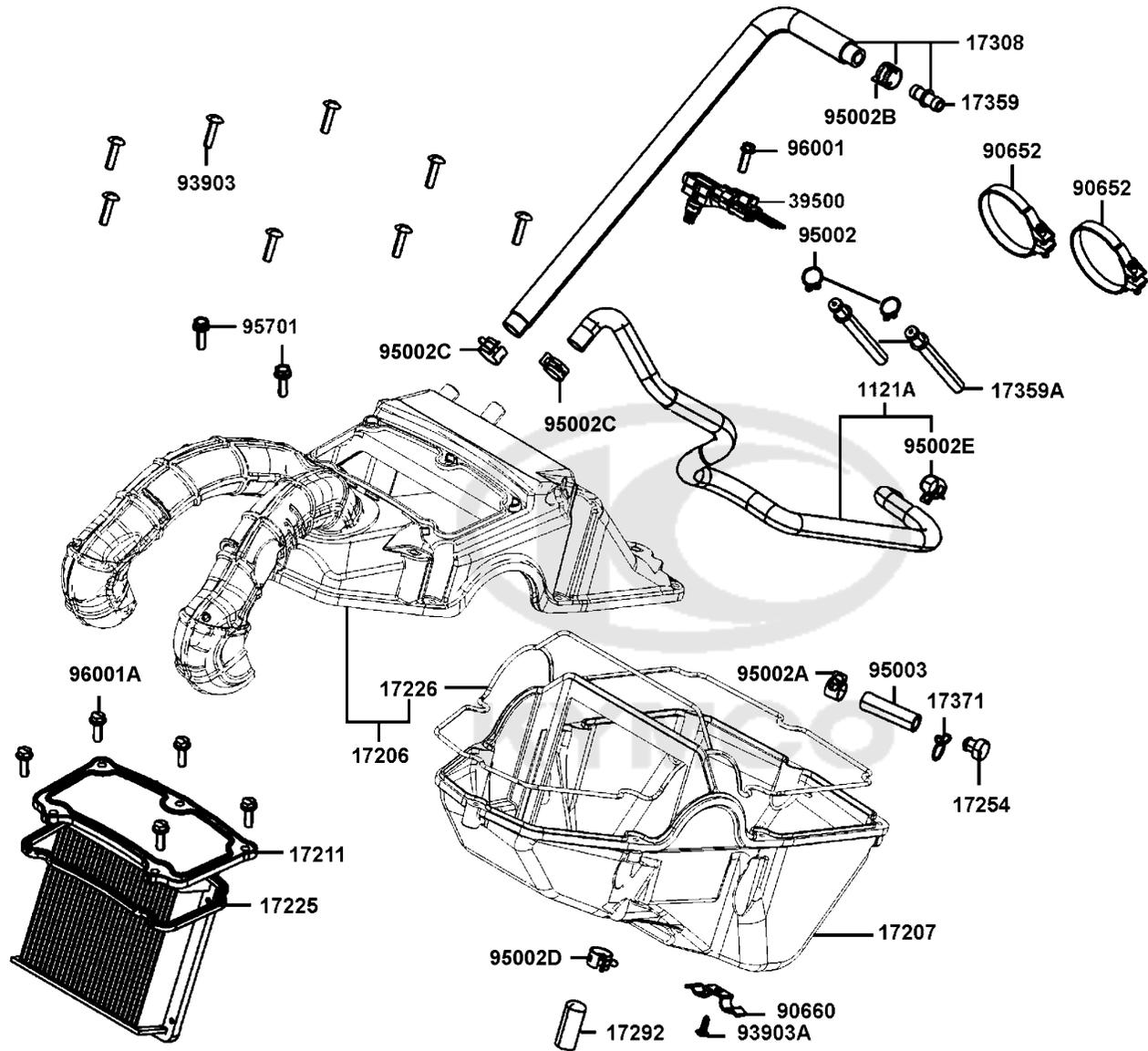

Sales mark	Ref no	Part no	Description	Reg description	Regd no	F14
95002C		95002-KED9-M30	CLAMP D14.8 TUBE	CLAMP D14.8 TUBE	1	
95002D		95002-LHG8-E00	CLAMP.D14 TUBE	CLAMP.D14 TUBE	1	
95002E		95002-LKF5-E00	CLAMP D14.6 TUBE	CLAMP D14.6 TUBE	1	
95003		95003-23004-60	V TUBE 8*12*40	V TUBE 8*12*40	1	
95701		95701-06020-06	BOLT FLANGE 6*20	BOLT FLANGE 6*20	2	
96001		96001-06018-06	BOLT FLANGE SH 6X18	BOLT FLANGE SH 6X18	1	
96001A		96001-LAB4-900	BOLT SPECIAL M5X16	BOLT SPECIAL M5X16	5	



F15

Exhaust Muffler

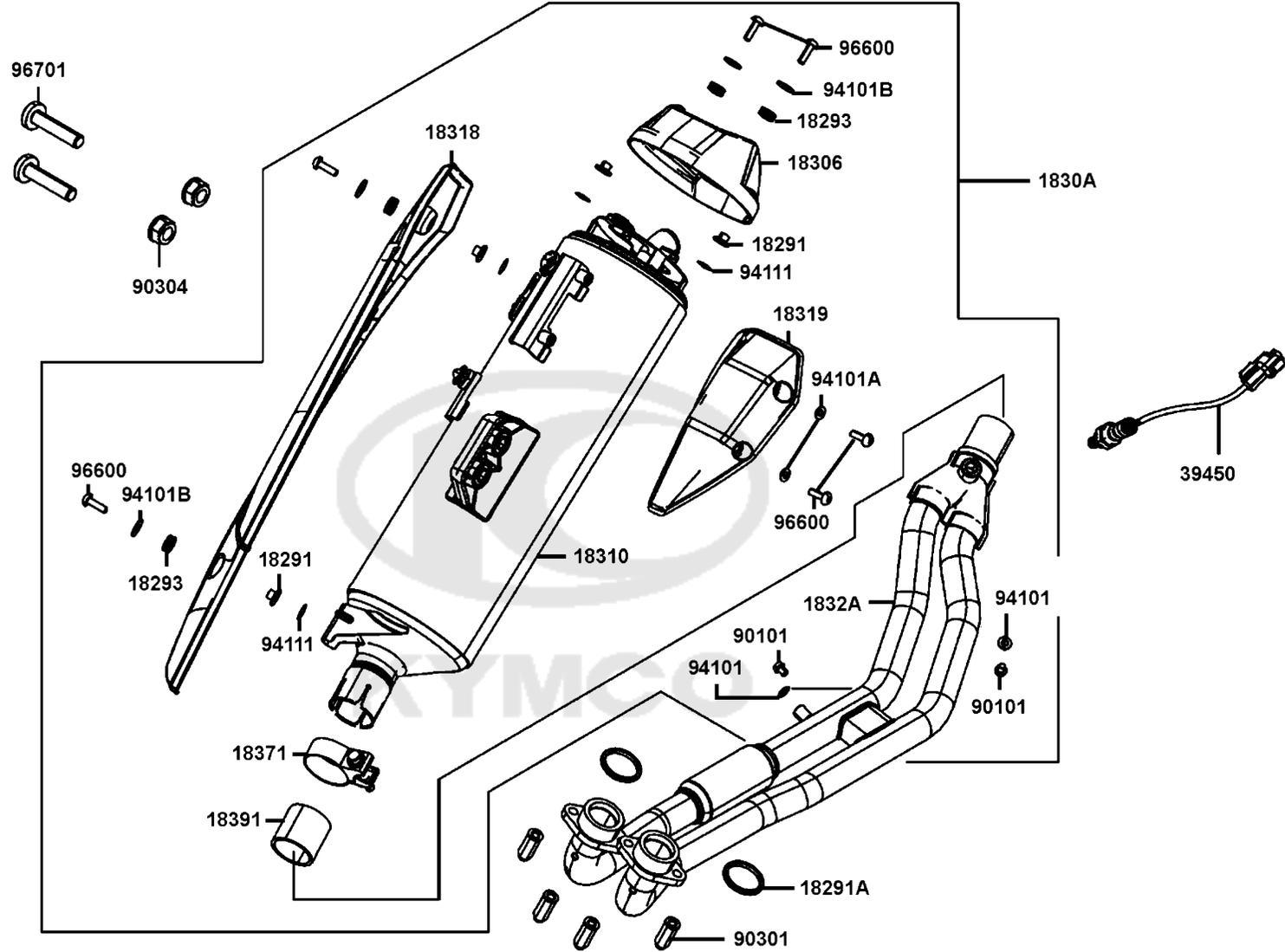

Sales mark	Ref no	Part no	Description	Reg description	Regd no	F15
	18291	18291-LKG2-90A	COLLAR	COLLAR	4	
	18291A	18291-PWB1-900	SEAL EXHAUST PIPE	SEAL EXHAUST PIPE	2	
	18293	18293-LHJ8-900	RUBBER PKG PROTR	RUBBER PKG PROTR	4	
**	18306	18306-LGC6-E00	TAIL CAP. MUFFLER	TAIL CAP. MUFFLER	1	
**	1830A	1830A-LGC6-EY5	MUFFLER ASSY EXHAUST	MUFFLER ASSY EXHAUST	1	
	18310	18310-LGC6-EY5	MUFFLER COMP	MUFFLER COMP	1	
**	18318	18318-LGC6-E00	MUFF. PROTECTOR	MUFF. PROTECTOR	1	
**	18319	18319-LGC6-E00	COVER. SILENCER	COVER. SILENCER	1	
	1832A	1832A-LGC6-EZ5	PIPE ASSY EXHAUST	PIPE ASSY EXHAUST	1	
	18371	18371-LBA2-E00	BAND MUFFLER	BAND MUFFLER	1	
	18391	18391-LKF5-E00	PACKING. MUFFLER	PACKING. MUFFLER	1	
	39450	39450-ZVA6-M00	O2 SENSOR	O2 SENSOR	1	
	90101	90101-LEA7-E00	BOLT FLANGE SH 6X8	BOLT FLANGE SH 6X8	2	
	90301	90301-GFY6-901	NUT (HEX) CAP 8MM	NUT (HEX) CAP 8MM	4	
	90304	90304-LGC6-E00	NUT M10X1.25(C)	NUT M10X1.25(C)	2	
	94101	94101-06200	WASHER PLAIN 6MM	WASHER PLAIN 6MM	2	
	94101A	94101-LDB5-E00	WASHER. PLAIN. 6mm	WASHER. PLAIN. 6mm	2	
	94101B	94101-LEA2-900	WASHER PLAIN 6.5*18*1.5	WASHER PLAIN 6.5*18*1.5	4	
	94111	94111-ACD5-E00	WASHER.SPG	WASHER.SPG	4	
	96600	96600-LEA7-E01	SOCKET BOLT 6X20	SOCKET BOLT 6X20	6	

F15

Exhaust Muffler

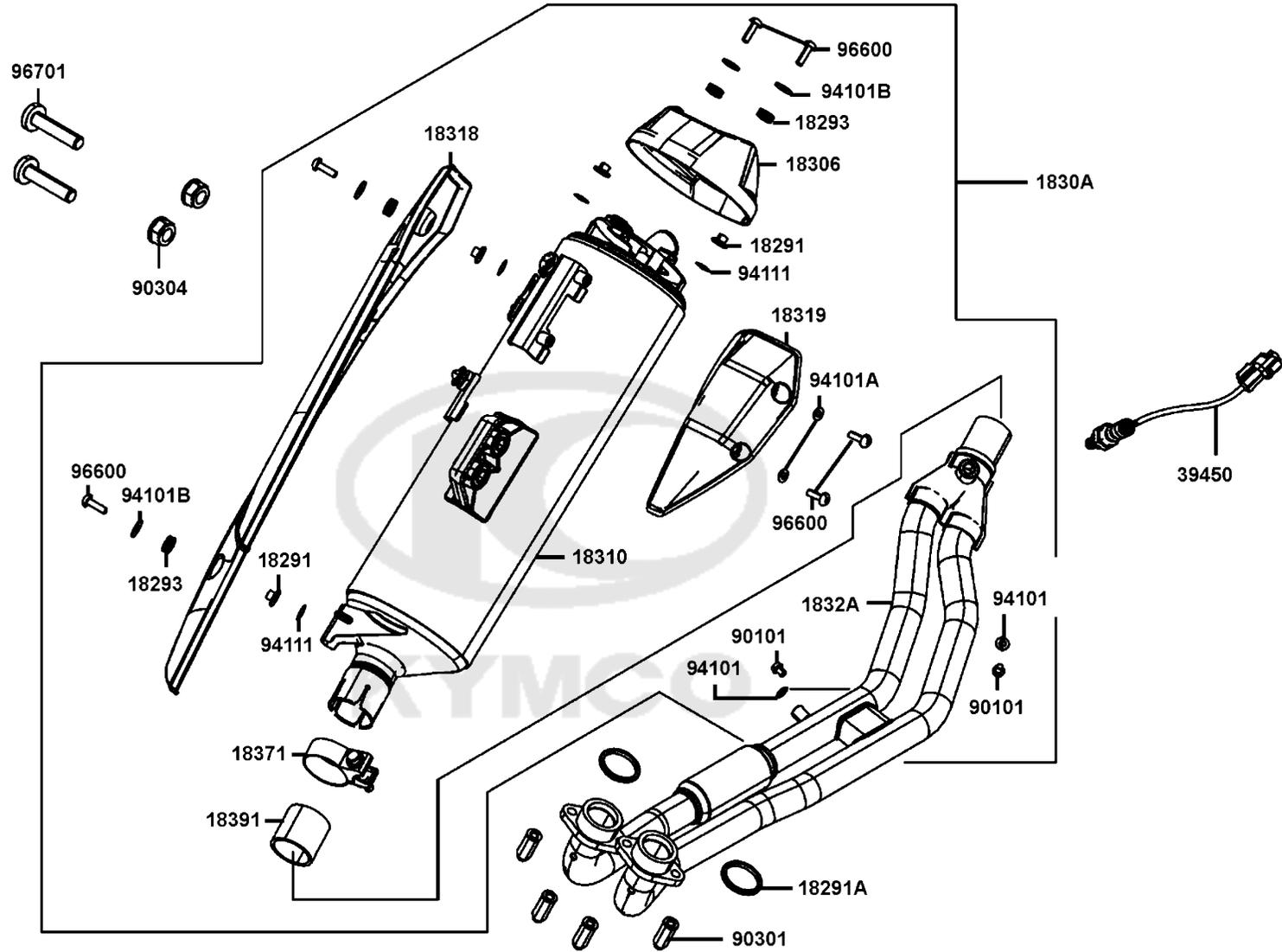

Sales mark	Ref no	Part no	Description	Reg description	Regd no	F15
------------	--------	---------	-------------	-----------------	---------	------------

96701

96701-LGC6-E01

SOCKET BOLT 10X45

SOCKET BOLT 10X45

2



F16

Fr Body FrameStand

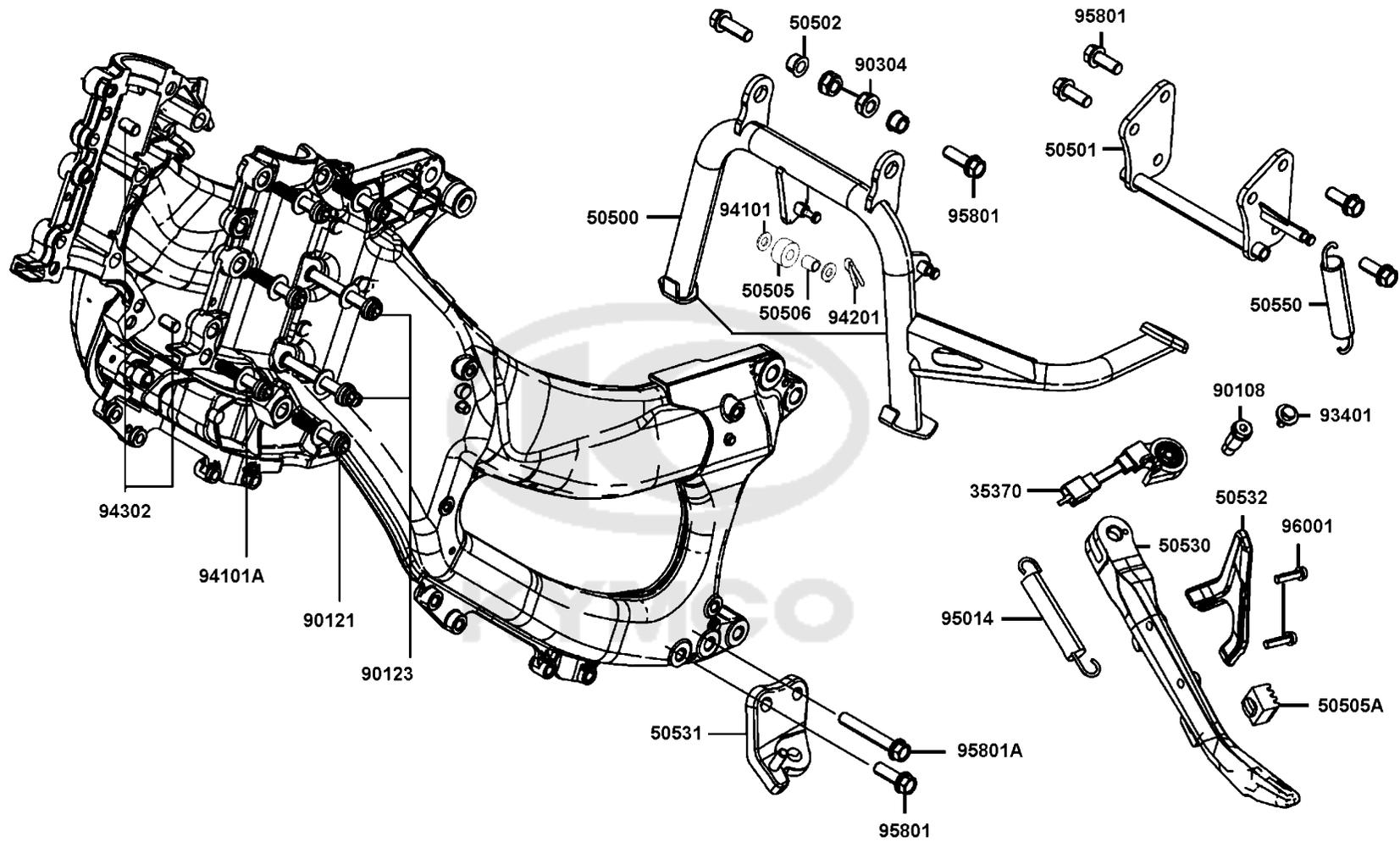

Sales mark	Ref no	Part no	Description	Reg description	Regd no	F16
	35370	35370-ZZA6-E00	SW UNIT SIDE STAND	SW UNIT SIDE STAND	1	
	50500	50500-AKB8-E00	STAND COMP MAIN	STAND COMP MAIN	1	
	50501	50501-LGC6-E00	BRKT MAIN STAND	BRKT MAIN STAND	1	
	50502	50502-GFY6-901	COLLAR MAIN STAND	COLLAR MAIN STAND	2	
	50505	50505-LEA7-E00	STOPPER RUBBER	STOPPER RUBBER	1	
	50505A	50505-LKB9-900	RUBBER SIDE STAND	RUBBER SIDE STAND	1	
	50506	50506-KHE7-E00	COLLAR STOPPER RUBBER	COLLAR STOPPER RUBBER	1	
	50530	50530-LGC6-E00	STAND BAR SIDE	STAND BARSIDE	1	
	50531	50531-LGC6-E00	BRKT.SIDE STAND	BRKT.SIDE STAND	1	
	50532	50532-AKB8-E00	KICK BAR SIDE STAND	KICK BAR SIDE STAND	1	
	50550	50550-KKC2-E00	SPG ASSY MAIN STAND	SPG ASSY MAIN STAND	1	
	90108	90108-LGC6-E00	SCREW SIDE STAND PINOT	SCREWSIDE STAND PINOT	1	
	90121	90121-LGC6-E00	BOLT FLANGE 10X50	BOLT FLANGE 10X50	2	
	90123	90123-LGC6-E00	BOLT FLANGE 10X95	BOLT FLANGE 10X95	2	
	90304	90304-LEA1-900	NUT U FLANGE 10MM	NUT U FLANGE 10MM	2	
	93401	93401-06020-07	BOLT WASHER 6*20	BOLT WASHER 6*20	1	
	94101	94101-08600	WASH PLAIN 8MM	WASH PLAIN 8MM	2	
	94101A	94101-10000	WASHER PLAIN 10MM	WASHER PLAIN 10MM	7	
	94201	94201-20180	PIN SPLIT 2.0*18	PIN SPLIT 2.0*18	1	
	94302	94302-10160	LOCK PIN	LOCK PIN	2	

F16

Fr Body FrameStand

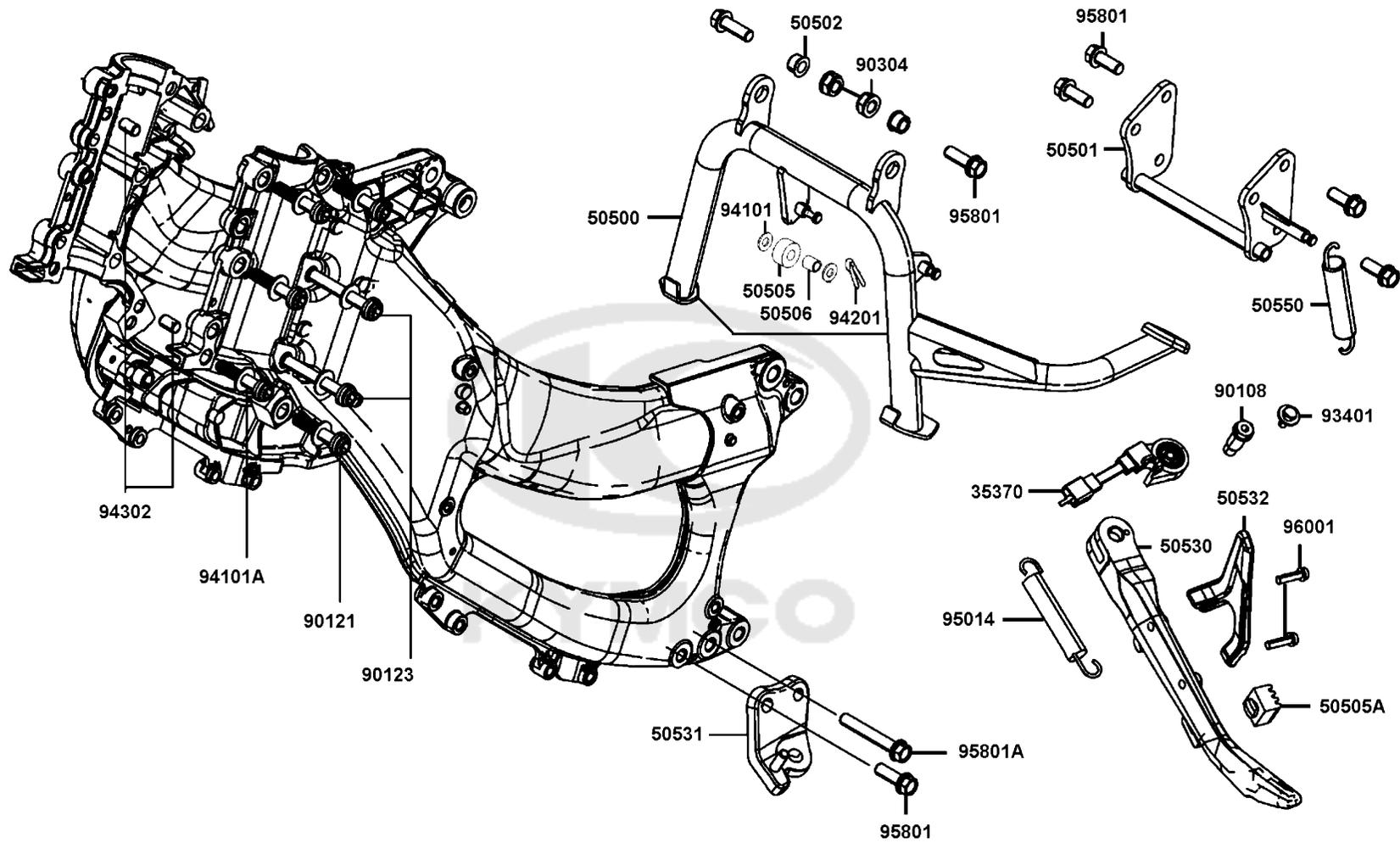

Sales mark	Ref no	Part no	Description	Reg description	Regd no	F16
95014	95014-72204	SPG B1 SIDE STAND	SPG B1 SIDE STAND	SPG B1 SIDE STAND	1	
95801	95801-10030-06	BOLT FLANGE 10X30	BOLT FLANGE 10X30	BOLT FLANGE 10X30	3	
95801A	95801-10065-06	BOLT FLANGE 10*65	BOLT FLANGE 10*65	BOLT FLANGE 10*65	1	
96001	96001-06022-06	BOLT FLANGE SH 6X22	BOLT FLANGE SH 6X22	BOLT FLANGE SH 6X22	2	



Sales mark	Ref no	Part no	Description	Reg description	Regd no	F17
	23800	23800-AKB8-E00	DRIVE ASSY TRANS BELT	DRIVE ASSY TRANS BELT	1	
**	40510	40510-LGC6-E00	COVER UP A CHAIN	COVER UP A CHAIN	1	
**	40511	40511-LGC6-E01	COVER UP B CHAIN	COVER UP B CHAIN	1	
	40512	40512-LGC6-E00	COVER UP C CHAIN	COVER UP C CHAIN	1	
**	40520	40520-LGC6-E00	COVER LOW A CHAIN	COVER LOW A CHAIN	1	
**	40521	40521-LGC6-E00	COVER LOW B CHAIN	COVER LOW B CHAIN	14	
	40522	40522-LGC6-E00	COVER LOW C CHAIN	COVER LOW C CHAIN	1	
	50504	50504-LGC6-E00	PLATE MAIN STAND TOPPER	PLATE MAIN STAND TOPPER	1	
**	52100	52100-AKB8-E00	FORK ASSY RR L/H	FORK ASSY RR L/H	1	
**	52120	52120-AKB8-E00	FORK CAST RR R/H	FORK CAST RR R/H	1	
**	52130	52130-AKB8-E00	HOLDER ASSY FINAL SHAFT	HOLDER ASSY FINAL SHAFT	1	
**	52133	52133-LGC6-E00	CAP FINAL SHAFT HOLDER	CAP FINAL SHAFT HOLDER	1	
	52134	52134-LGC6-E00	GASKET RR FORK CAP	GASKET RR FORK CAP	1	
**	52400	52400-AKB8-E00	CUSHION ASSY RR	CUSHION ASSY RR	1	
	52415	52415-LGC6-E00	COLLAR RR CUSHION	COLLAR RR CUSHION	2	
	64206	64206-MLJ0-001	NUT SPEED 4MM	NUT SPEED 4MM	1	
	90101	90101-LGC6-E00	AXLE RR SWING PIVOT	AXLE RR SWING PIVOT	1	
	90102	90102-LGC6-E00	COLLAR RR FORK PIVOT	COLLAR RR FORK PIVOT	1	
	90110	90110-KED9-900	SCREW PAN 6*18	SCREW PAN 6*18	4	
	90201	90201-LGC6-E00	NUT STRG STEM	NUT STRG STEM	1	

F17

Rear Cushion

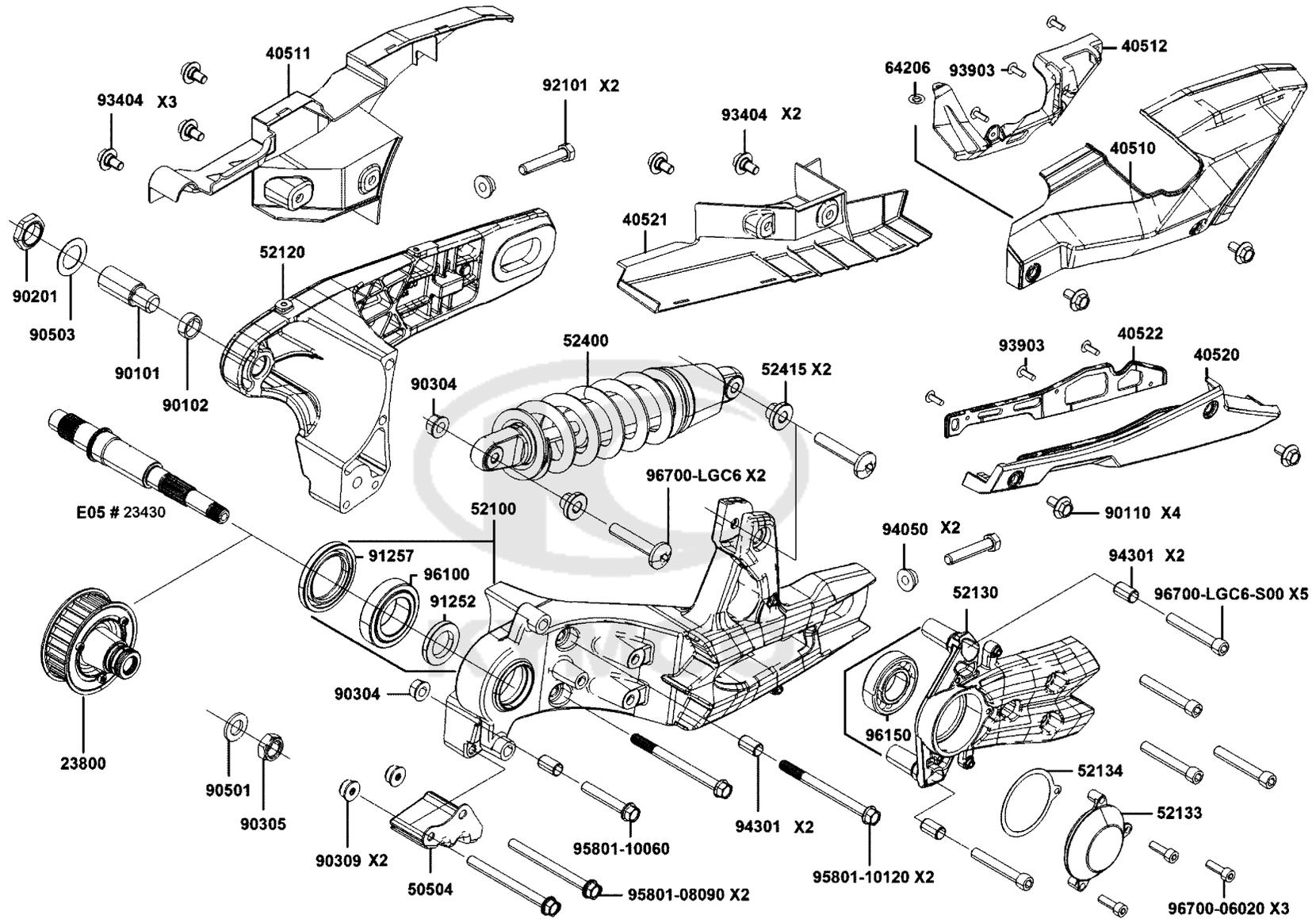

Sales mark	Ref no	Part no	Description	Reg description	Regd no	F17
	90304	90304-LEA1-900	NUT U FLANGE 10MM	NUT U FLANGE 10MM	2	
	90305	90305-KNBN-90B	NUT U 16MM	NUT U 16MM	1	
	90309	90309-GLW0-90A	NUT U FLANGE 8MM	NUT U FLANGE 8MM	2	
	90501	90501-KNBN-901	WASHER 16MM	WASHER 16MM	1	
	90503	90503-0A51-870	WASHER STEERING STEM NUT	WASHER STEERING STEM NUT	1	
	91252	91252-LGC6-E00	OIL SEAL 28X45X7	OIL SEAL 28X45X7	1	
	91257	91257-LGC6-E00	OIL SEAL 48X72X8	OIL SEAL 48X72X8	1	
	92101	92101-LGC6-E00	BOLT FEX 8X45	BOLT FEX 8X45	2	
	93404	93404-06012-06	BOLT WASHER 6X12	BOLT WASHER 6X12	4	
	93903	93903-24360	SCREW TAPPING 4*12	SCREW TAPPING 4*12	6	
	94050	94050-08020	NUT FLANGE 8MM	NUT FLANGE 8MM	2	
	94301	94301-12200	DOWEL PIN 12*20	DOWEL PIN 12*20	2	
	95801-08090	95801-08090-06	BOLT FLANGE 8*90	BOLT FLANGE 8*90	2	
	95801-10060	95801-10060-06	BOLT FLANGE 10*60	BOLT FLANGE 10*60	1	
	95801-10120	95801-10120-06	BOLT FLANGE 10*120	BOLT FLANGE 10*120	2	
	96100	96100-LGC6-E00	TAPPER BEARING 4T-32008X	TAPPER BEARING 4T-32008X	1	
	96150	96150-62060-10	BEARING 6206UU	BEARING 6206UU	1	
	96700-06020	96700-06020-06	SOCKET BOLT 6X20	SOCKET BOLT 6X20	3	
	96700-LGC6	96700-LGC6-E00	SOCKET BOLT 10X58	SOCKET BOLT 10X58	2	
	96700-LGC6-S00	96700-LGC6-S00	BOLT 10X65	BOLT 10X65	1	

F18

Front Winker RR WINKER

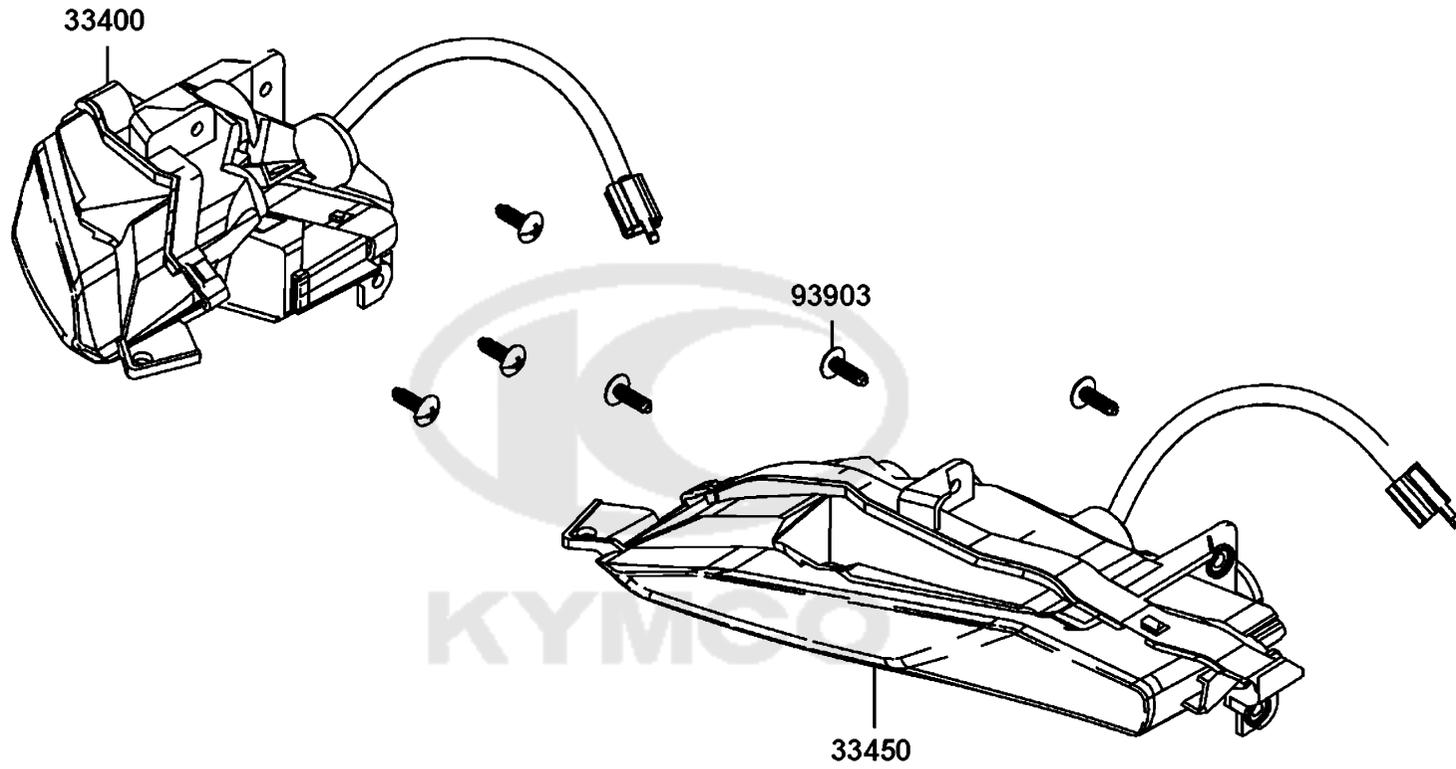

Sales mark	Ref no	Part no	Description	Reg description	Regd no	F18
------------	--------	---------	-------------	-----------------	---------	------------

33400		33400-LGC6-E00	WINKER ASSY.. R. FR	WINKER ASSY.. R. FR	1	
33450		33450-LGC6-E00	WINKER ASSY.. L. FR	WINKER ASSY.. L. FR	1	
93903		93903-35260	SCREW TAPPING 5*12	SCREW TAPPING 5*12	6	



F19

Rear Light Rear Fender

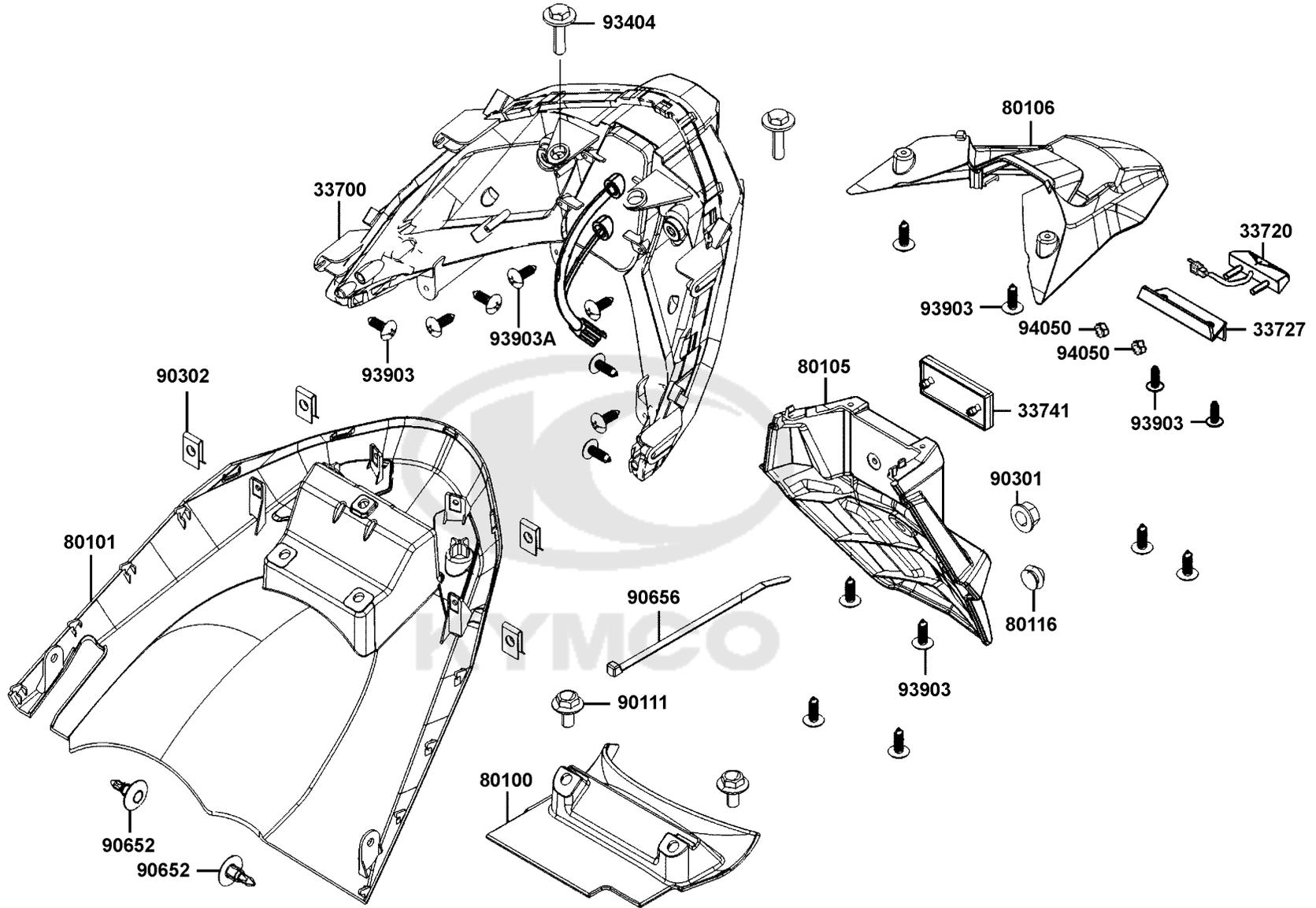

Sales mark	Ref no	Part no	Description	Reg description	Regd no	F19
	33700	33700-LGC6-E00	LIGHT ASSY.. RR. COMB.	LIGHT ASSY.. RR. COMB.	1	
	33720	33720-LGC6-305	LIGHT SET LICENSE	LIGHT SET LICENSE	1	
	33727	33727-LGC6-E00	STAY	STAY	1	
	33741	33741-ACH7-900	REFLEX REFLECTOR	REFLEX REFLECTOR	1	
**	80100	80100-LGC6-E00	FENDER RR TIRE	FENDER RR TIRE	1	
**	80101	80101-AKB8-E00	FENDER RR INNER	FENDER RR INNER	1	
**	80105	80105-AKB8-E00	FENDER A REAR	FENDER A REAR	1	
**	80106	80106-AKB8-E00	FENDER B REAR	FENDER B REAR	1	
	80116	80116-AEG9-900	RUBBER LICENSE PLATE STOP	RUBBER LICENSE PLATE STOP	1	
	90111	90111-LEB1-900	BOLT FLANGE 6MM	BOLT FLANGE 6MM	2	
	90301	90301-6D34-671	NUT FLANGE 6MM	NUT FLANGE 6MM	1	
	90302	90302-SDA4-004	NUT SPRING 4MM	NUT SPRING 4MM	2	
	90652	90652-LCA4-E00	CLIP MUDGUARD	CLIP MUDGUARD	2	
	90656	90656-KCBC-900	BAND OIL HANDLE 8X146	BAND OIL HANDLE 8X146	1	
	93404	93404-06012-06	BOLT WASHER 6X12	BOLT WASHER 6X12	2	
	93903	93903-24360	SCREW TAPPING 4*12	SCREW TAPPING 4*12	6	
	93903A	93903-GFY6-900	SCREW TAPPING 4*14	SCREW TAPPING 4*14	4	
	94050	94050-LHJ3-900	NUT M4*0.7	NUT M4*0.7	2	

F20

Wire Harness

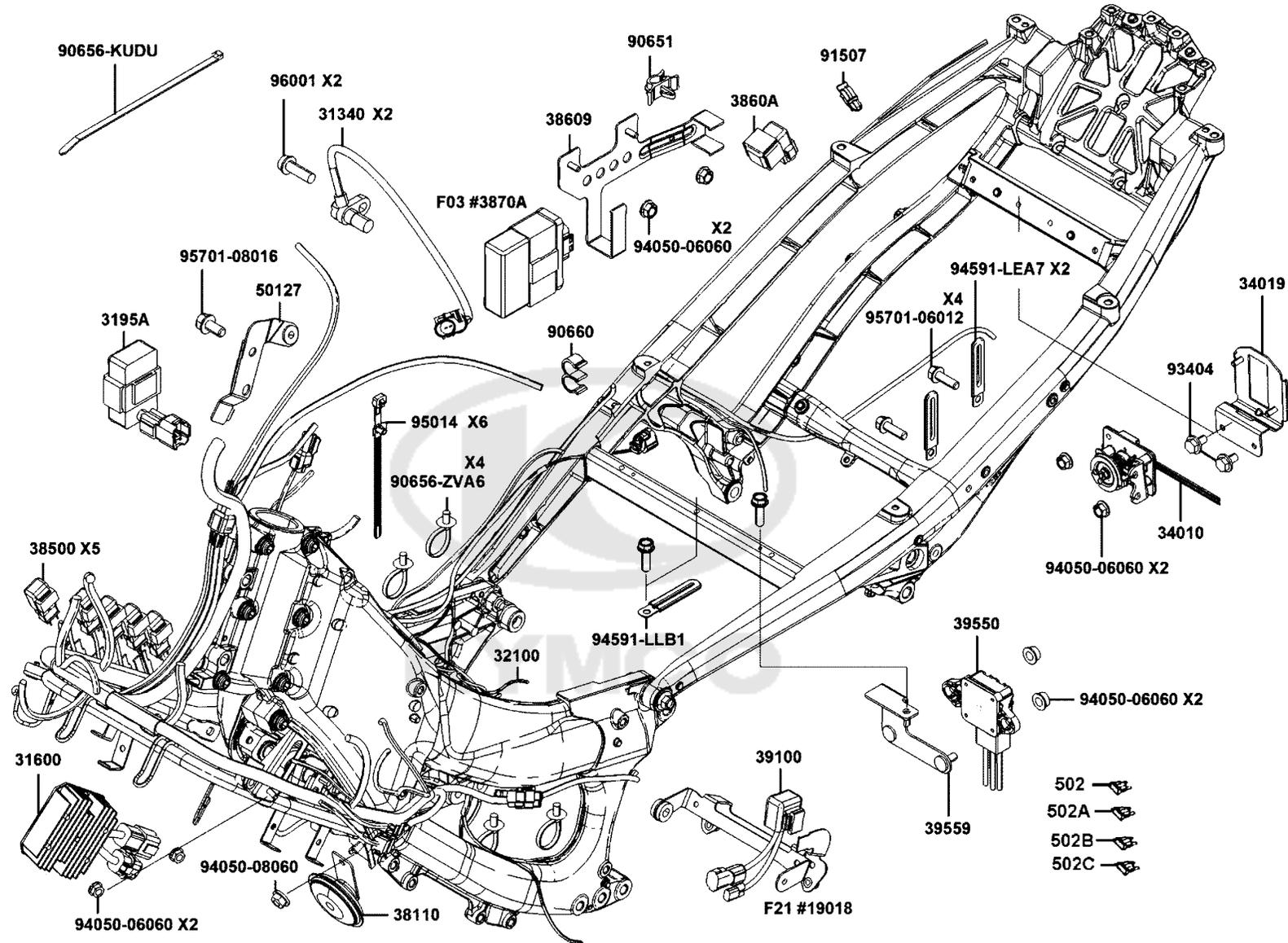

Sales mark	Ref no	Part no	Description	Reg description	Regd no	F20
	31340	31340-LEA7-E00	SENSOR FR WHEEL SPEED	SENSOR FR WHEEL SPEED	1	
	31600	31600-ZXA6-M01	REG RECT COMP	REG RECT COMP	1	
	3195A	3195A-LBA7-E00	HAZARD CONTROL ASSY	HAZARD CONTROL ASSY	0	
	32100	32100-AKB8-E01	HARNESS WIRE	HARNESS WIRE	1	
	34010	34010-AKB8-E00	THROTTLE CONTROL, GRIP	THROTTLE CONTROL, GRIP	1	
	34019	34019-AKB8-E00	STAY,GRIP POSITION DETECTO	STAY,GRIP POSITION DETECTO	1	
	38500	38500-LGL3-90A	RELAY ASSY LIGHT/D402(12V 20A)	RELAY ASSY LIGHT/D402(12V 20A)	1	
	38609	38609-AKB8-E00	STAY KEYLESS CONTROLLER	STAY KEYLESS CONTROLLER	1	
	3860A	3860A-ADG5-E00	CONTROLLER ASS'Y HEAD LIGHT	CONTROLLER ASS'Y HEAD LIGHT	1	
	39100	39100-LGC6-E00	EMI FILTER. FAN MOTOR	EMI FILTER. FAN MOTOR	1	
	39550	39550-AKB8-E00	IMU	IMU	1	
	39559	39559-AKB8-E00	STAY IMU	STAY IMU	1	
	50127	50127-AKB8-E00	STAY KEYKES CASE	STAY KEYKES CASE	1	
	502	502-00149	BLADE FUSE MINI 15A	BLADE FUSE MINI 15A	3	
	502A	502-00151	BLADE FUSE MINI 10A	BLADE FUSE MINI 10A	4	
	502B	502-00155	BLADE FUSE MINI 25A	BLADE FUSE MINI 25A	1	
	502C	502-00164	BLADE FUSE MINI 5A	BLADE FUSE MINI 5A	1	
	90651	90651-LEA2-900	CLIP TUBE	CLIP TUBE	1	
**	90656-KUDU	90656-KUDU-900	BAND HARNESS WIRE	BAND HARNESS WIRE	22	
	90656-ZVA6	90656-ZVA6-M00	CABLE STRAP	CABLE STRAP	4	

F20

Wire Harness

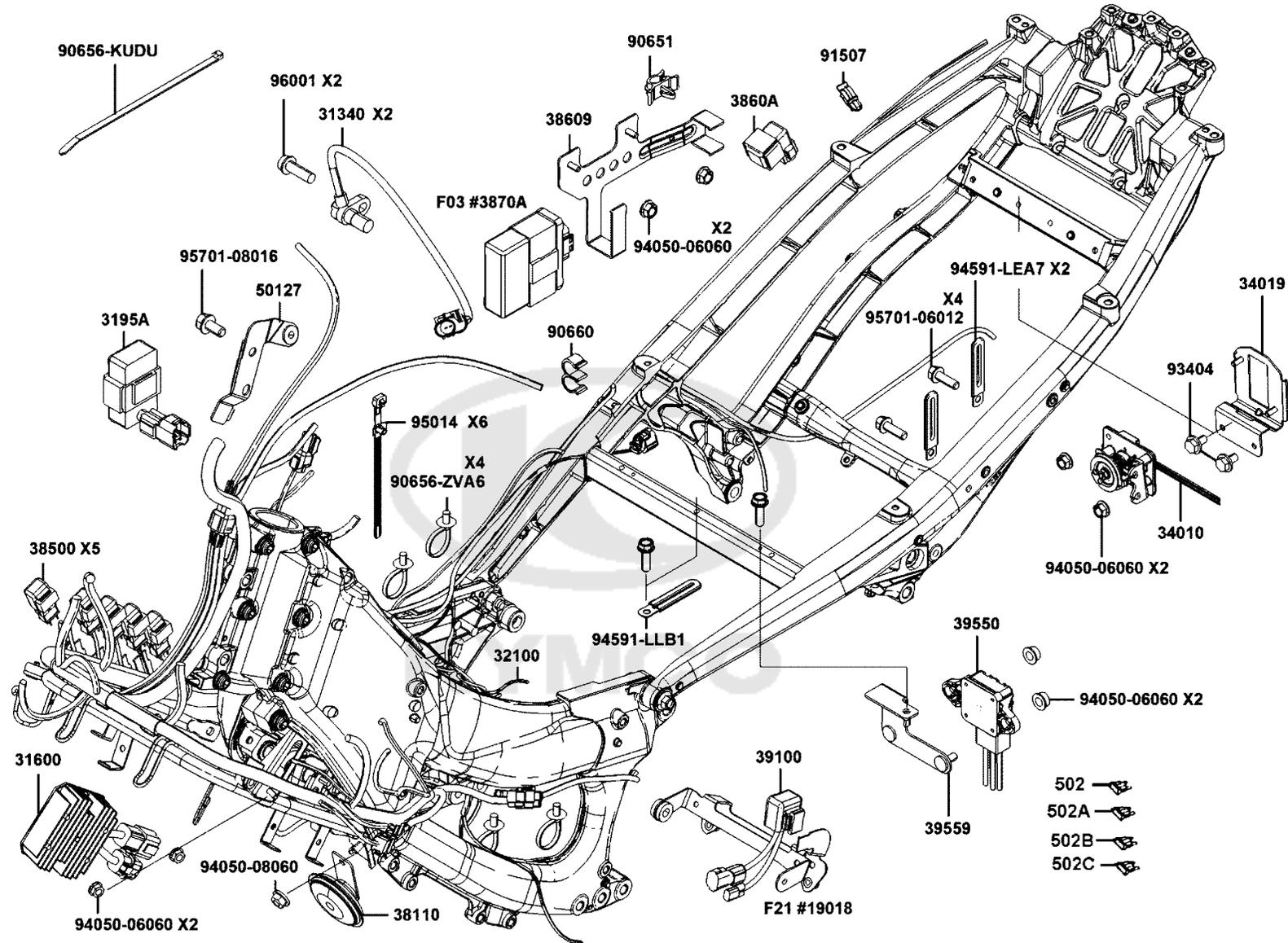

Sales mark	Ref no	Part no	Description	Reg description	Regd no	F20
90660		90660-LDE9-E00	CLAMP TUBE	CLAMP TUBE	1	
91507		91507-LKE6-900	CLIP	CLIP	1	
93404		93404-LLF5-910	BOLT WASHER 6X12	BOLT WASHER 6X12	2	
94050-06060		94050-06060	NUT FLANGE 6MM	NUT FLANGE 6MM	10	
94050-08060		94050-08060	NUT FLANGE 8MM	NUT FLANGE 8MM	1	
94591-LEA7		94591-LEA7-E01	CLIP 2X150	CLIP 2X150	2	
94591-LLB1		94591-LLB1-900	CLIP 2*100	CLIP 2*100	1	
95014		95014-PRB3-900	STRAP CABLE	STRAP CABLE	5	
95701-06012		95701-06012-06	BOLT FLANGE 6X12	BOLT FLANGE 6X12	4	
95701-08016		95701-08016-06	BOLT FLANGE 8*16	BOLT FLANGE 8*16	1	
96001		96001-06012-06	BOLT FLANGE SH 6*12	BOLT FLANGE SH 6*12	2	

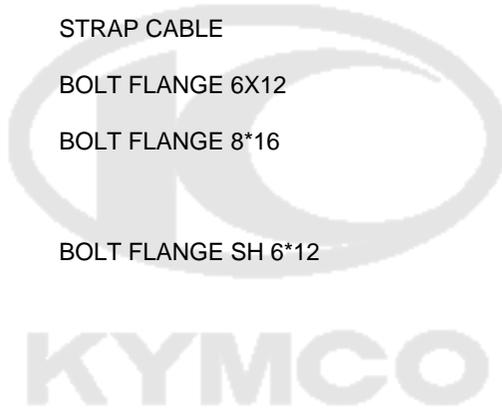

F21

Frame Body

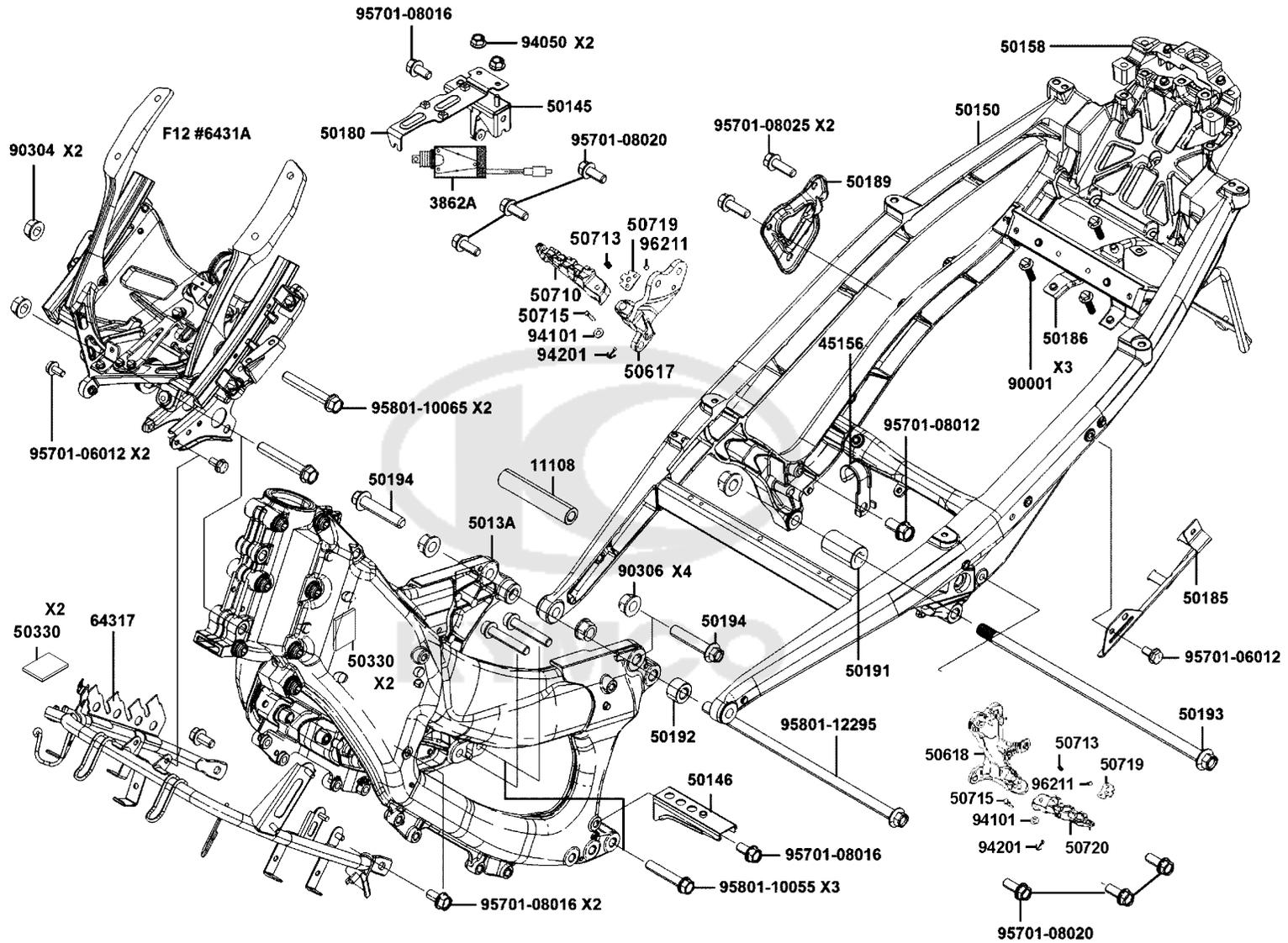

Sales mark	Ref no	Part no	Description	Reg description	Regd no	F21
	11108	11108-LGC6-E00	HOLDER. STATOR WIRE	HOLDER. STATOR WIRE	1	
	3862A	3862A-AKB8-E00	SOLENOID ASSY	SOLENOID ASSY	1	
	45156	45156-AKB8-E00	CLAMPER HOSE FR	CLAMPER HOSE FR	1	
	5013A	5013A-AKB8-E00	BODY ASSY FR FRAME	BODY ASSY FR FRAME	1	
	50145	50145-AKB8-E00	RR STAY R FLOOR PANEL	RR STAY R FLOOR PANEL	1	
	50146	50146-AKB8-E00	RR STAY L FLOOR PANEL	RR STAY L FLOOR PANEL	1	
	50150	50150-LGC6-E00	BODY ASSY RR FRAME	BODY ASSY.RR FRAME	1	
#	50158	50158-AKB8-E01	BRACKET CARRIER	BRACKET CARRIER	1	
	50180	50180-AKB8-E00	STAY LINEAR MOTOR	STAY LINEAR MOTOR	1	
	50185	50185-AKB8-E00	STAY CANISTER	STAY CANISTER	1	
	50186	50186-AKB8-E00	STAY RR FENDER	STAY RR FENDER	1	
	50189	50189-LGC6-E00	BRKT MUFFLER	BRKT MUFFLER	1	
	50191	50191-LGC6-E00	COLLAR R RR ENG MOUNTING	COLLAR R RR ENG MOUNTING	1	
	50192	50192-LGC6-E00	COLLAR L FR ENG MOUNTING	COLLAR L FR ENG MOUNTING	1	
	50193	50193-LGC6-E00	BOLT FLANGE 12X315	BOLT FLANGE 12X315	1	
	50194	50194-LGC6-E00	BOLT FLANGE 12X60	BOLT FLANGE 12X60	1	
	50330	50330-LKF5-E00	SPONGE BATTERY CASE	SPONGE BATTERY CASE	4	
	50617	50617-LGC6-E00	BRKT R PILLION STEP	BRKT R PILLION STEP	1	
	50618	50618-LGC6-E00	ERKT L PILLION STEP	BRKT L PILLION STEP	1	
**	50710	50710-ACH6-900	ARM R PILLION STEP	ARM R PILLION STEP	1	

F21

Frame Body

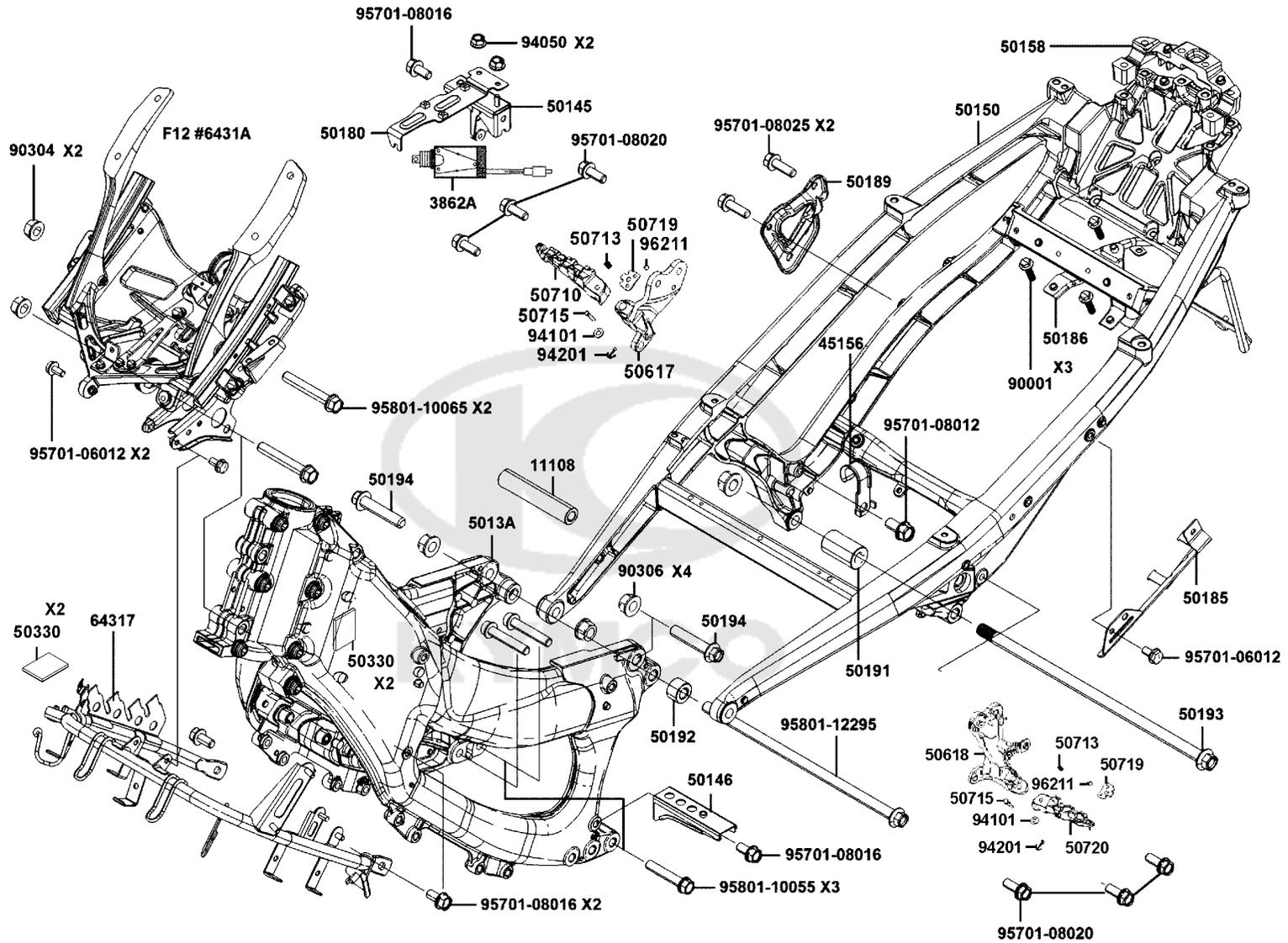

Sales mark	Ref no	Part no	Description	Reg description	Regd no	F21
	50713	50713-KEB7-900	SPRING	SPRING	1	
	50715	50715-KKAK-900	PIN RR STEP	PIN RR STEP	2	
	50719	50719-LGC6-E00	PLATE PILLION STEP	PLATE PILLION STEP	2	
**	50720	50720-ACH6-900	ARM L PILLION STEP	ARM L PILLION STEP	1	
	64317	64317-AKB8-E00	UNDER PIPE FR COVER BRKT	UNDER PIPE FR COVER BRKT	1	
	90001	90001-GBHB-661	BOLT FLANGE SH 6*22	BOLT FLANGE SH 6*22	3	
	90304	90304-LEA1-900	NUT U FLANGE 10MM	NUT U FLANGE 10MM	2	
	90306	90306-LFE2-900	NUT FLANGE 12MM	NUT FLANGE 12MM	4	
	94050	94050-06060	NUT FLANGE 6MM	NUT FLANGE 6MM	2	
	94101	94101-06000	WASHER PLAIN 6MM	WASHER PLAIN 6MM	2	
	94201	94201-20120	PIN SPLIT 2*12	PIN SPLIT 2*12	2	
	95701-06012	95701-06012-06	BOLT FLANGE 6X12	BOLT FLANGE 6X12	3	
	95701-08012	95701-08012-06	BOLT FLANGE 8*12	BOLT FLANGE 8*12	1	
	95701-08016	95701-08016-06	BOLT FLANGE 8*16	BOLT FLANGE 8*16	4	
	95701-08020	95701-08020-06	BOLT FLANGE 8*20MM **07 C.2005.07.01	BOLT FLANGE 8*20MM **07 C.2005.07.01	6	
	95701-08025	95701-08025-06	BOLT FLANGE 8*25	BOLT FLANGE 8*25	2	
	95801-10055	95801-10055-06	BOLT FLANGE 10*55	BOLT FLANGE 10*55	3	
	95801-10065	95801-10065-06	BOLT FLANGE 10*65	BOLT FLANGE 10*65	2	
	95801-12295	95801-12295-06	BOLT FLANGE 12X295	BOLT FLANGE 12X295	1	
	96211	96211-08000	BALL STEEL #8	BALL STEEL #8	2	

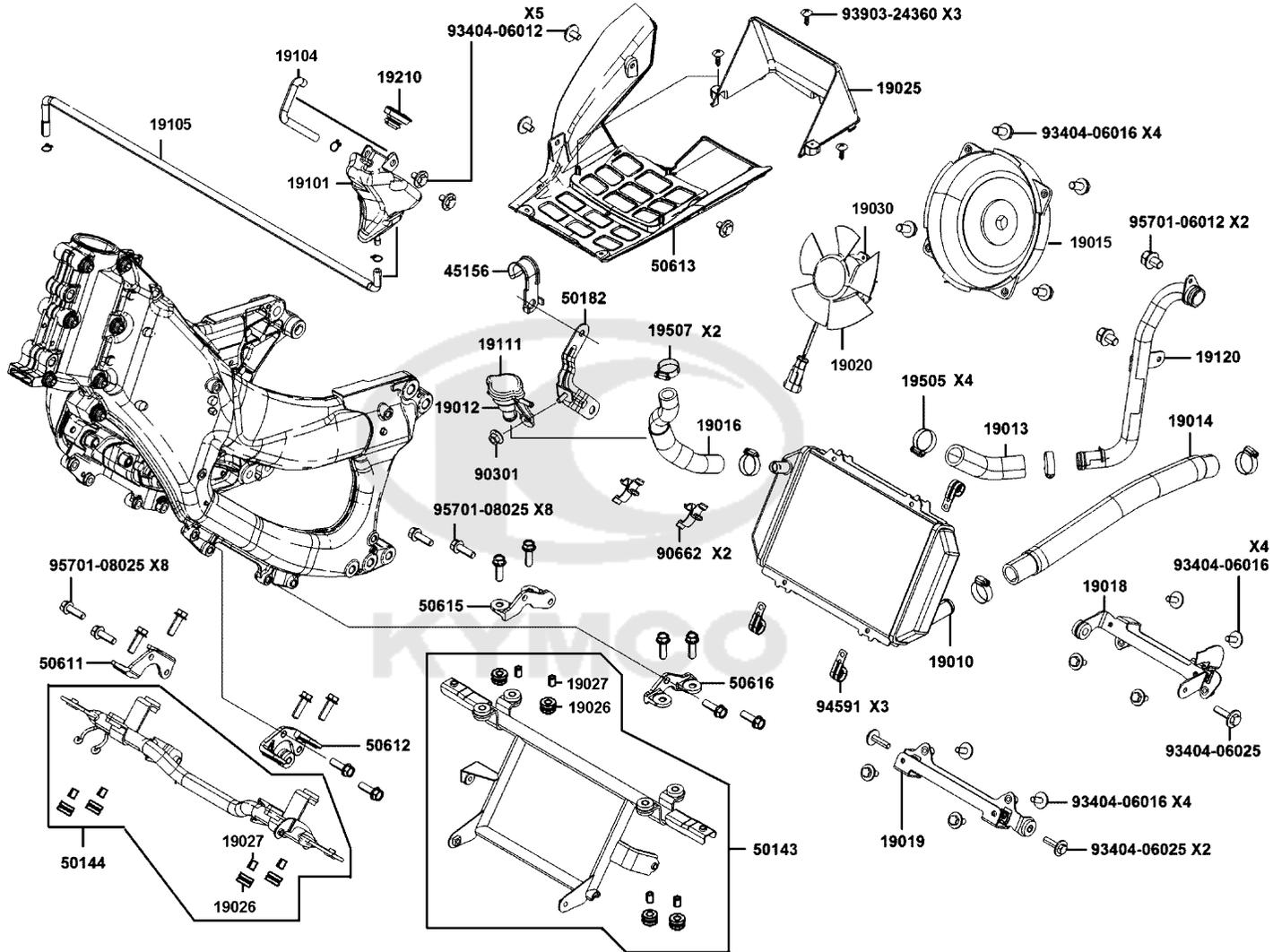

Sales mark	Ref no	Part no	Description	Reg description	Regd no	F22
	19010	19010-LGC6-E00	RADIATOR COMP	RADIATOR COMP	1	
	19012	19012-LEA7-E05	UNIT RADIATOR	UNIT RADIATOR	1	
	19013	19013-LGC6-E00	HOSE WATER INLET	HOSE WATER INLET	1	
	19014	19014-LGC6-E00	HOSE WATER OUTLET	HOSE WATER OUTLET	1	
	19015	19015-LBA2-E00	SHROUD COMP	SHROUD COMP	1	
	19016	19016-LGC6-E00	HOSE WATER-UNIT CAP	HOSE WATER-UNIT CAP	1	
	19018	19018-LGC6-E00	HOLDER UPPER RADIATOR	HOLDER UPPER RADIATOR	1	
	19019	19019-LGC6-E00	HOLDER LOWER RADIATOR	HOLDER LOWER RADIATOR	1	
	19020	19020-LBA2-E00	FAN COOLING	FAN COOLING	1	
**	19025	19025-LGC6-E00	COVER RADIATOR	COVER RADIATOR	1	
	19026	19026-LKF5-E00	DAMPING RUBBER RADIATOR	DAMPING RUBBER RADIATOR	9	
	19027	19027-LKF5-E00	COLLAR RADIATOR	COLLAR RADIATOR	9	
	19030	19030-LDB5-E00	MOTOR ASSY FAN	MOTOR ASSY FAN	1	
	19101	19101-AKB8-E00	TANK RESERVE	TANK RESERVE	1	
	19104	19104-ACD5-E00	HOSE ASSY DRAIN	HOSE ASSY DRAIN	1	
	19105	19105-LGC6-E00	HOSE ASSY RESERVE TANK-PRESSURE	HOSE ASSYRESERVE TANK-PRESSURE	1	
	19111	19111-PRB3-900	CAP COMP RADIATOR	CAP COMP RADIATOR	1	
	19120	19120-LGC6-E00	PIPE WATER INLET	PIPE WATER INLET	1	
	19210	19210-KKC4-900	CAP RESERVE TANK	CAP RESERVE TANK	1	
	19505	19505-LBA2-E00	CLAMP WATER HOSE	CLAMP WATER HOSE	4	

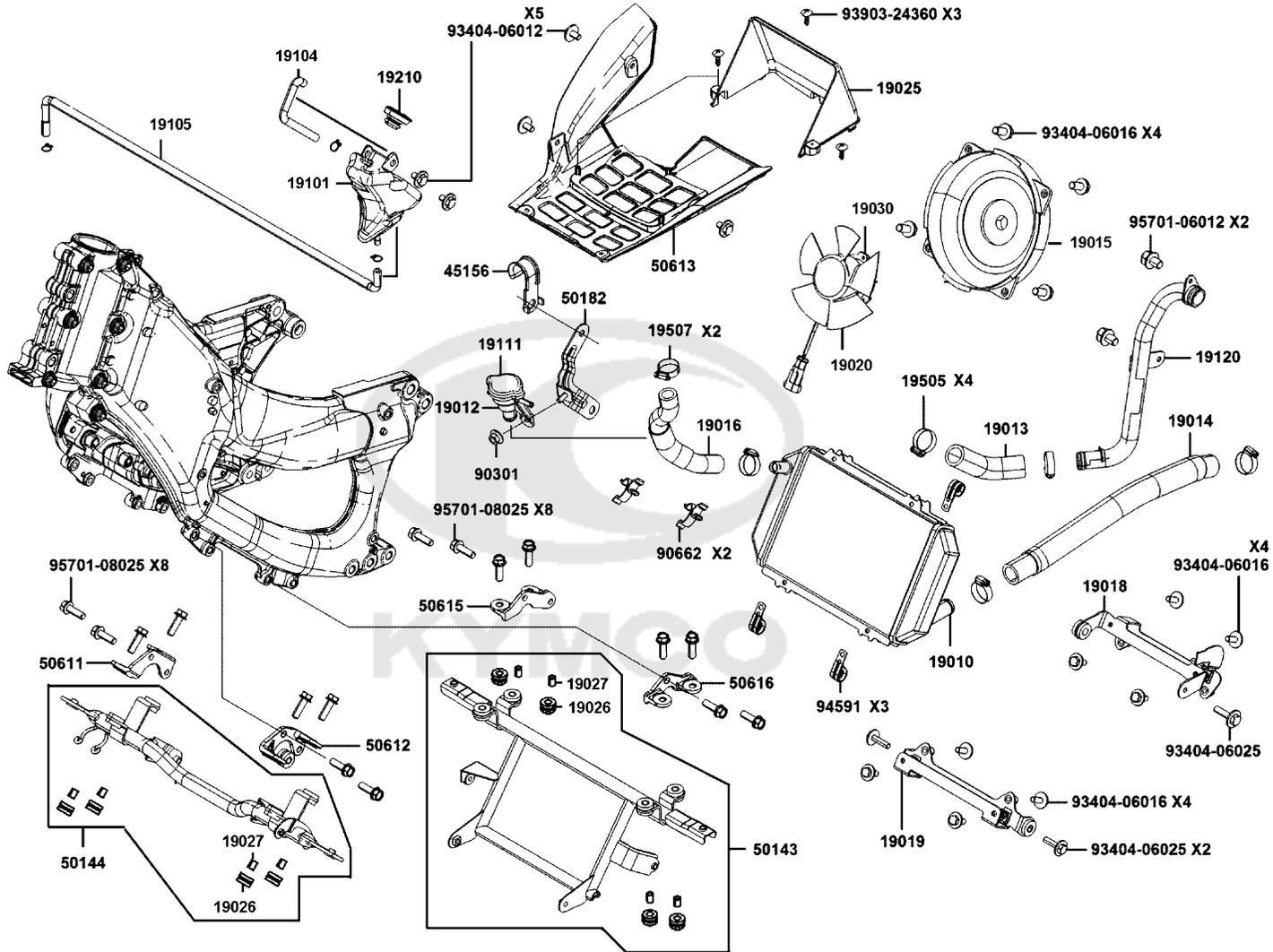

Sales mark	Ref no	Part no	Description	Reg description	Regd no	F22
	19507	19507-LDB5-E00	CLAMP D 28	CLAMP D 28	2	
	45156	45156-AKB8-E00	CLAMPER HOSE FR	CLAMPER HOSE FR	1	
	50143	50143-AKB8-E00	BRKT RADIATO	BRKT RADIATO	1	
	50144	50144-LGC6-E00	FR. STAY FLOOR PANEL	FR. STAY FLOOR PANEL	1	
	50182	50182-LGC6-E00	STAY SUPT FILLER NECK	STAY SUPT FILLER NECK	1	
	50611	50611-LGC6-E00	FR. BRKT R FLOOR PANEL	FR. BRKT R FLOOR PANEL	1	
	50612	50612-LGC6-E00	FR. BRKT L FLOOR PANEL	FR. BRKT L FLOOR PANEL	1	
**	50613	50613-AKB8-E00	COVER UNDER	COVER UNDER	1	
	50615	50615-LGC6-E00	CENTER BRKT R FLOOR PANEL	CENTER BRKT R FLOOR PANEL	1	
	50616	50616-LGC6-E00	CENTER BRKT L FLOOR PANEL	CENTER BRKT L FLOOR PANEL	1	
	90301	90301-6D34-671	NUT FLANGE 6MM	NUT FLANGE 6MM	1	
	90662	90662-LHG7-E00	CLIP WATER HOSE	CLIP WATER HOSE	2	
	93404-06012	93404-06012-06	BOLT WASHER 6X12	BOLT WASHER 6X12	5	
	93404-06016	93404-06016-06	BOLT WASHER 6*16	BOLT WASHER 6*16	12	
	93404-06025	93404-06025-06	BOLT WASHER 6*25	BOLT WASHER 6*25	3	
	93903-24360	93903-24360	SCREW TAPPING 4*12	SCREW TAPPING 4*12	3	
	94591	94591-KFBF-900	CLIP 2*70	CLIP 2*70	3	
	95701-06012	95701-06012-06	BOLT FLANGE 6X12	BOLT FLANGE 6X12	2	
	95701-08025	95701-08025-06	BOLT FLANGE 8*25	BOLT FLANGE 8*25	16	

Sales mark	Ref no	Part no	Description	Reg description	Regd no	F23
51423		51423-ADF8-E00	OIL SEAL (OUT DIA:53MM)	OIL SEAL (OUT DIA:53MM)	2	
51423		51423-KED9-900	OIL SEAL (OUT DIA. 54MM)	OIL SEAL (OUT DIA. 54MM)	1	
51424		51424-ADF8-E00	SPACER	SPACER	2	
51424		51424-KED9-900	SPACER	SPACER	1	
51427		51427-ADF8-E00	DUST SEAL	DUST SEAL	2	
51427A		51427-LGC6-E00	O-RING	O-RING	1	
51427		51427-LGC6-E02	DUST SEAL	DUST SEAL	1	
51428		51428-KED9-900	OIL SEAL STOPPER RING	OIL SEAL STOPPER RING	1	
51430		51430-LGC6-C00	OUTER TUBE (IN DIA:53MM)	OUTER TUBE (IN DIA:53MM)	2	
51431		51431-KED9-900	GUIDE BUSH	GUIDE BUSH	1	
51431A		51431-LGC6-E00	GUIDE BUSH	GUIDE BUSH	1	
51432		51432-LGC6-E00	DIST COLLAR	DIST COLLAR	1	
90544		90544-KEC8-900	PACKING	PACKING	1	
94605		94605-LGC6-E00	FORK BOLT	FORK BOLT	2	
96600		96600-LKF5-E00	BOLT	BOLT	1	

F24

Canister

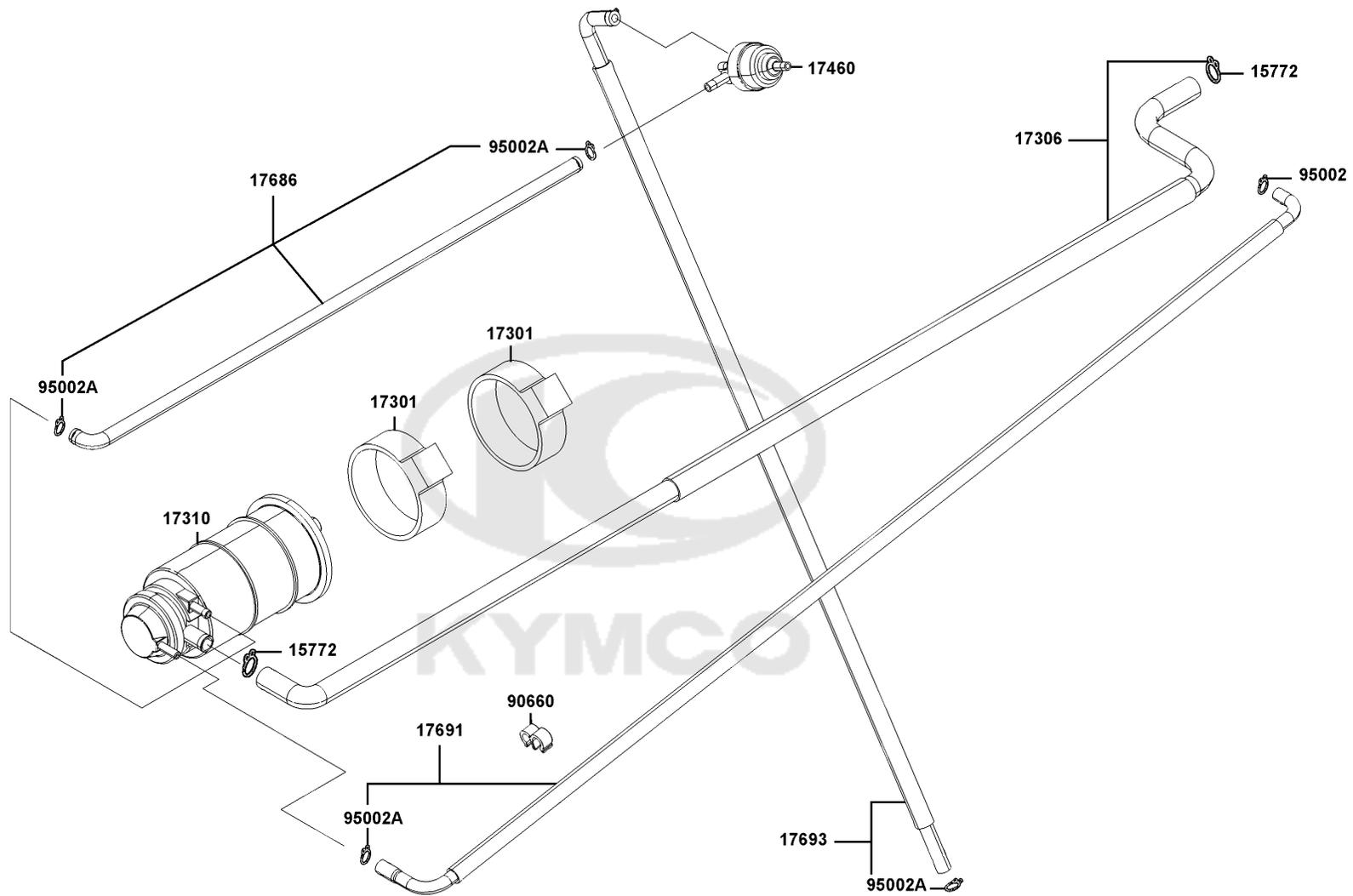

Sales mark	Ref no	Part no	Description	Reg description	Regd no	F24
15772		15772-5L00-013	CLIP B14.5 TUBE	CLIP B14.5 TUBE	2	
17301		17301-LEA7-M31	RUBBER CANISTER MOUNT	RUBBER CANISTER MOUNT	2	
17306		17306-AKB8-E00	TUBE ASSY CANISTER-AIR/C	TUBE ASSY CANISTER-AIR/C	1	
17310		17310-LGC6-E01	CANISTER COMP	CANISTER COMP	1	
17460		17460-AGA6-M01	VALVE COMP VAPOR CONTROL	VALVE COMP VAPOR CONTROL	1	
17686		17686-AKB8-E00	TUBE FUEL FILLER/CANISTER	TUBE FUEL FILLER/CANISTER	1	
17691		17691-AKB8-E00	TUBE ASSY	TUBE ASSY	1	
17693		17693-LGC6-E00	TUBE ASSY	TUBE ASSY	1	
90660		90660-PWA2-900	CLAMP TUBE	CLAMP TUBE	1	
95002		95002-02070	CLIP B7 TUBE	CLIP B7 TUBE	2	
95002A		95002-02080	CLIP B8 TUBE	CLIP B8 TUBE	4	

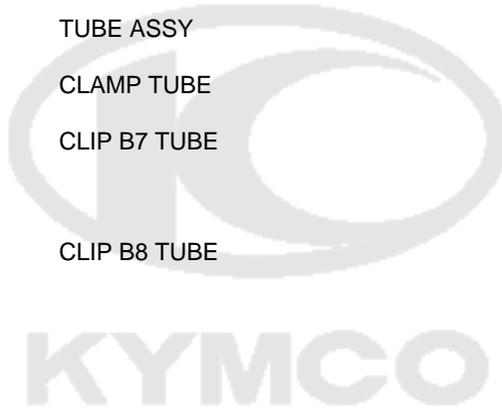



87560

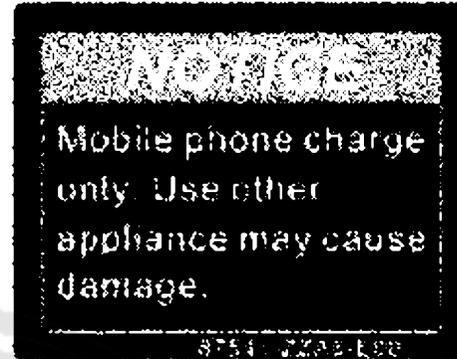

87541



87546



87515

Sales mark	Ref no	Part no	Description	Reg description	Regd no	F25
**	87515	87515-LGC6-E00	CAUTION LABEL	CAUTION LABEL	1	
**	87541	87541-ZZA6-E00	NOTICE MOBILE PHONE	NOTICE MOBILE PHONE	1	
**	87546	87546-ADG5-E00	LABEL FUEL TANK	LABEL FUEL TANK	1	
**	87560	87560-LGC6-E00	MARK DRIVER CAUTION	MARK DRIVER CAUTION	1	



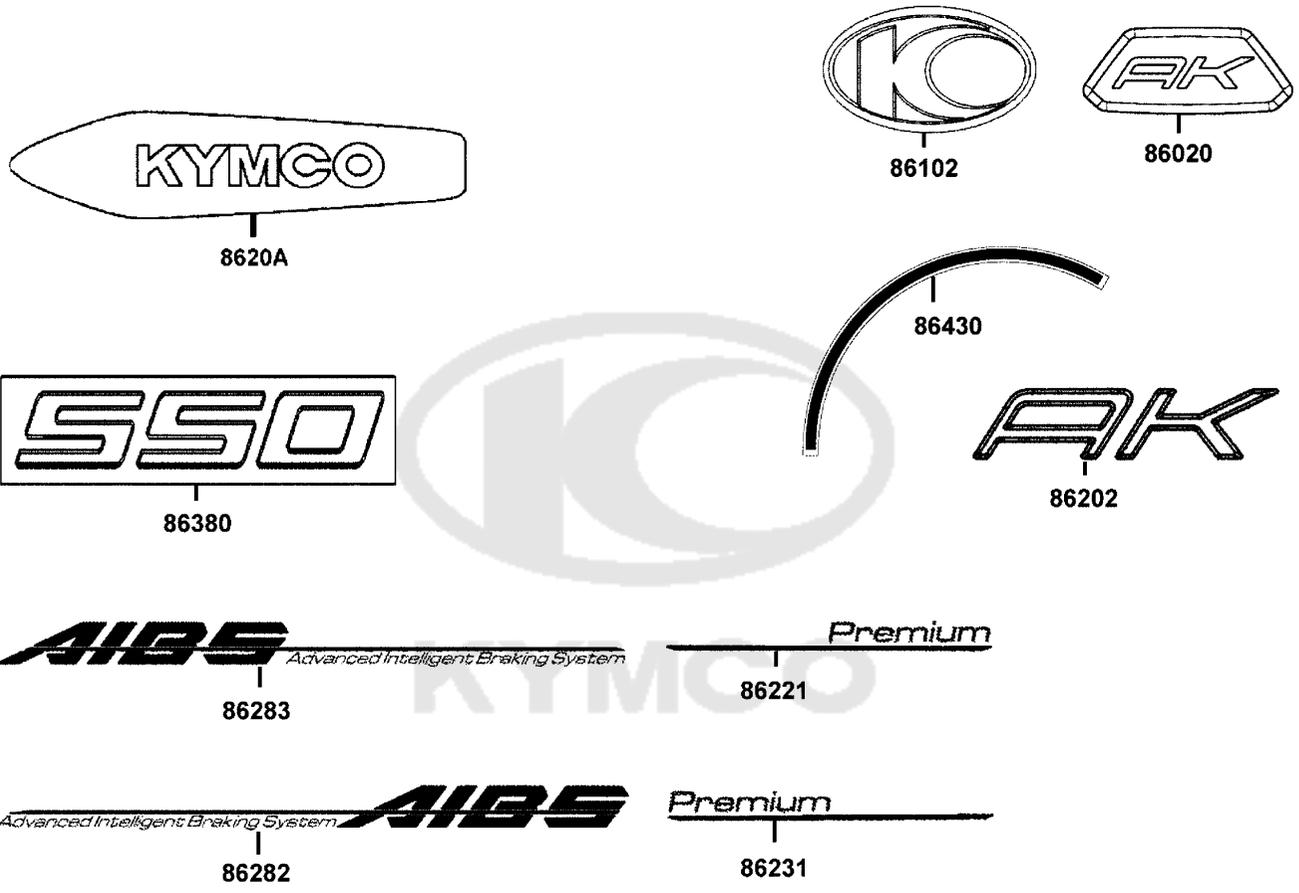

Sales mark	Ref no	Part no	Description	Reg description	Regd no	F26
**	86020	86020-AKB8-E00	EMB HANDLE COVER	EMB HANDLE COVER	1	
**	86102	86102-LGC6-E00	EMB K-LOGO	EMB K-LOGO	1	
**	86202	86202-AKB8-E00	EMB AK LOGO	EMB AK LOGO	1	
**	8620A	8620A-LGC6-E00	EMB KYMCO ASSY.	EMB KYMCO ASSY.	1	
**	86221	86221-AKB8-E01	STRIPE R PREMIUM BODY COVER	STRIPE R PREMIUM BODY COVER	1	
**	86231	86231-AKB8-E01	STRIPE L PREMIUM BODY COVER	STRIPE L PREMIUM BODY COVER	1	
**	86282	86282-AKB8-E00	STRIPE AIBS R FR MOLD	STRIPE AIBS R FR MOLD	1	
**	86283	86283-AKB8-E00	STRIPE L AIBS FR MOLD	STRIPE L AIBS FR MOLD	1	
**	86380	86380-LGC6-E00	EMB SIDE MOLD	EMB SIDE MOLD	1	
**	86430	86430-AKB8-E00	STRIPE WHEEL	STRIPE WHEEL	4	



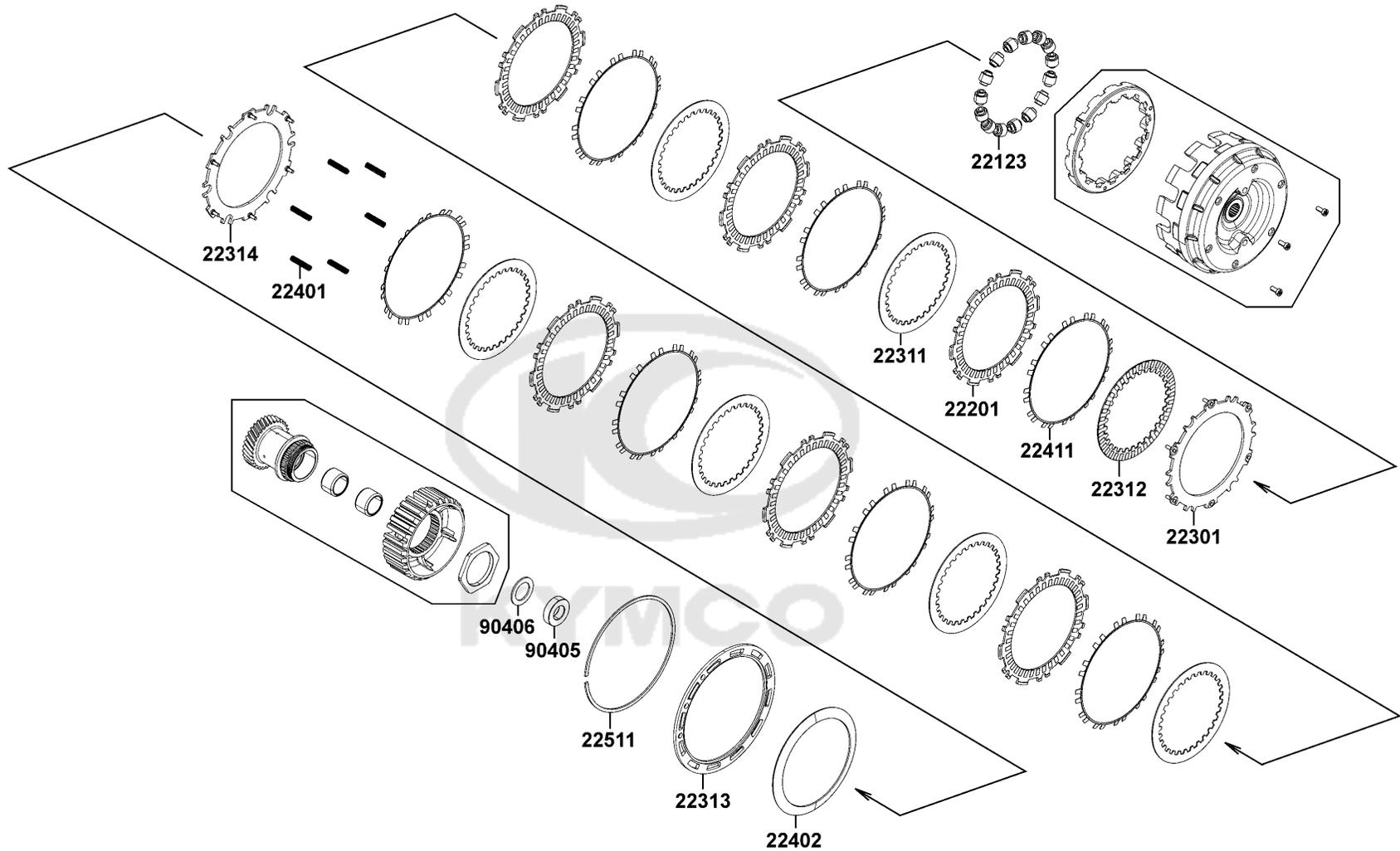

Sales mark	Ref no	Part no	Description	Reg description	Regd no	F27
	22123	22123-LGC6-305	ROLLER WEIGHT SET (1SET:15PCS)	ROLLER WEIGHT SET (1SET:15PCS)	1	
	22201	22201-LGC6-305	DISK SET CLUTCH FRICTION	DISK SET CLUTCH FRICTION (1SET:6PCS)	1	
	22301	22301-LGC6-E00	PLATE THRUST WEIGHT	PLATE THRUST WEIGHT	1	
	22311	22311-LGC6-305	PLATE SET CLUTCH FRICTION	PLATE SET CLUTCH FRICTION (1SET:5PCS)	1	
	22312	22312-LGC6-305	PLATE SET CLUTCH FRICTION	PLATE SET CLUTCH FRICTION (1SET:2PCS)	1	
	22313	22313-LGC6-E00-A	PRESSURE PLATE CLUTCH (zero HOLE	PRESSURE PLATE CLUTCH (zero HOLE TYPE)	1	
	22314	22314-LGC6-E00	PLATE SPRING STOPPER	PLATE SPRING STOPPER	1	
	22401	22401-LGC6-305	SPRING SET CLUTCH (1SET:6PCS)	SPRING SET CLUTCH (1SET:6PCS)	1	
	22402	22402-LGC6-E00	SPRING B CLUTCH	SPRING B CLUTCH	1	
	22411	22411-LGC6-305	SPRING A SET CLUTCH (1SET:7PCS)	SPRING A SET CLUTCH (1SET:7PCS)	1	
	22511	22511-LGC6-E00	CLIP CLUTCH	CLIP CLUTCH	1	
	90405	90405-LGC6-E00	COLLER CLUTCH	COLLER CLUTCH	1	
	90406	90406-LGC6-E00	WASHER 25X38X2	WASHER 25X38X2	1	

PART NO. INDEX

PART NO.	VERSION	PAGE	PART NO.	VERSION	PAGE	PART NO.	VERSION	PAGE
11000			12000			13221-LGC6-E00-D	3	E03
11108-LGC6-E00	1	F21	12100-LGC6-E00	6	E03	13221-LGC6-E00-E	3	E03
1110A-LGC6-E00	14	E01	12191-LGC6-E00	2	E03	13314-LGC6-E00-A	4	E09
11205-PSA6-E00	4	E10	12200-LGC6-305	0	E02	13314-LGC6-E00-B	4	E09
1121A-LGC6-E00	3	F14	12205-KHE8-310	1	E04	13314-LGC6-E00-C	4	E09
11300-LGC6-E00	5	E05	12205-LEA7-E00	0	E01	13314-LGC6-E00-D	4	E09
11302-LGC6-E00	3	E05	12208-LGC6-E00	0	E02	13314-LGC6-E00-E	4	E09
11305-LGC6-E00	3	E05	12209-LEA3-900	0	E02	13315-LGC6-E00-A	4	E09
11325-LGC6-E02	1	E10	12251-LGC6-E00	2	E02	13315-LGC6-E00-B	4	E09
1133A-LGC6-E00	3	E05	1231A-LGC6-E00	1	E02	13315-LGC6-E00-C	4	E09
11340-LGC6-305	0	E04	12391-LGC6-E00	0	E02	13315-LGC6-E00-D	4	E09
11347-LKF5-E00	1	E07				13315-LGC6-E00-E	4	E09
1134A-AKB8-305	1	E04	13000			13323-PRB9-E00-0A	3	E09
1134B-LGC6-E00	9	E05	1300A-LGC6-E00	9	E09	13323-PRB9-E00-0B	3	E09
11350-LGC6-E00	2	E05	13011-LGC6-E00	0	E03	13341-LGC6-E00	3	E04
11384-LEA7-E05	2	E02	13101-LGC6-E02	6	E03	13341-LGC6-E00	3	E10
11384-LGC6-E00	4	E04	13111-LGC6-E00	3	E03	1341A-LGC6-E00	5	E09
11384-LGC6-E02	0	E02	13210-LGC6-E00-1	3	E03	1342A-LGC6-E00	5	E09
11384-LGC6-E03	0	E03	13210-LGC6-E00-2	3	E03	14000		
11385-LGC6-E00	1	E08	13213-LGC6-E00	2	E03	14100-LGC6-E00	5	E02
11394-LGC6-E00	5	E05	13221-LGC6-E00-A	3	E03	14200-LGC6-E00	1	E02
11592-LGC6-E00	1	E01	13221-LGC6-E00-B	3	E03	14401-LGC6-E00	0	E03
11593-LGC6-E00	2	E01	13221-LGC6-E00-C	3	E03	14510-LGC6-E00	3	E03
11630-LGC6-E00	9	E05				14523-KKE5-E01	4	E03

PART NO. INDEX

PART NO.	VERSION	PAGE	PART NO.	VERSION	PAGE	PART NO.	VERSION	PAGE
14524-KKE5-E01	1	E03	14773-LGC6-E00-16	0	E02	1565A-AGJ5-E00	0	E10
1452A-ZPA3-E00	0	E03	14773-LGC6-E00-17	0	E02	15700-LGC6-E00	3	E01
14531-KHE7-900	1	E03	14773-LGC6-E00-18	0	E02	15772-5L00-013	1	F24
14546-LGC6-E00	1	E02	14773-LGC6-E00-19	0	E02			
14550-KKE5-E02	1	E03	14777-LGC6-E00	1	E02	16000		
14610-LGC6-E00	2	E03	14781-LGC6-C00	0	E02			
14711-LGC6-E00	1	E02				1610K-AKB8-E00	0	E06
14721-LGC6-E00	1	E02	15000			1611A-LGC6-E00	1	E06
14731-LGC6-E00	3	E02				16703-LHJ8-800	1	F10
14751-LGC6-E00	4	E02	15100-LGC6-E00	5	E08			
14771-LGC6-C00	0	E02	15133-LGC6-E00	1	E08	17000		
14773-LGC6-E00-01	0	E02	15141-GFY6-90C	1	E08			
14773-LGC6-E00-02	0	E02	15161-LGC6-E00	1	E01	1711A-AKB8-E00	2	E02
14773-LGC6-E00-03	0	E02	15161-LGC6-E00	1	E10	17126-AKB8-E00	0	E06
14773-LGC6-E00-04	0	E02	15162-LGC6-E01	0	E10	17206-LGC6-305	0	F14
14773-LGC6-E00-05	0	E02	15164-LGC6-E00	2	E01	17207-AKB8-E00	0	F14
14773-LGC6-E00-06	0	E02	1516A-LGC6-E00	0	E01	17211-LGC6-E00	1	F14
14773-LGC6-E00-07	0	E02	1516A-LGC6-E00	0	E10	17225-LGC6-E00	0	F14
14773-LGC6-E00-08	0	E02	15210-PUA5-E00	8	E01	17226-LGC6-E00	0	F14
14773-LGC6-E00-09	0	E02	15211-LGC6-E00	2	E01	17254-KACA-P00	0	F14
14773-LGC6-E00-10	0	E02	15214-PUA5-E00	8	E01	17292-PWB1-900	1	F14
14773-LGC6-E00-11	0	E02	15216-LGC6-E00	1	E01	17301-LEA7-M31	0	F24
14773-LGC6-E00-12	0	E02	15333-LEH6-E00	2	E08	17306-AKB8-E00	0	F24
14773-LGC6-E00-13	0	E02	15334-LEH6-E00	2	E08	17307-LGC6-E00	1	E06
14773-LGC6-E00-14	0	E02	1541A-LGC6-E00	0	E01	17308-LGC6-E00	1	F14
14773-LGC6-E00-15	0	E02	15421-PRA1-E00	5	E01	17310-LGC6-E01	0	F24

PART NO. INDEX

PART NO.	VERSION	PAGE	PART NO.	VERSION	PAGE	PART NO.	VERSION	PAGE
17359-4K19-671	0	F14	17686-AKB8-E00	0	F24	19014-LGC6-E00	2	F22
17359-LGC6-E00	0	F14	17691-AKB8-E00	0	F24	19015-LBA2-E00	0	F22
17371-1D74-671	0	F14	17693-LGC6-E00	0	F24	19016-LGC6-E00	1	F22
17460-AGA6-M01	0	F24	17810-LGC6-E00	3	E02	19018-LGC6-E00	1	F22
17500-LGC6-E00	3	F10	17910-AKB8-E00	0	F03	19019-LGC6-E00	3	F22
17511-LGC6-E00	1	F10	17911-AKB8-E00	0	F03	19020-LBA2-E00	0	F22
17512-LGC6-E00	1	F10				19025-LGC6-E00	2	F22
1752A-AKB8-E00	6	F10	18000			19026-LKF5-E00	0	F22
17530-KGB5-900	1	F10				19027-LKF5-E00	0	F22
17550-AKB8-E00	3	F10	18291-LKG2-90A	1	F15	19030-LDB5-E00	2	F22
17559-LGC6-E00	3	F10	18291-PWB1-900	4	F15	19101-AKB8-E00	0	F22
17561-LGC6-E00	3	F10	18293-LHJ8-900	2	F15	19104-ACD5-E00	0	F22
17561-LKB9-900	1	F10	18306-LGC6-E00	6	F15	19105-LGC6-E00	3	F22
17581-LGC6-E00	0	F10	1830A-LGC6-EY5	3	F15	19111-PRB3-900	2	F22
17583-LGC6-E00	0	F10	18310-LGC6-EY5	0	F15	19120-LGC6-E00	2	F22
17584-LGC6-E00	0	F10	18318-LGC6-E00	6	F15	19210-KKC4-900	0	F22
17585-LGC6-E00	0	F10	18319-LGC6-E00	6	F15	19215-AKB8-EA5	1	E04
17586-LGC6-E00	0	F10	1832A-LGC6-EZ5	0	F15	19217-AEE2-900	0	E04
17587-LGC6-E00	0	F10	18371-LBA2-E00	2	F15	19217-PRB9-E01	2	E04
17588-LGC6-E00	0	F10	18391-LKF5-E00	0	F15	19220-LGC6-E00	5	E04
17591-LGC6-E00	2	F10				19229-LGC6-E00	0	E04
17592-LGC6-E00	2	F10	19000			19230-LGC6-E00	4	E04
17620-LGC6-E00	3	F10				19231-AKB8-EA5	1	E04
17685-GLE0-301	2	E06	19010-LGC6-E00	0	F22	19317-LBA2-E00	1	E02
17685-KZCZ-900	0	F10	19012-LEA7-E05	1	F22	19319-LGC6-E00	0	E02
17685-LGC6-E00	3	F10	19013-LGC6-E00	1	F22	1931A-LGC6-E00	4	E02

PART NO. INDEX

PART NO.	VERSION	PAGE	PART NO.	VERSION	PAGE	PART NO.	VERSION	PAGE
19320-KED9-90A	1	E02	22301-LGC6-E00	5	F27			
19501-LGC6-E00	4	E03	22311-LGC6-305	0	F27	28000		
19502-LGC6-E00	4	E04	22312-LGC6-305	0	F27			
19504-LBA2-E00	3	E03	22313-LGC6-E00-A	4	F27	28102-LEA7-E00	3	E08
19504-LBA2-E00	3	E04	22314-LGC6-E00	5	F27	28110-LGC6-E01	4	E08
19505-LBA2-E00	4	F22	22401-LGC6-305	0	F27	28120-LGC6-E00	1	E08
19507-LDB5-E00	1	F22	22402-LGC6-E00	5	F27	28130-LGC6-E01	2	E08
21000			22411-LGC6-305	0	F27	30000		
			22511-LGC6-E00	2	F27			
21100-LGC6-E00	8	E05	23000			3051A-LGC6-E00	3	E02
21200-LGC6-306	0	E10						
21300-LGC6-305	0	E10	23010-LGC6-E00	9	E07	31000		
21395-LGC6-E00	5	E10	23100-LGC6-E00	2	E07			
22000			23200-LGC6-E00	3	E07	31110-LGC6-E00	1	E08
			23215-LGC6-E00	5	E05	31120-LGC6-E00	6	E08
			23220-LGC6-E00	7	E07	31129-LGC6-E00	3	E08
22102-LGC6-E00	1	E07	23225-LKF5-E00	4	E07	31210-LGC6-E00	1	E08
22105-LGC6-E00	4	E07	23233-LGC6-E00	0	E07	31340-LEA7-E00	3	F20
2210B-LGC6-E02	2	E05	23237-LGC6-E00	0	E07	31440-AKB8-E00	0	F12
22110-LGC6-E00	7	E07	23238-LDB5-E00	1	E07	31441-AKB8-E00	0	F12
22121-LGC6-305	0	E07	23420-LGC6-E00	1	E05	31445-AKB8-E00	0	F12
22123-LGC6-305	0	F27	23430-LGC6-E00	0	E05	31448-AKB8-E00	0	F12
22131-LGC6-E00	5	E07	23432-LGC6-E00	4	E05	31449-AKB8-E00	0	F12
22132-ADG5-305	0	E07	23800-AKB8-E00	0	F17	31600-ZXA6-M01	0	F20
22201-LGC6-305	0	F27				3195A-LBA7-E00	1	F20

PART NO. INDEX

PART NO.	VERSION	PAGE	PART NO.	VERSION	PAGE	PART NO.	VERSION	PAGE
32000			33731-LHJ8-900	2	F06			
			33734-LGC6-E00	2	F06	36000		
			33739-LGC6-E00	2	F06			
32100-AKB8-E01	9	F20	33741-ACH7-900	0	F19	3650A-LGC6-E00	5	F11
32101-LGC6-E00	5	E02	33900-LGC6-E00	4	F13			
32102-AKB8-E01	0	E08	34000			37000		
32103-AKB8-E01	0	F03						
32105-LLJ3-E00	2	E01				3720A-AKB8-E02	9	F02
32410-AKB8-E00	0	E08	34010-AKB8-E00	0	F20	37215-LGM9-900	0	F02
32411-AKB8-E00	0	F11	34019-AKB8-E00	0	F20	37215-LKG2-900	0	F03
32412-AKB8-E00	0	E08	35000			37800-AKB8-E00	0	F10
33000						38000		
			35101-AKB8-E00	0	F11			
33100-AKB8-305	0	F01	3515A-AKB8-E01	5	F03	38300-KKE5-E00	3	F03
33100-AKB8-E00	0	F01	3520A-AKB8-E01	8	F03	38500-LGL3-90A	5	F20
33107-AKB8-E00	0	F01	35230-AKB8-E00	0	F05	3855A-AKB8-E00	0	F11
33108-LGC6-E00	0	F01	35235-AKB8-E00	0	F05	38609-AKB8-E00	0	F20
33109-AKB8-E00	0	F01	35239-AKB8-E00	0	F05	3860A-ADG5-E00	0	F20
33111-LGC6-E00	0	F01	35240-AKB8-E01	0	F03	38620-LGC6-E00	3	F10
33130-AKB8-E00	0	F01	35340-AGJ5-E00	0	F04	38621-LGC6-E00	8	F10
33400-LGC6-E00	3	F18	35370-ZZA6-E00	0	F16	3862A-AKB8-E00	0	F21
33450-LGC6-E00	3	F18	35380-LEA2-900	2	F04	38700-AGJ5-305	0	F03
33700-LGC6-E00	6	F19	35390-LHG7-E00	5	F13	38703-AGJ5-E00	0	F03
33720-LGC6-305	0	F19	35500-LGC6-E00	2	E01	38704-AGE2-E00	4	F03
33727-LGC6-E00	0	F19	35850-KHB4-90A	5	F11	38705-AGJ5-E00	0	F03

PART NO. INDEX

PART NO.	VERSION	PAGE	PART NO.	VERSION	PAGE	PART NO.	VERSION	PAGE
38900-ACD5-E00	7	F05	40520-LGC6-E00	1	F17	43110-LGC6-E00	5	F08
39000			40521-LGC6-E00	1	F17	43113-LBA2-E00	0	F08
			40522-LGC6-E00	0	F17	43126-AKB8-E00	0	F04
			40530-AGJ5-E00	0	F08	43127-AKB8-E00	0	F04
			40543-LGC6-E00	2	F08	43128-AKB8-E00	0	E05
39100-LGC6-E00	0	F20	40553-LGC6-E00	2	F08	43156-AKB8-E00	0	E05
39208-AKB8-E01	0	F12	41000			43156-LGC6-E00	0	F08
39208-AKC3-EZ5	0	F12				43210-LGC6-305	0	F08
39209-AKB8-E00	0	F12				43351-LGC6-E01	3	F08
3920A-AKB8-E00	0	F12				43352-LGC6-E00	2	F08
39300-KKE5-800	2	E02	41201-AGJ5-E00	2	F08	4335A-LGC6-E00	0	F04
39310-KKE5-305	0	E02	41202-LGC6-E00	6	F08	43450-AKB8-E00	0	F03
39400-LEA6-800	2	E02	42000			43530-AGJ5-305	0	F04
39450-ZVA6-M00	1	F15				44000		
39500-AAC9-900	1	F14						
39550-AKB8-E00	0	F20		42301-LGC6-E00	3		F08	
39559-AKB8-E00	0	F20	42312-LGC6-E00	6	F08			
39600-ACH6-900	0	F10	42313-AKB8-E00	0	F08	44301-LGC6-E00	3	F07
39650-LGC6-E00	8	F11	42600-LGC6-305	0	F08	44312-LBA2-E00	2	F07
39660-LGC6-E00	5	F07	42620-LGC6-E00	0	F08	44600-LGC6-305	0	F07
39660-LGC6-E00	5	F08	42710-AKB8-E00	0	F08	44620-LGC6-E00	0	F07
40000			43000			44710-AKB8-E00	0	F07
						45000		
40510-LGC6-E00	5	F17	43100-LGC6-E01	7	F08			
40511-LGC6-E01	2	F17	43105-LGC6-305	0	F08	45100-LGC6-E00	0	F07
40512-LGC6-E00	0	F17	43109-LGC6-E00	3	F08	45105-LGC6-305	0	F07

PART NO. INDEX

PART NO.	VERSION	PAGE	PART NO.	VERSION	PAGE	PART NO.	VERSION	PAGE
45108-LGC6-305	0	F07				50325-AKB8-E01	0	F11
45126-AKB8-E00	0	F04	50000			50330-ALK5-900	2	F13
45127-AKB8-E00	0	F04				50330-LKF5-E00	1	F21
45129-AKB8-E00	0	F11	50127-AKB8-E00	0	F20	50500-AKB8-E00	0	F16
4512A-LGC6-E01	2	F07	50128-AKB8-E01	0	F11	50501-LGC6-E00	0	F16
45131-LDH1-E00	0	F08	5013A-AKB8-E00	0	F21	50502-GFY6-901	3	F16
45132-LDH1-E00	0	F08	50143-AKB8-E00	0	F22	50504-LGC6-E00	1	F17
45134-KED9-900	0	F08	50144-LGC6-E00	2	F22	50505-LEA7-E00	1	F16
45135-KED9-900	0	F08	50145-AKB8-E00	0	F21	50505-LKB9-900	1	F16
45156-AKB8-E00	0	F21	50146-AKB8-E00	0	F21	50506-KHE7-E00	0	F16
45156-AKB8-E00	0	F22	50149-LGC6-E00	1	F10	50530-LGC6-E00	6	F16
45200-LGC6-E00	0	F07	50150-LGC6-E00	12	F21	50531-LGC6-E00	2	F16
45209-LGC6-E00	3	F08	50158-AKB8-E01	2	F21	50532-AKB8-E00	0	F16
45352-LKF5-E00	2	F07	50176-AKB8-E00	0	F11	50550-KKC2-E00	0	F16
45513-AGJ5-E00	0	F04	50180-AKB8-E00	0	F21	50604-LGC6-E00	2	F07
45517-KFAF-900	0	F04	50181-AKB8-E00	0	F11	50611-LGC6-E00	1	F22
45520-KKA8-900	0	F04	50182-LGC6-E00	0	F22	50612-LGC6-E00	1	F22
45521-LEA7-E00	1	F04	50185-AKB8-E00	0	F21	50613-AKB8-E00	0	F22
45530-AKB8-305	0	F04	50186-AKB8-E00	0	F21	50615-LGC6-E00	1	F22
			50187-AKB8-E00	0	F11	50616-LGC6-E00	1	F22
49000			50189-LGC6-E00	4	F21	50617-LGC6-E00	5	F21
			50191-LGC6-E00	0	F21	50618-LGC6-E00	5	F21
49110-AKB8-E00	0	F04	50192-LGC6-E00	0	F21	50710-ACH6-900	3	F21
49200-AKB8-306	0	F04	50193-LGC6-E00	1	F21	50713-KEB7-900	0	F21
49211-LFH1-E00	1	F04	50194-LGC6-E00	0	F21	50715-KKAK-900	0	F21
			50306-AKB8-E00	0	F06	50719-LGC6-E00	3	F21

PART NO. INDEX

PART NO.	VERSION	PAGE	PART NO.	VERSION	PAGE	PART NO.	VERSION	PAGE
50720-ACH6-900	3	F21	52130-AKB8-E00	0	F17	53250-LEA7-90A	2	F06
51000			52133-LGC6-E00	6	F17	61000		
			52134-LGC6-E00	3	F17			
			52400-AKB8-E00	0	F17			
51400-LGC6-E00	9	F06	52415-LGC6-E00	0	F17	61100-LGC6-E00	5	F06
51421-LGC6-E00	4	F06	53000			61101-AKB8-E00	0	F06
51423-ADF8-E00	0	F23				61102-AKB8-E00	0	F06
51423-KED9-900	0	F23				61110-AKB8-E00	0	F05
51424-ADF8-E00	0	F23	53100-AKB8-E00	0	F03	64000		
51424-KED9-900	0	F23	53105-LGC6-E00	2	F03			
51427-ADF8-E00	0	F23	53109-LGC6-E00	0	F03			
51427-LGC6-E00	0	F23	53165-LGC6-E01	5	F03	64140-AKB8-E00	0	F03
51427-LGC6-E02	0	F23	53166-LGC6-E01	7	F03	64150-AKB8-E00	0	F03
51428-KED9-900	0	F23	53175-AGJ5-E00	0	F04	64202-AKB8-E00	0	F05
51430-ACD5-E00	0	F08	53178-AGJ5-E00	0	F04	64203-AKB8-E00	0	F05
51430-LGC6-C00	0	F23	53200-AKB8-E00	0	F06	64206-MLJ0-001	1	F03
51431-KED9-900	0	F23	53203-AKB8-E00	6	F03	64206-MLJ0-001	1	F17
51431-LGC6-E00	0	F23	53204-AKB8-E00	0	F03	64222-LLJ3-E00	1	F03
51432-LGC6-E00	0	F23	53205-AKB8-E00	0	F03	64222-LLJ3-E00	1	F06
51500-LGC6-E00	6	F06	53206-AKB8-E00	0	F03	6422A-AKB8-E00	0	F03
51521-LGC6-E00	4	F06	53207-AKB8-E00	7	F03	64240-AKB8-E00	0	F03
52000			53213-AKB8-E00	0	F06	64250-AKB8-E00	0	F03
			53214-LBA2-E00	2	F06	64301-AKB8-E00	0	F05
			53220-AKB8-E00	0	F06	64302-AKB8-E00	0	F05
52100-AKB8-E00	0	F17	5323A-AKB8-E00	0	F06	64303-AKB8-E00	0	F05
52120-AKB8-E00	0	F17	53240-AKB8-E00	0	F06	64305-AKB8-E00	0	F05

PART NO. INDEX

PART NO.	VERSION	PAGE	PART NO.	VERSION	PAGE	PART NO.	VERSION	PAGE
64306-AKB8-E00	0	F05	6435B-AKB8-E00	0	F12	80151-AKB8-E00	0	F05
64310-AKB8-E00	0	F05	64360-AKB8-E00	0	F05	80152-AKB8-E00	7	F13
64311-AKB8-E00	0	F05	64370-AKB8-E00	0	F05	80154-AKB8-E00	8	F13
64312-AKB8-E00	0	F05	64380-AKB8-E00	0	F05	80155-AKB8-E00	1	F10
64313-AKB8-E00	0	F05	64400-AKB8-E00	0	F05	80161-AKB8-E00	0	F05
64316-AKB8-E00	0	F12						
64317-AKB8-E00	0	F21	77000			81000		
64319-AKB8-E00	0	F12						
64320-AKB8-E00	0	F05	77200-AKB8-309	0	F09	81122-AKB8-E00	4	F05
64323-AKB8-E00	0	F12	77206-KGBG-900	1	F09	81123-AKB8-E00	0	F05
64330-AKB8-E00	0	F05	77210-AKB8-E00	0	F09	81124-AKB8-E00	0	F05
64331-AKB8-E00	0	F12	77235-LGC6-E00	4	F10	81125-AKB8-E00	0	F05
64332-AKB8-E00	0	F12	77240-AKB8-E00	0	F10	81131-AKB8-E00	0	F03
64333-AKB8-E00	0	F12	77241-LGC6-E00	8	F10	81132-AKB8-E00	5	F05
64334-AKB8-E00	0	F12	77300-AKB8-E00	0	F09	81136-AKB8-E00	0	F05
64335-AKB8-E00	0	F12	77303-LHJ8-900	1	F09	81137-AKB8-E00	0	F05
64336-AKB8-E00	0	F12	7731A-AKB8-E00	0	F09	81137-LGC6-E00	4	F13
64338-AKB8-E00	0	F12				81138-AKB8-E00	0	F05
64340-AKB8-E00	0	F05	80000			81138-LGC6-E00	2	F10
64341-AKB8-E00	0	F12				81139-AKB8-E00	0	F05
64342-AKB8-E00	0	F12	80100-LGC6-E00	3	F19	81141-AKB8-E00	6	F05
64343-AKB8-E00	0	F12	80101-AKB8-E00	5	F19	81142-AKB8-E00	0	F03
64350-AKB8-E00	0	F05	80105-AKB8-E00	0	F19	81143-AKB8-E00	0	F05
64355-AKB8-E00	3	F12	80106-AKB8-E00	0	F19	81200-AKB8-E00	3	F13
64357-AKB8-E00	0	F12	80116-AEG9-900	2	F19	81255-LGC6-E00	0	F13
6435A-AKB8-E00	0	F12	80143-LGC6-E00	0	F10	81260-AKB8-E00	0	F13

PART NO. INDEX

PART NO.	VERSION	PAGE	PART NO.	VERSION	PAGE	PART NO.	VERSION	PAGE
83000			86102-LGC6-E00	5	F26	90000		
83500-AKB8-E00	0	F13	86202-AKB8-E00	0	F26	90001-GBHB-661	3	E08
83501-AKB8-E00	0	F13	8620A-LGC6-E00	3	F26	90001-GBHB-661	3	F21
83502-AKB8-E00	0	F13	86221-AKB8-E01	3	F26	90004-LGC6-E00	1	E05
83510-AKB8-E00	0	F05	86231-AKB8-E01	3	F26	90005-LEH6-E00	3	E03
83520-AKB8-E00	5	F05	86282-AKB8-E00	4	F26	90007-LGC6-E00	0	E02
83530-AKB8-E00	0	F13	86283-AKB8-E00	4	F26	90010-KKE5-E01	4	E10
83540-AKB8-E00	7	F13	86380-LGC6-E00	2	F26	90018-KKE5-E00	2	E02
83550-AKB8-E00	7	F13	86430-AKB8-E00	0	F26	90027-PUA5-E00	9	E02
83550-KEC8-900	4	F06	87000			90033-KGB4-C00	2	E02
83551-KEC8-900	4	F06	87515-LGC6-E00	2	F25	90033-LGC6-E00	0	E01
83600-AKB8-E00	0	F13	87541-ZZA6-E00	2	F25	90084-4H28-001	1	E04
83601-AKB8-E00	0	F13	87546-ADG5-E00	2	F13	90084-KKE5-E00	5	E05
83602-AKB8-E00	0	F13	87546-ADG5-E00	2	F25	90084-KKE5-E00	5	E10
83610-AKB8-E00	0	F05	87560-LGC6-E00	2	F25	90085-KKE5-E00	3	E02
83620-AKB8-E00	5	F05	88000			90101-KGC4-E00	1	F09
83630-AKB8-E00	0	F13	88110-AKB8-E00	0	F03	90101-LEA7-E00	1	F15
83640-AKB8-E00	7	F13	88120-AKB8-E00	0	F03	90101-LGC6-E00	1	F17
83650-AKB8-E00	7	F13	89000			90102-LGC6-E00	0	F17
83750-AKB8-E00	0	F13	89010-LGC6-E00	2	F09	90105-KCR3-001	1	F07
86000						90105-KCR3-001	1	F08
86020-AKB8-E00	0	F26				90105-KFC2-900	0	F03
						90106-LEC8-900	1	F13
						90107-LEA7-E00	4	F06

PART NO. INDEX

PART NO.	VERSION	PAGE	PART NO.	VERSION	PAGE	PART NO.	VERSION	PAGE
90108-LGC6-E00	3	F16	90302-LLB1-E00	2	F10	90318-PWB1-900	0	E05
90110-KED9-900	2	F17	90302-SDA4-004	3	F03	90319-PWB1-900	0	E05
90111-LEB1-900	1	F19	90302-SDA4-004	3	F05	90320-PWB1-900	0	E05
90111-LGC6-E01	1	F03	90302-SDA4-004	3	F13	90321-PWB1-900	0	E05
90111-LGC6-E01	1	F13	90302-SDA4-004	3	F19	90322-PWB1-900	3	E05
90111-LGE3-910	0	F01	90304-AKB8-E00	0	F06	90323-PWB1-900	0	E05
90111-LGE3-910	0	F02	90304-LEA1-900	1	F03	90324-PWB1-900	0	E05
90113-LGE5-E01	0	F04	90304-LEA1-900	1	F11	90401-KKJ9-001	0	E09
90121-LGC6-E00	0	F16	90304-LEA1-900	1	F16	90403-AKB8-E00	0	F06
90122-LKF5-E00	1	F07	90304-LEA1-900	1	F17	90403-LGC6-E00	1	E05
90123-LGC6-E00	0	F16	90304-LEA1-900	1	F21	90405-LGC6-E00	4	F27
90125-AKB8-E00	0	F11	90304-LGC6-E00	1	F15	90406-LGC6-E00	3	F27
90145-LEA3-E00	1	F04	90305-KNBN-90B	1	F17	90412-3K29-001	0	E08
90145-LFH1-E00	1	F04	90305-LBA2-E00	1	F06	90412-PUA5-E00	4	E01
90201-KHR8-75A	1	E09	90306-LBA2-900	1	F08	90441-LKF5-E00	0	E05
90201-LGC6-E00	2	F17	90306-LFE2-900	1	F21	90442-LGC6-E00	1	E01
90202-LDB5-E00	3	E07	90309-GLW0-90A	1	F17	90452-LBA7-900	1	E05
90204-LGC6-E00	0	E05	90311-PWB1-900	0	E05	90459-LKF5-E00	0	E04
90215-KKC4-900	2	F11	90312-LLJ3-E00	1	F03	90463-PUA5-E00	4	E10
90301-6D34-671	1	F10	90312-LLJ3-E00	1	F06	90465-PUA5-E00	5	E01
90301-6D34-671	1	F19	90312-PWB1-900	0	E05	90478-7L00-001	0	E02
90301-6D34-671	1	F22	90313-PWB1-900	0	E05	90478-7L00-001	0	E04
90301-GFY6-901	2	F15	90314-PWB1-900	0	E05	90501-KNBN-901	0	F17
90302-GFY6-940	2	F04	90315-PWB1-900	0	E05	90501-LEH6-E00	0	E03
90302-GFY6-940	2	F10	90316-PWB1-900	0	E05	90503-0A51-870	0	F17
90302-LLB1-E00	2	F05	90317-PWB1-900	0	E05	90503-AKB8-E00	0	F06

PART NO. INDEX

PART NO.	VERSION	PAGE	PART NO.	VERSION	PAGE	PART NO.	VERSION	PAGE
90525-KED9-900	2	E01	90805-LGC6-E00	3	E01	91305-LEH6-E00	0	E03
90525-KED9-900	2	E03	90807-PRA1-E00	3	E02	91305-LEH6-E00	0	E10
90541-PUA5-E00	4	E02				91306-PUA5-E00	3	E01
90544-KEC8-900	0	F23	91000			91306-PUA5-E00	3	E10
90545-3L00-001	2	F04				91307-0E35-001	1	E10
90651-LEA2-900	0	F20	91201-LGC6-E00	1	E05	91308-LGC6-E00	3	E01
90652-GFY6-910	1	E02	91201-LKF5-E00	1	E09	91311-PRA1-E00	3	E01
90652-KHE7-900	0	F14	91202-LGC6-E00	3	E05	91316-PRA1-E00	3	E01
90652-LCA4-E00	6	F01	91202-LKG2-900	1	E04	91351-LDB5-E00	1	E07
90652-LCA4-E00	6	F03	91205-LGC6-E00	1	E05	91507-LEA7-E00	1	E05
90652-LCA4-E00	6	F05	91211-LGC6-E00	0	E07	91507-LKE6-900	1	F20
90652-LCA4-E00	6	F19	91252-LGC6-E00	2	E10	91552-LEH6-E00	0	E03
90652-LFB5-900	3	F03	91252-LGC6-E00	2	F17	91552-LGC6-E00	0	E01
90652-LFB5-900	3	F05	91254-LGC6-E00	1	F08	91552-LGC6-E00	0	E05
90652-LFB5-900	3	F13	91257-KED9-900	2	F07			
90652-LGC6-E00	0	F03	91257-LGC6-E00	0	F17	92000		
90653-LGC6-E00	3	F05	91301-LGC6-E00	2	E01			
90656-KCBC-900	0	F03	91301-LGC6-E00	2	E05	92000-05016-0G	0	E08
90656-KCBC-900	0	F19	91302-KKE5-800	1	E02	92101-LGC6-E00	2	F17
90656-KUDU-900	0	F20	91302-LDB2-E00	1	E02			
90656-ZVA6-M00	0	F20	91302-PRA1-E00	3	E01	93000		
90660-LDE9-E00	1	F20	91303-3G77-001	0	E04			
90660-LGC6-E00	0	F14	91303-PUA5-E00	3	E08	93401-06020-07	0	F16
90660-PWA2-900	1	F03	91304-LFA7-E00	3	E01	93404-06012-06	1	F03
90660-PWA2-900	1	F24	91304-LGC6-E00	4	E05	93404-06012-06	1	F05
90662-LHG7-E00	1	F22	91305-LEH6-E00	0	E01	93404-06012-06	1	F11

PART NO. INDEX

PART NO.	VERSION	PAGE	PART NO.	VERSION	PAGE	PART NO.	VERSION	PAGE
93404-06012-06	1	F12	93903-GFY6-900	1	F05	94101-06000	0	F21
93404-06012-06	1	F13	93903-GFY6-900	1	F13	94101-06200	1	F15
93404-06012-06	1	F17	93903-GFY6-900	1	F19	94101-08600	0	F16
93404-06012-06	1	F19	93903-LGC6-E01	0	F03	94101-10000	0	F03
93404-06012-06	1	F22	93903-LGC6-E01	0	F05	94101-10000	0	F16
93404-06016-06	1	F22	93903-LHJ8-910	1	F02	94101-12000	0	F03
93404-06025-06	0	F22				94101-LDB5-E00	0	F15
93404-LLF5-910	0	F20	94000			94101-LEA2-900	0	F15
93500-05010-0F	0	F03				94101-LGC6-E00	0	F08
93500-05012-0HG	0	F12	94001-06080-0SG	0	F12	94102-08000	5	F03
93500-LGC6-E00	0	F10	94001-LGC6-E00	0	E07	94102-LGC6-E00	3	E04
93600-04012-1G	0	F04	94050-06060	1	E05	94103-06600	0	F12
93893-04012-18	0	F04	94050-06060	1	F04	94111-06800	0	E02
93903-24360	0	F02	94050-06060	1	F06	94111-ACD5-E00	1	F15
93903-24360	0	F03	94050-06060	1	F09	94201-20120	0	F21
93903-24360	0	F05	94050-06060	1	F11	94201-20180	0	F16
93903-24360	0	F06	94050-06060	1	F12	94301-08140	4	E01
93903-24360	0	F13	94050-06060	1	F20	94301-08140	4	E02
93903-24360	0	F17	94050-06060	1	F21	94301-08140	4	E05
93903-24360	0	F19	94050-06080	2	F09	94301-08140	4	E10
93903-24360	0	F22	94050-08020	0	F17	94301-10200	2	E05
93903-25460	1	F14	94050-08060	0	F20	94301-12200	1	E02
93903-34360	0	F14	94050-10060	0	E01	94301-12200	1	F17
93903-35260	0	F01	94050-LHJ3-900	0	F19	94302-10160	0	F16
93903-35260	0	F18	94050-LKF5-E00	1	E07	94510-10000	0	E08
93903-GFY6-900	1	F03	94101-04800	0	F10	94510-12000	0	E04

PART NO. INDEX

PART NO.	VERSION	PAGE	PART NO.	VERSION	PAGE	PART NO.	VERSION	PAGE
94510-25000	0	E05	95014-72204	0	F16	95701-08035-06	1	F09
94520-32180	0	E04	95014-PRB3-900	0	F20	95701-AKB8-E00	0	F11
94520-32180	0	E10	95701-06012-06	1	F03	95709-PRA1-E00	4	E05
94520-42000	2	E05	95701-06012-06	1	F10	95801-08090-06	0	E01
94540-03029	0	F05	95701-06012-06	1	F12	95801-08090-06	0	F17
94591-27000	0	F13	95701-06012-06	1	F20	95801-10030-06	0	F08
94591-KFBF-900	2	F22	95701-06012-06	1	F21	95801-10030-06	0	F16
94591-LEA7-E01	2	F20	95701-06012-06	1	F22	95801-10055-06	0	F21
94591-LLB1-900	0	F20	95701-06016-06	1	F11	95801-10060-06	0	F17
94601-17000	0	E03	95701-06020-06	1	F03	95801-10065-06	0	F16
94605-LGC6-E00	0	F23	95701-06020-06	1	F04	95801-10065-06	0	F21
			95701-06020-06	1	F12	95801-10120-06	0	F17
95000			95701-06020-06	1	F14	95801-12295-06	1	F21
			95701-06035-08G	1	F12	95801-LEA1-900	1	F08
95002-02070	2	E06	95701-06040-06	0	F06			
95002-02070	2	F24	95701-08012-06	0	F21	96000		
95002-02080	0	F10	95701-08016-06	0	F06			
95002-02080	0	F24	95701-08016-06	0	F10	96001-06010-06	0	E04
95002-02110	0	F14	95701-08016-06	0	F11	96001-06012-06	0	E05
95002-41100-08	0	F14	95701-08016-06	0	F20	96001-06012-06	0	F08
95002-41250-00	0	F14	95701-08016-06	0	F21	96001-06012-06	0	F20
95002-KED9-M30	1	F14	95701-08020-06	1	F03	96001-06014-06	0	E05
95002-LHG8-E00	1	F14	95701-08020-06	1	F21	96001-06016-08G	1	F12
95002-LKF5-E00	2	F14	95701-08025-06	0	E05	96001-06018-06	0	E02
95003-23004-60	0	F14	95701-08025-06	0	F21	96001-06018-06	0	F14
95012-KED9-900	1	F11	95701-08025-06	0	F22	96001-06022-06	1	F04

PART NO. INDEX

PART NO.	VERSION	PAGE	PART NO.	VERSION	PAGE	PART NO.	VERSION	PAGE
96001-06022-06	1	F16	96052-PRA1-E00	0	F08	96700-LGC6-E00	1	F17
96001-06028-06	0	E03	96100-30203-10	0	E05	96700-LGC6-S00	0	F17
96001-06035-06	0	E01	96100-60010-00	0	E04	96701-LGC6-E01	0	F15
96001-06035-06	0	E08	96100-60060-00	0	E10			
96001-06055-06	0	E01	96100-62010-00	0	E04	98000		
96001-06065-06	0	F04	96100-62050-00	2	E05			
96001-06090-06	2	E01	96100-62050-00	2	E10	98059-57916-00	2	E02
96001-06130-06	1	E02	96100-62060-00	2	E05	98200-40500	0	F11
96001-LAB4-900	3	F14	96100-63020-00	0	E05	98200-40750	0	F11
96005-PRA1-E00	2	E01	96100-63040-00	1	E05			
96005-PRA1-E00	2	E02	96100-LGC6-E00	0	F17	502000		
96008-PRA1-E00	2	E02	96140-62010	0	E10			
96008-PRA1-E00	2	E04	96150-60040-10	0	F07	502-00149	0	F20
96011-PRA1-E00	2	E10	96150-60060-10	0	E05	502-00151	0	F20
96012-PRA1-E00	2	E05	96150-62060-10	0	F17	502-00155	0	F20
96013-LGC6-E00	0	E04	96150-LGC6-E00	0	F08	502-00164	0	F20
96013-LGC6-E00	0	E08	96211-08000	19	F21			
96014-PRA1-E00	2	E02	96211-16000	2	E01			
96015-PRA1-E00	2	E04	96220-40158	1	E08			
96018-PRA1-E00	2	E05	96600-06015-10	4	E08			
96023-PRA1-E00	0	E02	96600-08025-06	0	F06			
96023-PRA1-E00	0	E05	96600-08035-06	0	F06			
96023-PRB9-E00	0	E04	96600-LEA7-E01	1	F15			
96026-PRA1-E00	0	E05	96600-LKF5-E00	0	F23			
96033-PRA1-E00	2	E05	96700-06020-06	0	F17			
96052-PRA1-E00	0	F07	96700-KED9-900	3	F06			