

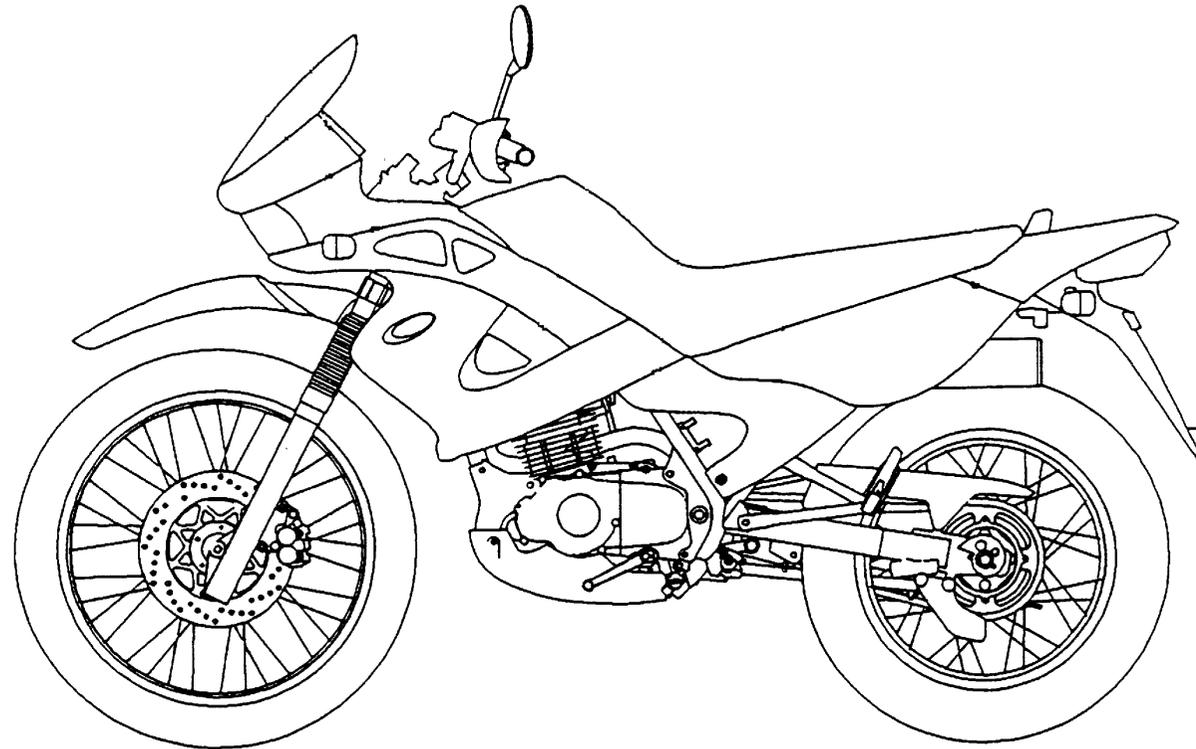

# 零件型錄

## PARTS CATALOGUE

DA25BD(GM) : FEB/21/2004 制定



光陽機車

KYMCO

光陽機車

KYMCO

光陽機車

KYMCO

## 前 言

- 本零件目錄適用於 DA25BD(GM) 機種，訂購零件時，請參照本冊。
- 本冊之配色表僅供參考，若與實車不符之處，以實車為準。
- 販賣記號(Sales mark)：
  - 1、註明 ★★ 記號，表示訂購該零件時，請參照機車相片及配色表，並請在基本零件號碼最後加上色碼。
- 本冊付梓印刷倉促，倘有錯誤或遺漏之處，敬請不吝賜教指正。

## ABOUT THIS PARTS LIST

- This parts list is compiled all service parts for model DA25BD(GM)。
- Any difference between color chart and motorcycle will be revised according to motorcycle。
- The sales mark：
  - 1、marking "★★" must add color code in the end before ordering parts。
  - When modification or additions to this parts list are made a revised edition at an appropriate time。

## 目 次

●前 言 .....	1
●DA25BD(GM)配色表.....	5
●引擎分組圖 .....	7
●車架分組圖 .....	9
●引擎零件號碼表.....	13
●車架零件號碼表.....	53
●零件號碼索引 .....	133

## CONTENTS

●ABOUT THIS PARTS LIST.....	1
●COLOR CHART OF DA25BD(GM) .....	5
●CONTENTS-ENGINE GROUP .....	7
●CONTENTS-FRAME GROUP .....	9
●ENGINE PARTS LIST .....	13
●FRAME PARTS LIST.....	53
●PART NO. INDEX.....	133

項次 NO	機種名稱 (MODEL)			DA25BD(GM) COLOR CHART		
	相片號碼 (PHOTO NO)			NO.1	NO.2	NO.3
	主體色 (BASIC COLOR)			黃	藍	亮紅
	色碼 (CODE)			Yellow	Blue Metallic	Bright Red
	色別零件名稱(PARTS NAME)	基本零件號碼(PARTS NO)	版數(VERSION)	YR108SA	PB023MA	RR136PA
1	COVER UPPER FR	64301-KEC8-900	0	Y5P	B4P	R9P
2	FENDER FR	61110-KEC8-800	0	N8P		
3	COVER R SIDE	64304-KEC8-900	0	Y5P	N8P	N8P
4	COVER L SIDE	64305-KEC8-900	0			
5	COVER R BODY A	83500-KEC8-900	0			
6	COVER L BODY A	83600-KEC8-900	0			
7	COVER B SET R BODY	83510-LLE2-305	0			
8	COVER B SET L BODY	83610-LLE2-305	0	N8P	B4P	N8P
9	COVER R FR	64302-KEC8-900	0	PAR	N1R	N1R
10	COVER L FR	64303-KEC8-900	0			
11	COVER UNDER	50613-KEC8-900	0			
12	COWL SET R UNDER	77115-LLE2-305	0			
13	COWL SET L UNDER	77116-LLE2-305	0	N8P	B4P	R9P
14	CARRIER RR	81200-KEC8-900	0			
15	LID RR CARRIER	81210-KEC8-900	0			
16	PROTECTOR R HANDLE	53227-KEC8-800	0	N1R		
17	PROTECTOR L HANDLE	53237-KEC8-800	0			
18	CALIPER ASSY FR	45200-KEC8-900	0	NGA		
19	CUSHION ASSY REAR	52400-KEC8-900	0	N1S		
20	LEVER R STRG HANDLE	53175-KAK-900	3	NJA		
21	LEVER L STRG HANDLE	53178-KEC8-900	1			
22	COCVER COMP R CRANK CASE	11330-KEC2-900	1			
23	COVER L CRANK CASE	11341-KEC2-900	4			
24	SEAT ASSY	77200-KEC8-900	0	T02	T01	T01
25	STRIPE R COWL	86103-LLE2-E70	0	T01	T02	T03
26	STRIPE L COWL	86133-LLE2-E70	0			
27						
28						
29						
30						
31						
32						
33						
34						
35						
36						
37						
38						
39						
40						
41						
生產日期 (DATE OF STARTING-SALES)					2003.11.11	
停產日期 (DATE OF ENDING-SALES)						













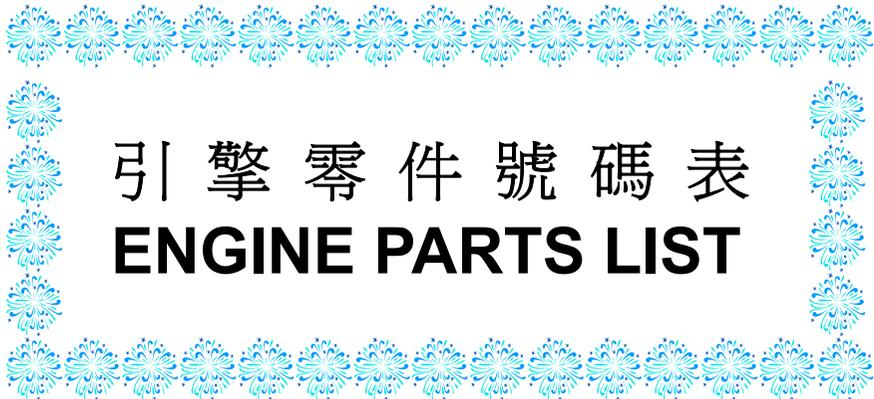

引擎零件號碼表  
**ENGINE PARTS LIST**

**E 1** Cylinder●Cylinder Head

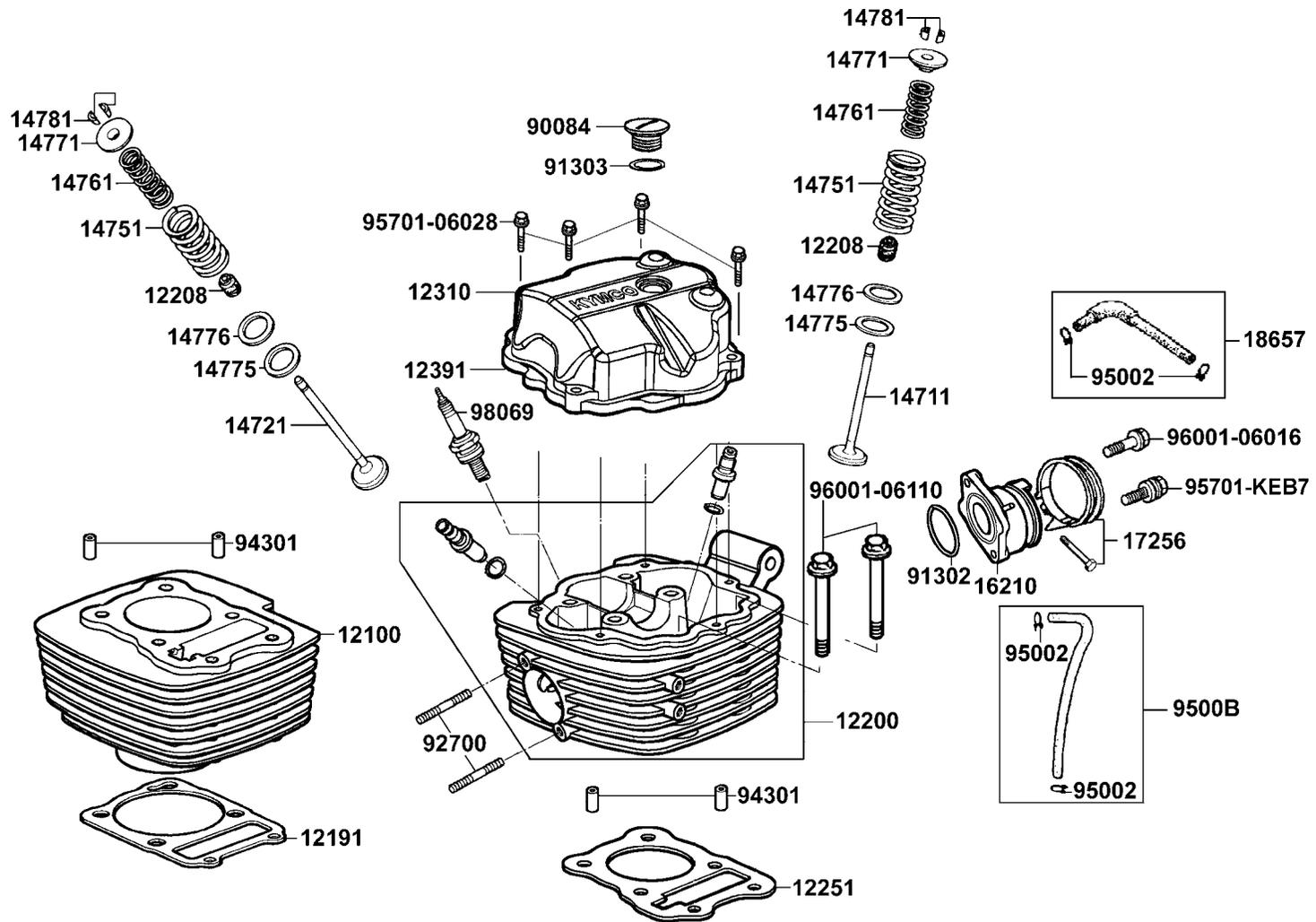

販賣記號	項目	零件號碼	版數	英文名稱	中文名稱	需要用量	參考價
Sales mark	Ref no	Part no	Ver	Description	Chinese	Regd no	Ref Price
		12100-KKA7-9000	3	CYLINDER COMP	汽缸	1	
		12191-KEC8-9000	0	GASKET CYLINDER	汽缸墊片	1	
		12200-KHC6-900	0	HEAD COMP CYLINDER	汽缸頭	1	
		12208-413-0040	0	SEAL VALVE STEM	門閥徑封	2	
		12251-KEC8-9000	0	GASKET CYLINDER HEAD	汽缸頭墊片	1	
		12310-KHC6-C10	2	COVER CYLINDER HEAD	汽缸頭蓋	1	
		12391-KEC8-9000	0	PACKING CYLINDER HEAD	汽缸頭墊片	1	
		14711-383-0000	0	VALVE INLET	進氣閥	1	
		14721-383-0000	0	VALVE EXHAUST	排氣閥	1	
		14751-KEC8-9000	0	SPRING VALVE OUTER	閥門外彈簧	2	
		14761-KEC8-9000	0	SPRING VALVE INNER	閥門內彈簧	2	
		14771-107-0210	0	RETAINER VLV SPG	門閥彈簧扣環	2	
		14775-107-0000	1	SEAT VALVE SPRING OUTER	閥門彈簧座	2	
		14776-107-0100	1	SEAT VALVE SPRING INNER	汽門座內彈簧	2	
		14781-107-021	2	COTTER VALVE	閥門鎖扣	4	
		16210-KEC8-8000	0	INSULATOR CARB COMP	汽化器絕緣管	1	
		17256-KKC5-E000	0	BAND INSULATOR	束帶	1	
		18657-KEC8-900	0	TUBE ASSY AICV-INLET PIPE	AICV 負壓管組	1	
		90084-428-0010	0	CAP ACG	A. C. G. 蓋	1	
		91302-200-0010	0	O-RING 33.5*3	O環 33.5*3	1	

E 1

**E 1** Cylinder●Cylinder Head

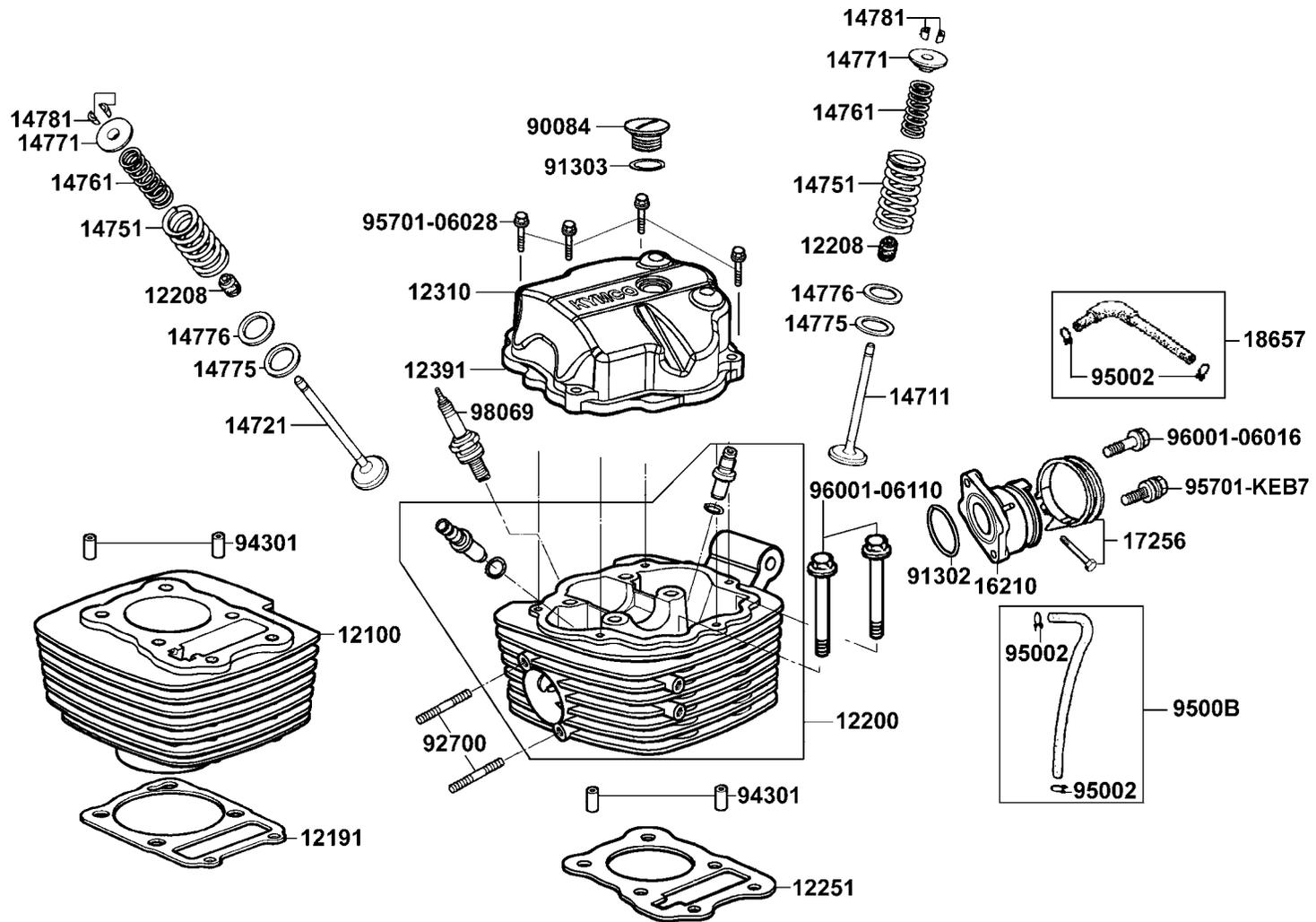

販賣記號	項目	零件號碼	版數	英文名稱	中文名稱	需要用量	參考價
Sales mark	Ref no	Part no	Ver	Description	Chinese	Regd no	Ref Price
		91303-377-0010	0	O-RING 13.8*2.5	O環 13.8*2.5	1	
		92700-06035-3E	0	BOLT STUD II 6*35	雙頭螺絲 6*35	2	
		94301-10160	0	DOWEL PIN 10*16	定位銷	4	
		95002-02070	0	CLIP B7 TUBE	管夾	4	
		9500B-KEC8-9000	0	TUBE ASSY COCK-INLET PIPE	油管組	1	
		95701-06028-08	0	BOLT FLANGE 6*28	螺絲 6*28	4	
		95701-KEB7-E000	1	BOLT TORQUE 6*16	螺絲 6*16	1	
		96001-06016-08	0	BOLT FLANGE SH 6*16	螺絲 6*16	1	
		96001-06110-08	0	BOLT FLANGE SH 6*110	螺絲 6*110	2	
		98069-5771R	0	SPARK PLUG (DR-8EA)	火星塞	1	

E 1

**E 2 Cam Shaft Comp**

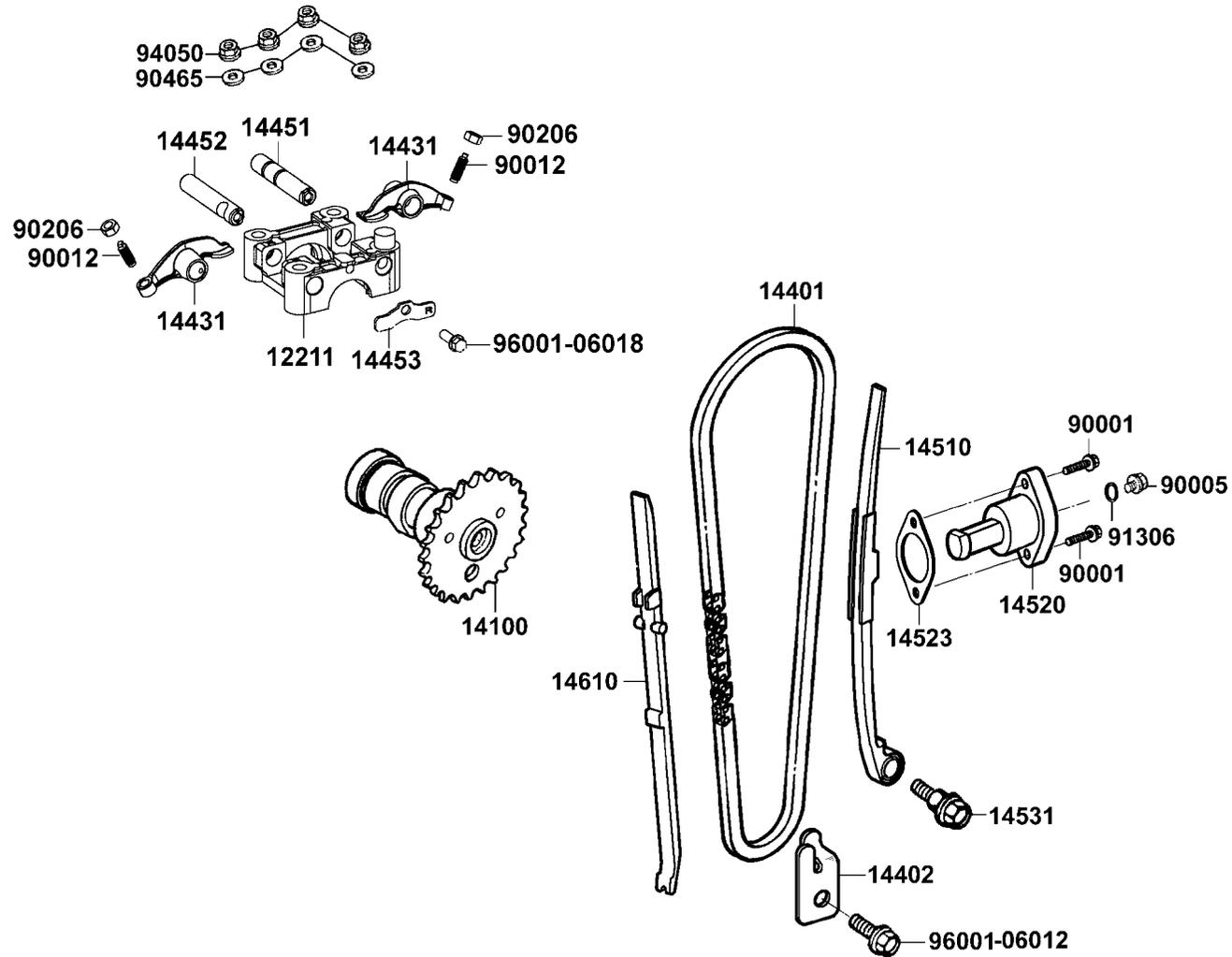

販賣記號	項目	零件號碼	版數	英文名稱	中文名稱	需要用量	參考價
Sales mark	Ref no	Part no	Ver	Description	Chinese	Regd no	Ref Price
		12211-KEC8-9000	1	HOLDER CAM SHAFT	凸輪軸固定座	1	
		14100-KEC8-220	0	SHAFT COMP CAM	凸輪軸	1	
		14401-KEC8-9000-M1	0	CHAIN CAM	內鏈條	1	
		14402-KEC8-9000	0	PLATE SET CAM CHAIN	鏈條固定座	1	
		14431-KEC8-9000	1	ARM VALVE ROCKER	門閥搖臂	2	
		14451-KEC8-9000	1	SHAFT IN ROCKER ARM	進汽門閥搖臂軸	1	
		14452-KEC8-9000	1	SHAFT EXH ROCKER ARM	排汽門閥搖臂輪	1	
		14453-KEC8-9000	0	SET PLATE ROCKER ARM SHAFT	門閥搖臂輪固定板	1	
		14510-KEC8-9000	1	TENSIONER CAM CHAIN	內鏈條拉力桿	1	
		14520-GY6-90A	1	LIFTER ASSY TENSIONER	內鏈條調整器	1	
		14523-GY6-9000	0	GASKET TENSIONER LIFTER @A	內鏈條調整器墊片	1	
		14531-KJ9-0010	0	PIVOT CAM CHAIN TENSIONER	拉力桿螺絲	1	
		14610-KEC8-9000	0	GUIDE COMP CAM CHAIN	鏈條導桿	1	
		90001-GHB-6610	0	BOLT FLANGE SHF 6*22	螺絲 6*22	2	
		90005-KEC8-9000	1	BOLT SPECIAL 6*6	特殊螺絲 6*6	1	
		90012-415-0010	0	SCR TAPPET ADJG	汽門間隙調整螺絲	2	
		90206-250-0010	0	NUT TAPPET ADJUSTING	汽門間隙調整螺帽	2	
		90465-MC4-0010	0	WASHER 8MM	華司 8MM	4	
		91306-105-6910	0	O-RING 1.5*9.5	O環 1.5*9.5	1	
		94050-08080	0	NUT FLANGE 8MM	螺帽 8MM	4	

E 2



**E 2 Cam Shaft Comp**

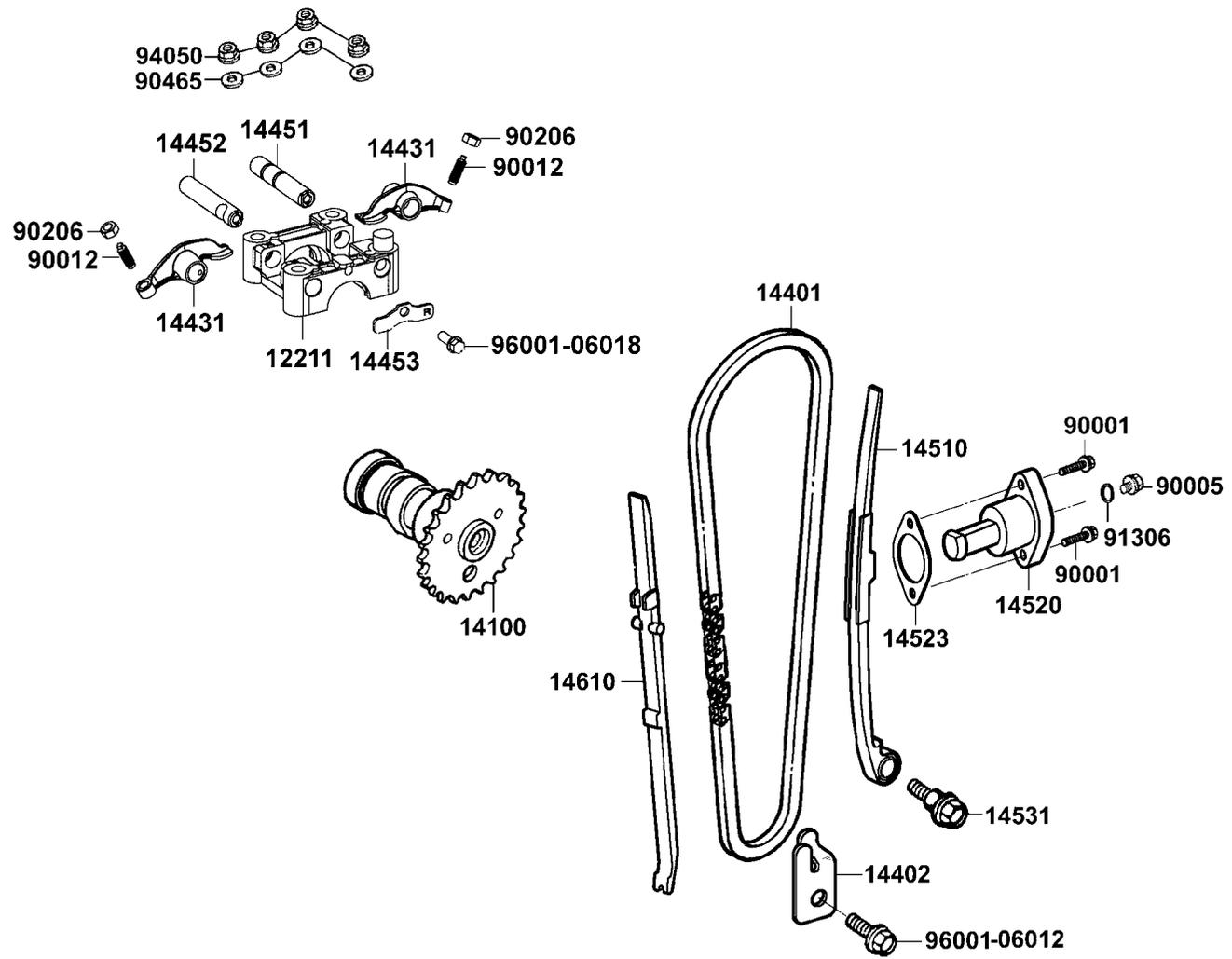

販賣記號	項目	零件號碼	版數	英文名稱	中文名稱	需要用量	參考價
Sales mark	Ref no	Part no	Ver	Description	Chinese	Regd no	Ref Price
		96001-06012-08	0	BOLT FLANGE SH 6*12	螺絲 6*12	1	
		96001-06018-08	0	BOLT FLANGE SH 6*18	螺絲 6*16	1	

E 2

**E 3 Right Crankcase Cover**

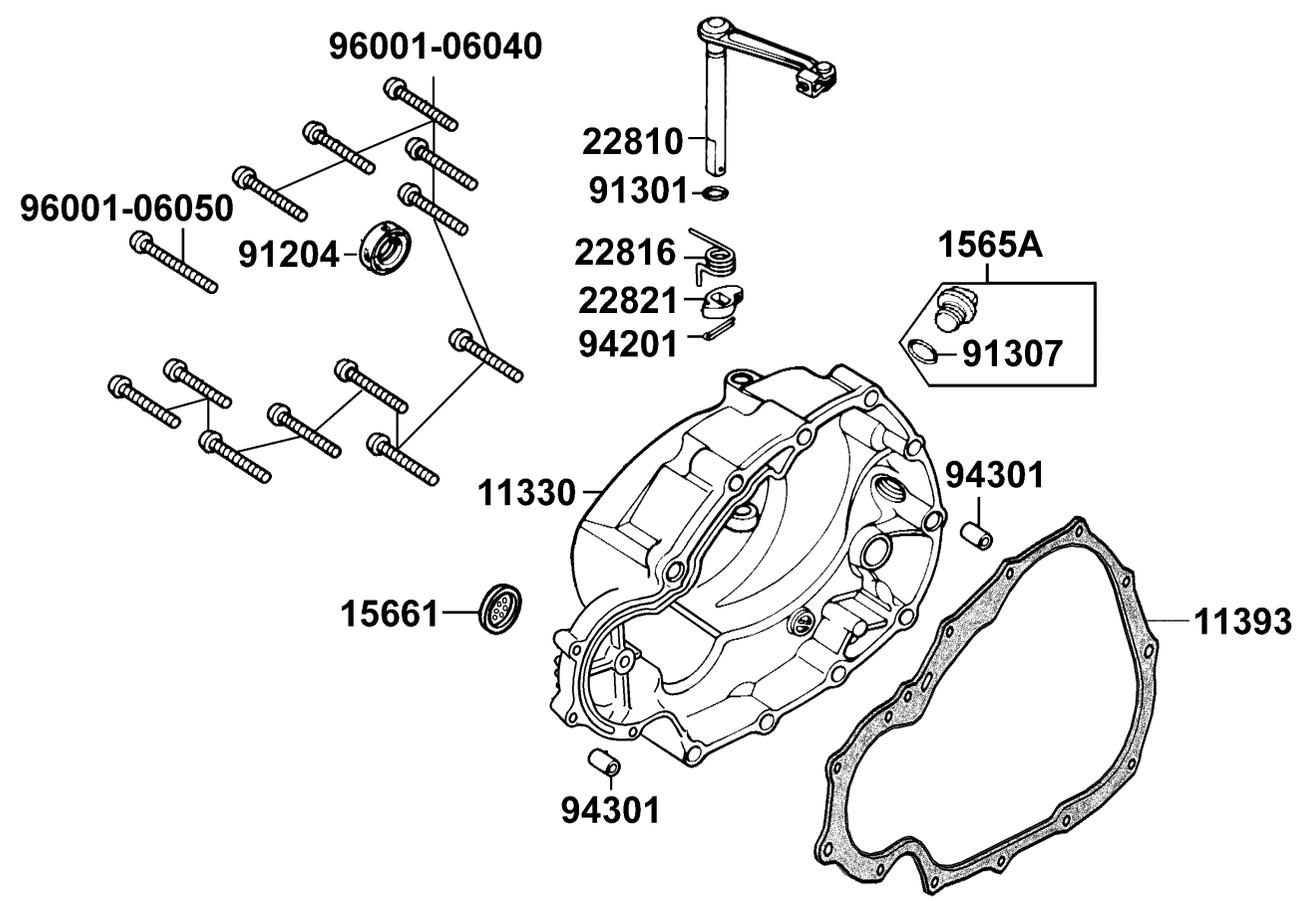

販賣記號	項目	零件號碼	版數	英文名稱	中文名稱	需要用量	參考價
Sales mark	Ref no	Part no	Ver	Description	Chinese	Regd no	Ref Price
**		11330-KEC2-900	1	COVER COMP R CRANK CASE	右曲軸箱蓋	1	
		11393-KEC2-9000	0	GASKET R CRANK CASE	右曲軸箱蓋墊片	1	
		1565A-KAK-9000	0	GAUGE OIL LEVEL ASSY	量油尺	1	
		15661-KAK-9000	3	FINDER OIL LEVEL	機油檢視窗	1	
		22810-KEC2-9000	0	LEVER COMP CLUTCH	離合器拉桿	1	
		22816-355-0000	1	SPRING CLUTCH LEVER	彈簧	1	
		22821-355-0010	0	CAM CLUTCH LIFTER	拉桿舉升凸輪	1	
		91204-259-0060	0	OIL SEAL 16*28*7	油封 16*28*7	1	
		91301-KE2-710	0	O-RING 6.8*1.9	O環 6.8*1.9	1	
		91307-035-0010	0	O-RING 18*3	O環 18*3	1	
		94201-20151	0	PIN SPLIT 2*15	插銷 2*15	1	
		94301-08140	0	DOWEL PIN 8*14	定位銷 8*14	2	
		96001-06040-02	0	BOLT FLANGE SH 6*40	螺絲 6*40	12	
		96001-06050-02	0	BOLT FLANGE SH 6*50	螺絲 6*50	1	

E 3

**E 4 Oil Pump**

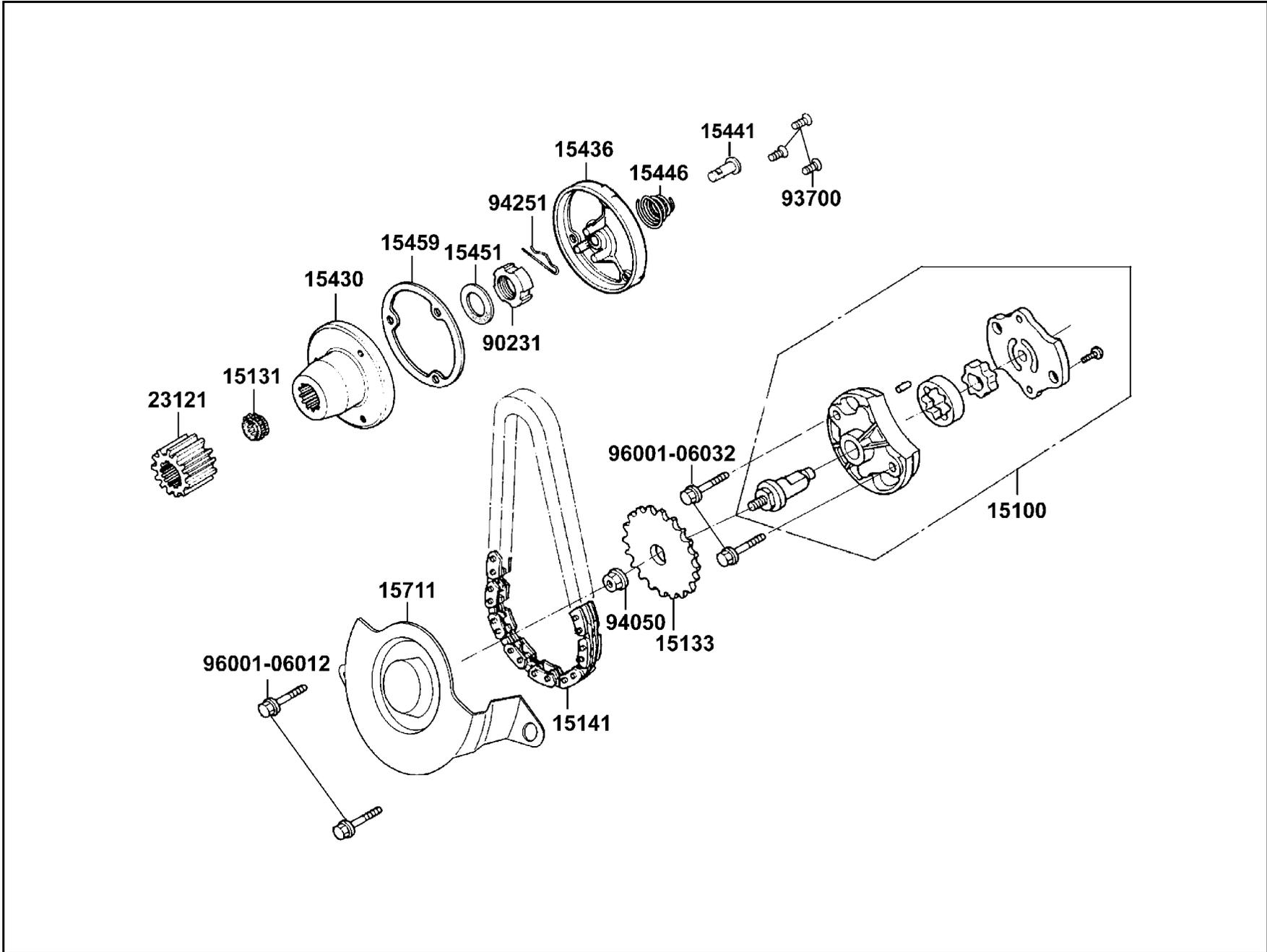

販賣記號	項目	零件號碼	版數	英文名稱	中文名稱	需要用量	參考價
Sales mark	Ref no	Part no	Ver	Description	Chinese	Regd no	Ref Price
		15100-KEC2-9000	0	PUMP ASSY OIL	機油泵浦組	1	
		15131-KEC2-9000	0	SPROCKET OIL PUMP DRIVE	機油泵齒輪	1	
		15133-GY6-9010	0	SPROCKET OIL PUMP DRIVE	機油泵驅動齒輪	1	
		15141-KEC2-9000	0	CHAIN OIL PUMP	機油泵驅動鏈條	1	
		15430-KAK-9100	0	ROTER COMP OIL FILTER	轉子	1	
		15436-107-0000	1	CAP OIL FILTER ROTOR	轉子蓋	1	
		15441-107-0000	0	OIL THROUGH	通油器	1	
		15446-107-0000	0	SPRING OIL THROUGH	通油器彈簧	1	
		15451-107-0010	0	WASHER LOCK OIL FILTER ROTOR	華司	1	
		15459-107-0010	0	GASKET OIL FILTER ROTOR CAP	轉子墊片	1	
		15711-KEC2-9000	0	SEPARTER OIL	機油分隔板	1	
		23121-KEC2-9000	0	GEAR PRIMARY DRIVE	驅動初齒輪	1	
		90231-200-0110	1	NUT LOCK 16MM	螺帽 16MM	1	
		93700-05012-0H	0	SCREW OVAL 5*12	螺絲 5*12	3	
		94050-06080	0	NUT FLANGE 6MM	螺帽 6MM	1	
		94251-08400	0	PIN LOCK 8MM	固定銷 8MM	1	
		96001-06012-08	0	BOLT FLANGE SH 6*12	螺絲 6*12	2	
		96001-06032-08	0	BOLT FLANGE SH 6*32	螺絲 6*32	2	

E 4

**E 5 Clutch**

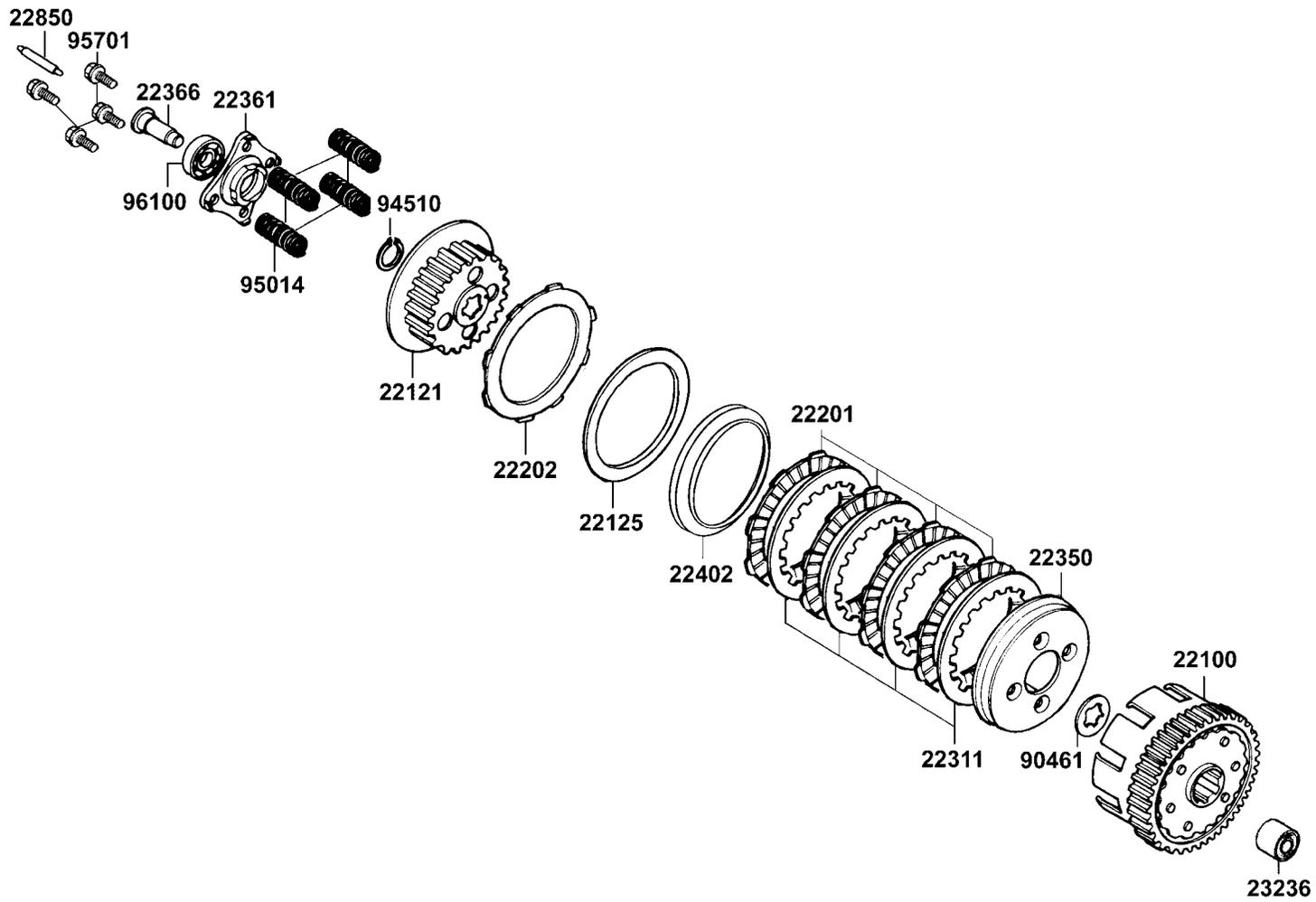

販賣記號	項目	零件號碼	版數	英文名稱	中文名稱	需要用量	參考價
Sales mark	Ref no	Part no	Ver	Description	Chinese	Regd no	Ref Price
		22100-324-0010	3	OUTER COMP CLUTCH	離合器外套	1	
		22121-107-0110	2	CENTER CLUTCH	離合器中心	1	
		22125-KAK-9000	1	SEAT ADJUSTER SPG	調節彈簧座圈	1	
		22201-KAK-9000	0	DISK CLUTCH FRICTION	離合器摩擦板	4	
		22202-KAK-9000	0	DISK CLUTCH FRICTION	離合器摩擦板	1	
		22311-107-0010	0	PLATE CLUTCH	離合器板	4	
		22350-107-0120	4	PLATE CLUTCH PRESSURE	離合器壓力板	1	
		22361-107-0010	0	PLATE CLUTCH LIFTER	離合器舉升板	1	
		22366-383-0010	0	GUIDE PIN CLUTCH LIFTER	舉升板導銷	1	
		22402-KAK-9000	1	SPR ADJUSTER	調節彈簧	1	
		22850-355-0010	0	ROD CLUTCH LIFTER	離合器舉升連桿	1	
		23236-KEC2-9000	1	COLLAR CLUTCH	套筒	1	
		90461-107-0010	0	WASHER SPLINE 20MM	華司 20MM	1	
		94510-20000	0	CIR CLIP EX 20	外環夾 20MM	1	
		95014-75110-M1	0	SPRING CLUTCH	離合器彈簧	4	
		95701-06022-08	0	BOLT FLANGE 6*22	螺絲 6*22	4	
		96100-60010-00	0	BEARING BALL RADIAL 6001	軸承 6001	1	

E 5



**E 6 Generator Starting Motor**

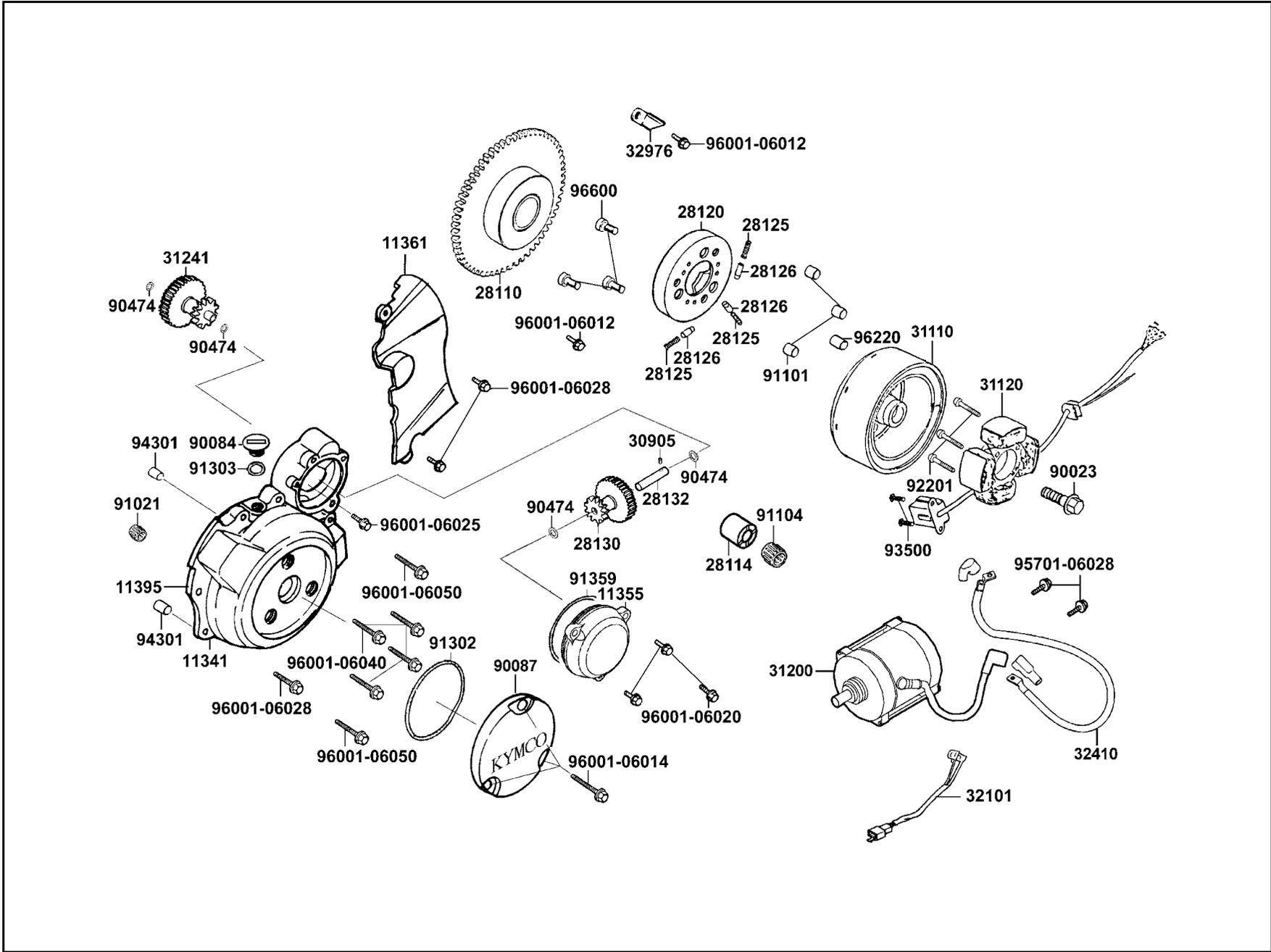

販賣記號	項目	零件號碼	版數	英文名稱	中文名稱	需要用量	參考價
Sales mark	Ref no	Part no	Ver	Description	Chinese	Regd no	Ref Price
**		11341-KEC2-900	4	COVER LEFT CRANK CASE	左曲軸箱蓋	1	
		11355-KAK-9000	0	COVER REDUCTION GEAR	減速齒輪蓋	1	
		11361-LLE2-E00	0	COVER LEFT REAR CRANK CASE	後左曲軸箱蓋	1	
		11395-KEC2-9000	0	GASKET L CRANK CASE	左曲軸箱蓋墊片	1	
		28110-KKA7-900	1	GEAR COMP STARTING DRIVEN	起動小齒輪	1	
		28114-KKA7-9000	1	BOSS STARTING GEAR COMP	襯套	1	
		28120-GY6-315	1	OUTER COMP STARTING CLUTCH	離合器外套	1	
		28125-426-0010	0	SPRING ROLLER STARTER CLUTCH	離合器滾子彈簧	3	
		28126-KDU-900	0	CAP STARTING ROLLER SPRING	滾子彈簧蓋	3	
		28130-KE2-9810	0	GEAR COMP REDUCTION	起動減速齒輪	1	
		28132-KG7-0010	0	SHAFT REDUCTION GEAR	減速齒輪軸	1	
		30905-216-0010	0	KNOCK PIN 3*5.2	固定銷 3*5.2	1	
		31110-KE2-9600	1	FLYWHEEL COMP	飛輪	1	
		31120-KBH-9000	0	STATOR COMP	轉子線圈	1	
		31200-KAK-9000	0	MOTOR ASSY STARTER	起動馬達	1	
		31241-KE2-9810	1	SHAFT STARTER GEAR	起動齒輪	1	
		32101-KHE7-E000	0	SUB CORD	加熱器配線	1	
		32410-LLE2-E00	0	CABLE START MOTOR	起動馬達配線	1	
		32976-107-0010	0	CLAMPER WIRE HARNESS	配線固定夾	1	
		90023-KG7-0010	0	BOLT ROTOR SETTING	螺絲	1	

E 6

**E 6 Generator Starting Motor**

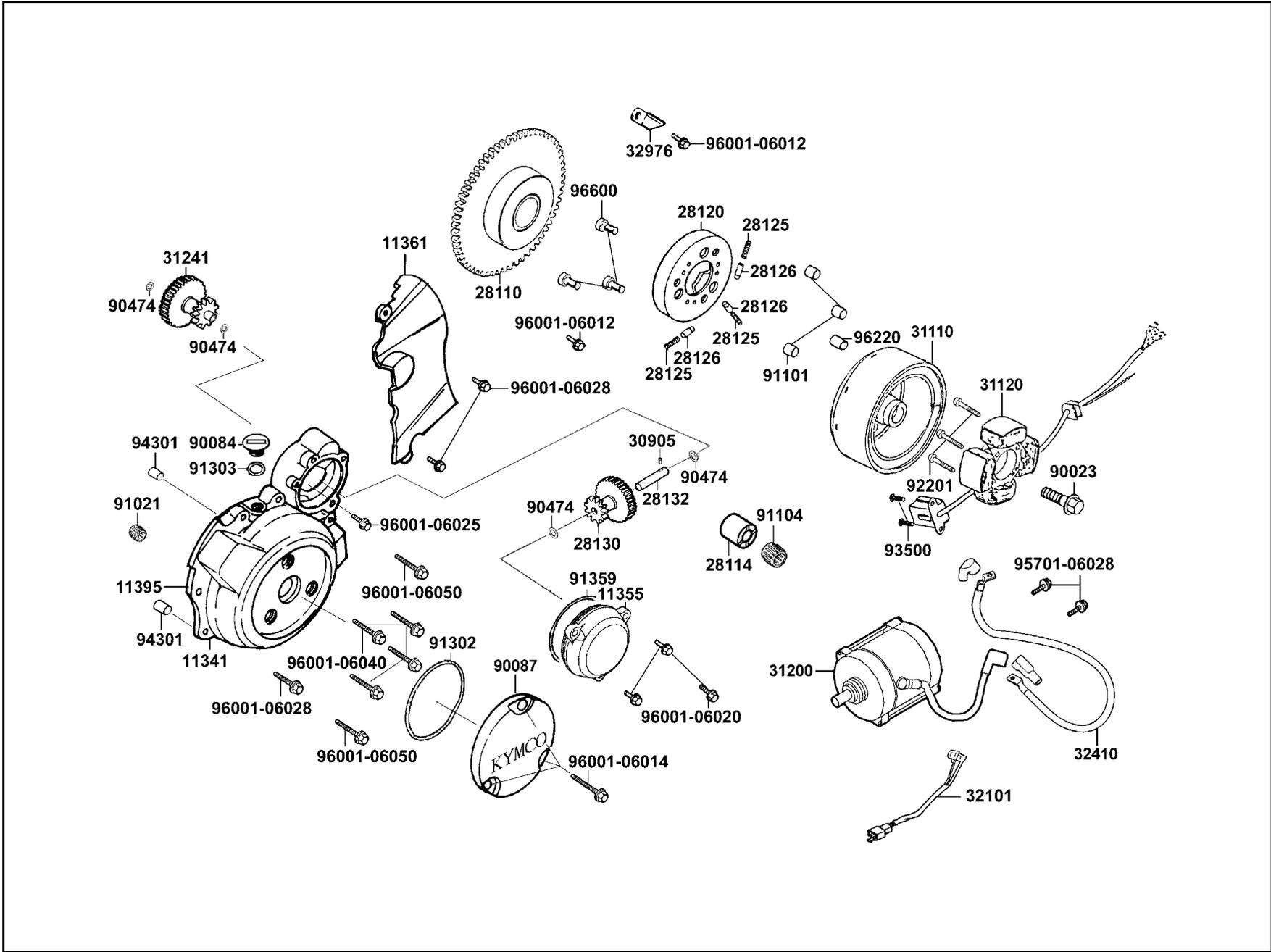

販賣記號	項目	零件號碼	版數	英文名稱	中文名稱	需要用量	參考價
Sales mark	Ref no	Part no	Ver	Description	Chinese	Regd no	Ref Price
		90084-KAK-9000	0	CAP AC GENERATOR	A. C. G 蓋	1	
		90087-KAK-9000	1	CAP	蓋子	1	
		90474-147-0010	0	WASHER 10.5MM	華司 10.5MM	4	
		91021-148-0050	0	BEARING NEEDLE 1010	軸承 1010	1	
		91101-179-7110-M1	0	ROLLER 10*10	滾子 10*10	3	
		91104-KEC8-9000-M1	0	BRG NEEDLE 22*28*17V2	軸承 22*28*17V2	1	
		91302-567-0040	0	O-RING 27.4*2.4	O環 27.4*2.4	1	
		91303-377-0010	0	O-RING 13.8*2.5	O環 13.8*2.5	1	
		91359-371-0040	0	O-RING 63*3.0	O環 63*3	1	
		92201-05025-0H	0	BOLT HEX 5*25	螺絲 5*25	3	
		93500-05016-0H	0	SCREW PAN 5*16	螺絲 5*16	2	
		94301-10140	0	DOWEL PIN 10*14	定位銷 10*14	2	
		95701-06028-02	0	BOLT FLANGE 6*28	螺絲 6*28	2	
		96001-06012-08	0	BOLT FLANGE SH 6*12	螺絲 6*12	2	
		96001-06014-02	0	BOLT FLANGE SH 6*14	螺絲 6*14	3	
		96001-06020-02	0	BOLT FLANGE SH 6*20	螺絲 6*20	3	
		96001-06025-08	0	BOLT FLANGE SH 6*25	螺絲 6*25	1	
		96001-06028-02	0	BOLT FLANGE SH 6*28	螺絲 6*28	3	
		96001-06040-02	0	BOLT FLANGE SH 6*40	螺絲 6*40	4	
		96001-06050-02	0	BOLT FLANGE SH 6*50	螺絲 6*50	2	

E 6

**E 6 Generator Starting Motor**

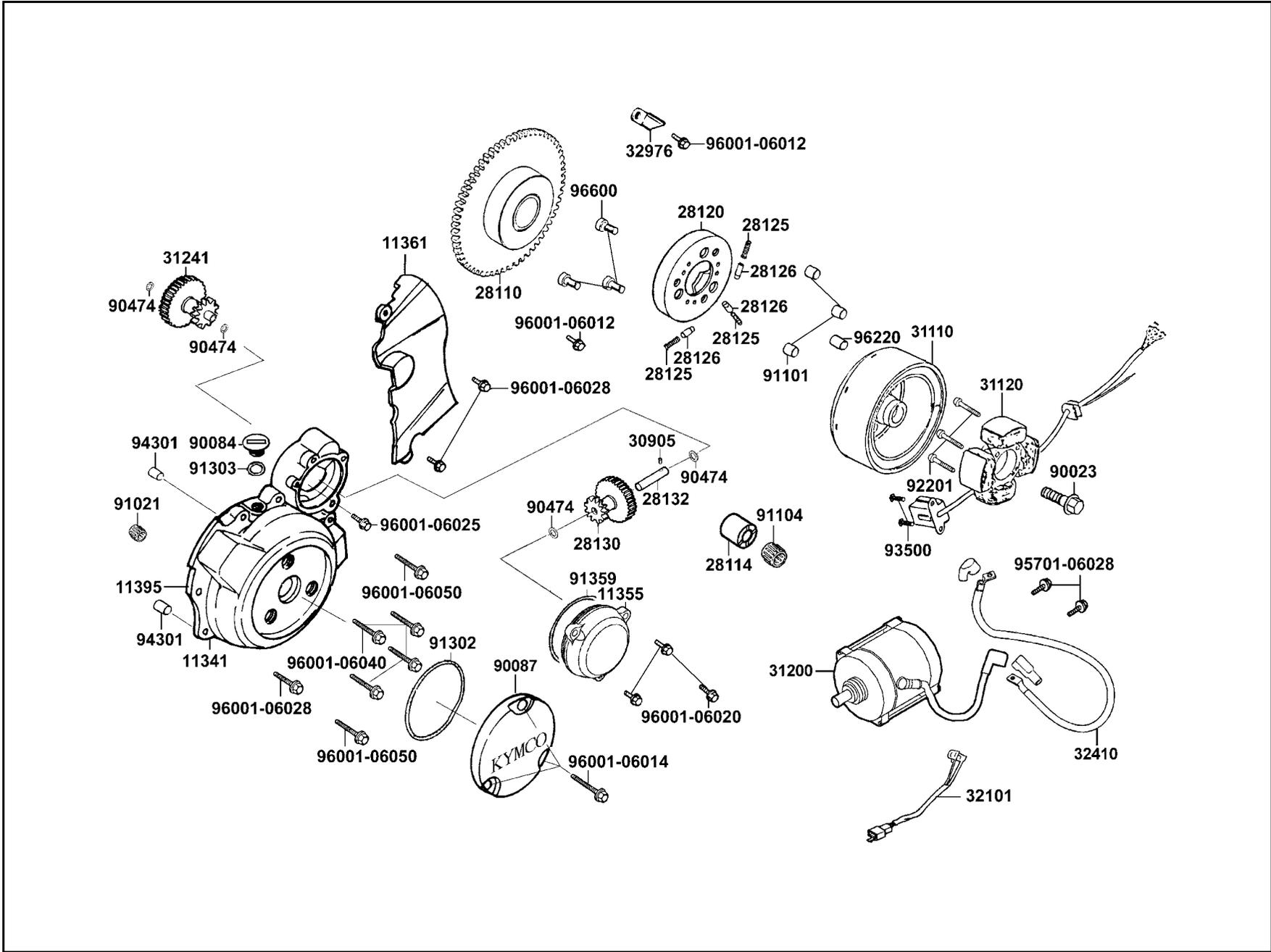

販賣記號	項目	零件號碼	版數	英文名稱	中文名稱	需要用量	參考價
Sales mark	Ref no	Part no	Ver	Description	Chinese	Regd no	Ref Price
		96220-60100	0	ROLLER 6*10	定位銷 6*10	1	
		96600-08015-10	1	SOCKET BOLT 8*15	螺絲 8*15	3	

E 6

**E 7 Crankcase**

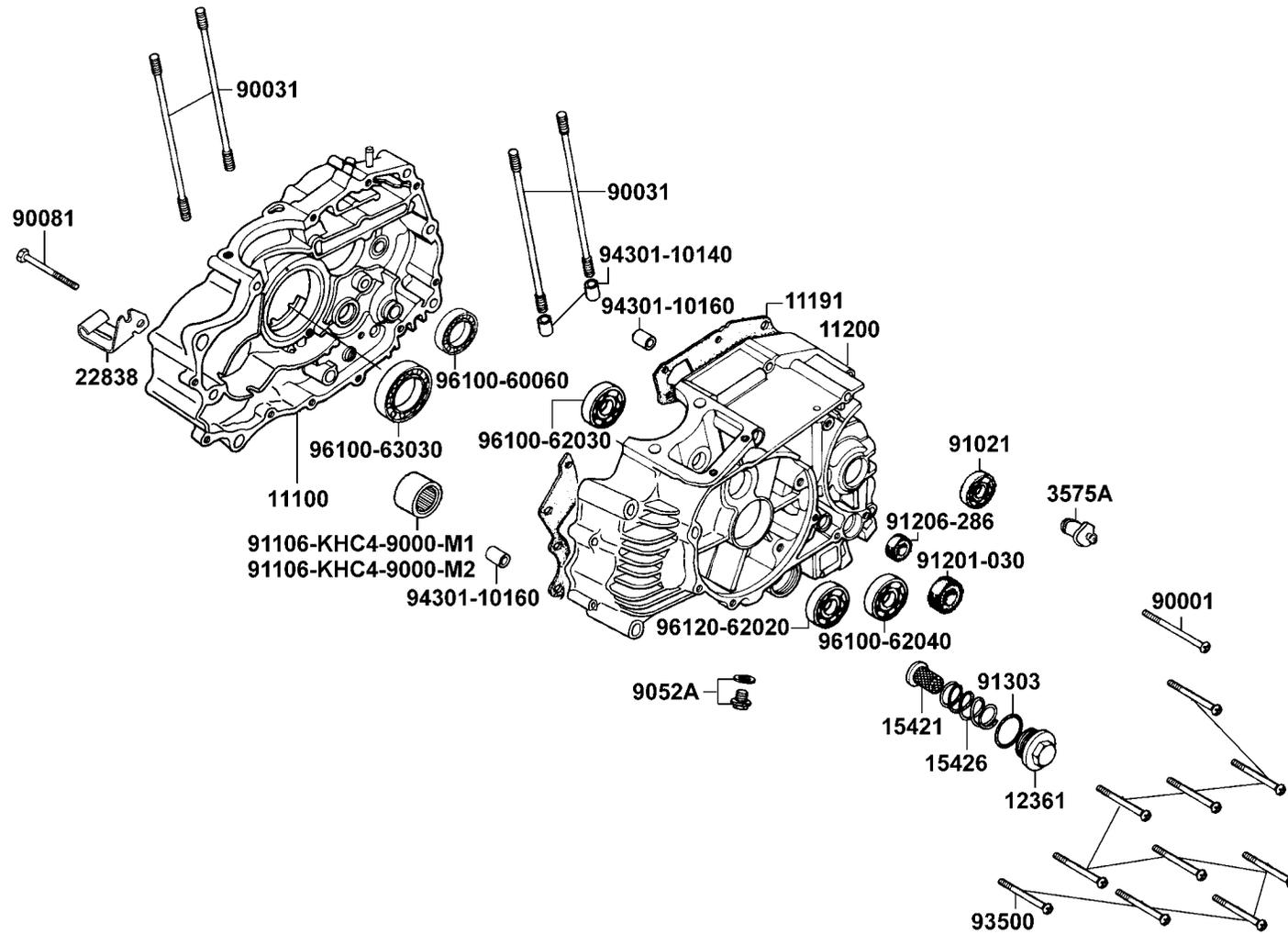

販賣記號	項目	零件號碼	版數	英文名稱	中文名稱	需要用量	參考價
Sales mark	Ref no	Part no	Ver	Description	Chinese	Regd no	Ref Price
		11100-KHC7-E000	0	CRANK CASE COMP RIGHT	右曲軸箱	1	
		11191-KEC2-9000	0	GASKET CRANK CASE	曲軸箱墊片	1	
		11200-KKA7-9000	1	CRANK CASE COMP LEFT	左曲軸箱	1	
		12361-107-0010	0	HOLE CAP TAPPET ADJUSTING	調節螺帽	1	
		15421-107-0000	1	SCREEN OIL FILTER	濾油網	1	
		15426-107-0000	0	SPRING OIL FILTER SCREEN	濾油網彈簧	1	
		22838-KEC2-9000	0	HOLDER CLUTCH WIRE	離合器導線固定座	1	
		3575A-001-0200	0	NEUTRAL SW ASSY	中立燈開關	1	
		90001-KAK-9000	0	SCREW PAN 6*95	螺絲 6*95	1	
		90031-KBE-9000	0	BOLT A STUD 8MM	雙頭螺絲 8MM	4	
		90081-KAK-9000	0	BOLT HS 6*55	螺絲 6*55	1	
		9052A-GY6-9500	0	BOLT ASSY DRAIN PLUG	洩油螺絲	1	
		91021-148-0050	0	BEARING NEEDLE 1010	軸承 1010	1	
		91106-KHC4-9000-M1	0	BRG NEEDLE 15MM	滾針軸承	1	
		91106-KHC4-9000-M2	0	BRG NEEDLE 15MM	滾針軸承	1	
		91201-030-0330	0	OIL SEAL S 20*34*7	油封 20*34*7	1	
		91206-286-0140	0	OIL SEAL 14*28*7	油封 14*28*7	1	
		91303-107-0000	1	O-RING 35*3.0	O環 35*3	1	
		93500-06050-0H	0	SCREW PAN 6*50	螺絲 6*50	10	
		94301-10140	0	DOWEL PIN 10*14	定位銷 10*14	2	

E 7



**E 7 Crankcase**

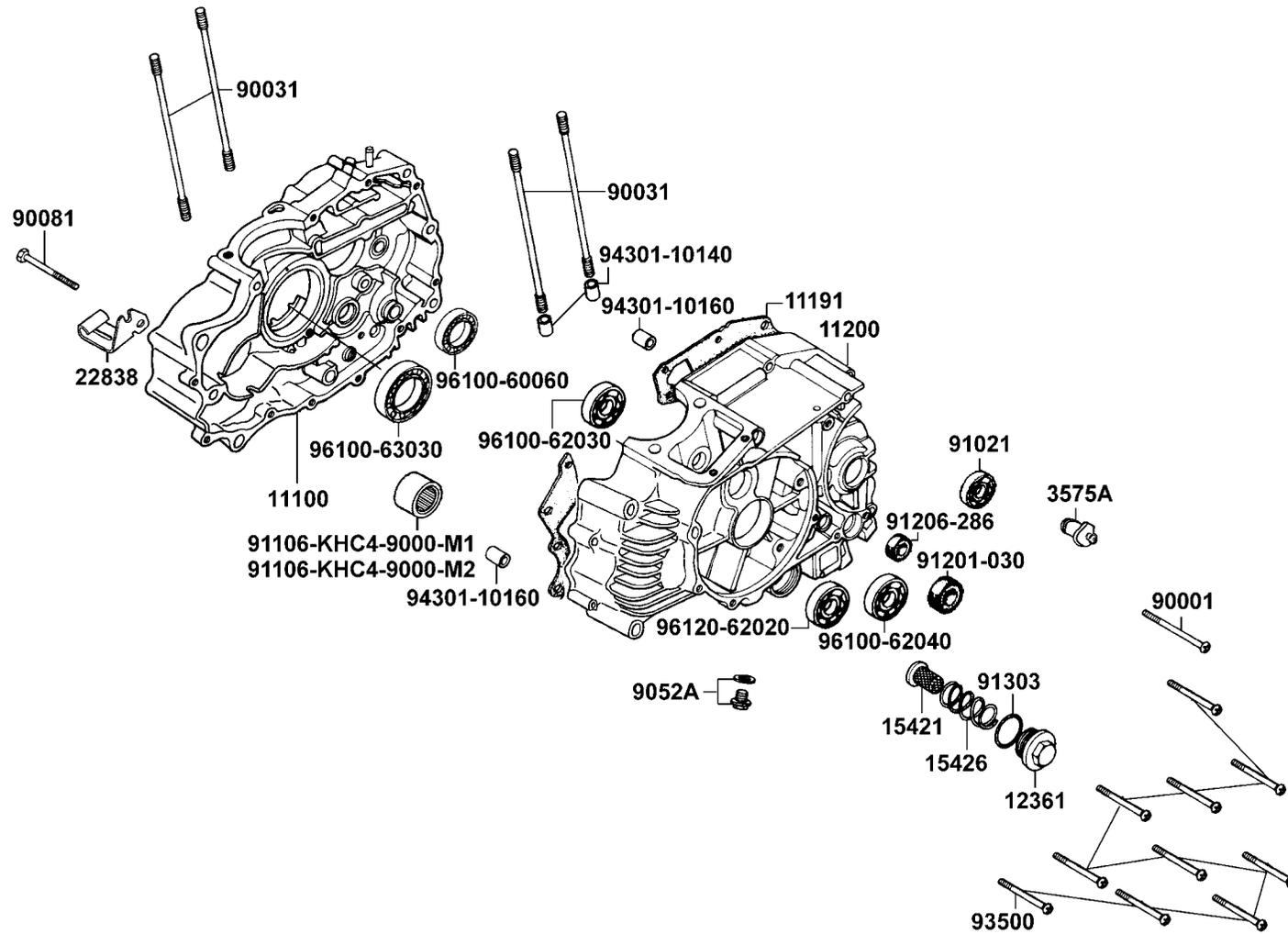

販賣記號	項目	零件號碼	版數	英文名稱	中文名稱	需要用量	參考價
Sales mark	Ref no	Part no	Ver	Description	Chinese	Regd no	Ref Price
		94301-10160	0	DOWEL PIN 10*16	定位銷 10*16	2	
		96100-60060-00	0	BEARING BALL RADIAL 6006	軸承 6006	1	
		96100-62030-00	0	BEARING BALL RADIAL 6203	軸承6203	1	
		96100-62040-00	0	BEARING BALL RADIAL 6204	軸承 6204	1	
		96100-63030-00	0	BEARING BALL RADIAL 6303	軸承 6303	1	
		96120-62020-00	0	BEARING BALL RADIAL 6202	軸承 6202	1	

E 7

**E 8 Crank Shaft●Piston**

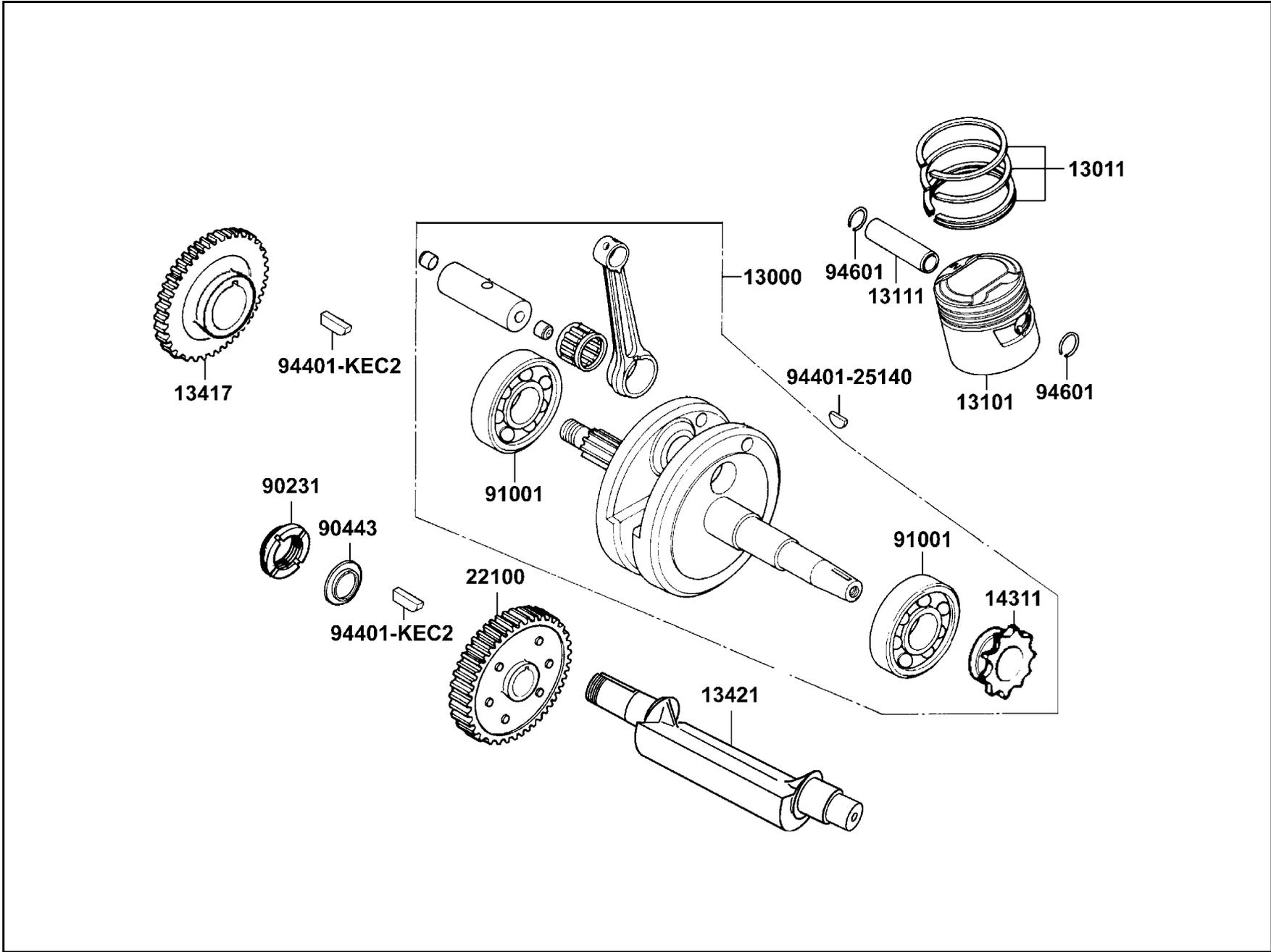

販賣記號	項目	零件號碼	版數	英文名稱	中文名稱	需要用量	參考價
Sales mark	Ref no	Part no	Ver	Description	Chinese	Regd no	Ref Price
		13000-KKA8-900	1	CRANK SHAFT COMP	曲軸	1	
		13011-383-6210-M2	0	RING SET PISTON	活塞環組	1	
		13101-383-5000	0	PISTON	活塞	1	
		13111-440-0010	0	PIN PISTON	活塞銷	1	
		13417-KEC2-9000	0	GEAR BALANCE DRIVE	驅動平衡齒輪	1	
		13421-KKA8-9000	0	SHAFT BALANCER	平衡軸	1	
		14311-KEC8-9000-H1	1	SPROCKET TIMING	正時齒輪	1	
		22100-KEC2-9000	3	GEAR COMP BAL	平衡齒輪	1	
		90231-KEC2-9000	1	NUT LOCK 16MM	鎖螺帽 16MM	1	
		90443-KEC2-9000	0	WASHER GEAR BAL	平衡軸華司	1	
		91001-KEC8-9000	0	BRG BALL RAD 63/28JR2	軸承63/28JR2	2	
		94401-25140-M1	0	WOODRUFF KEY 25*14	固定鍵 25*14	1	
		94401-KEC2-9000	0	KEY WOODRUFF 16*13	固定鍵 16*13	2	
		94601-15000-M1	0	CLIP PISTON PIN 15MM	活塞銷夾 15MM	2	

E 8

**E 9** Transmission ● Kick Starter

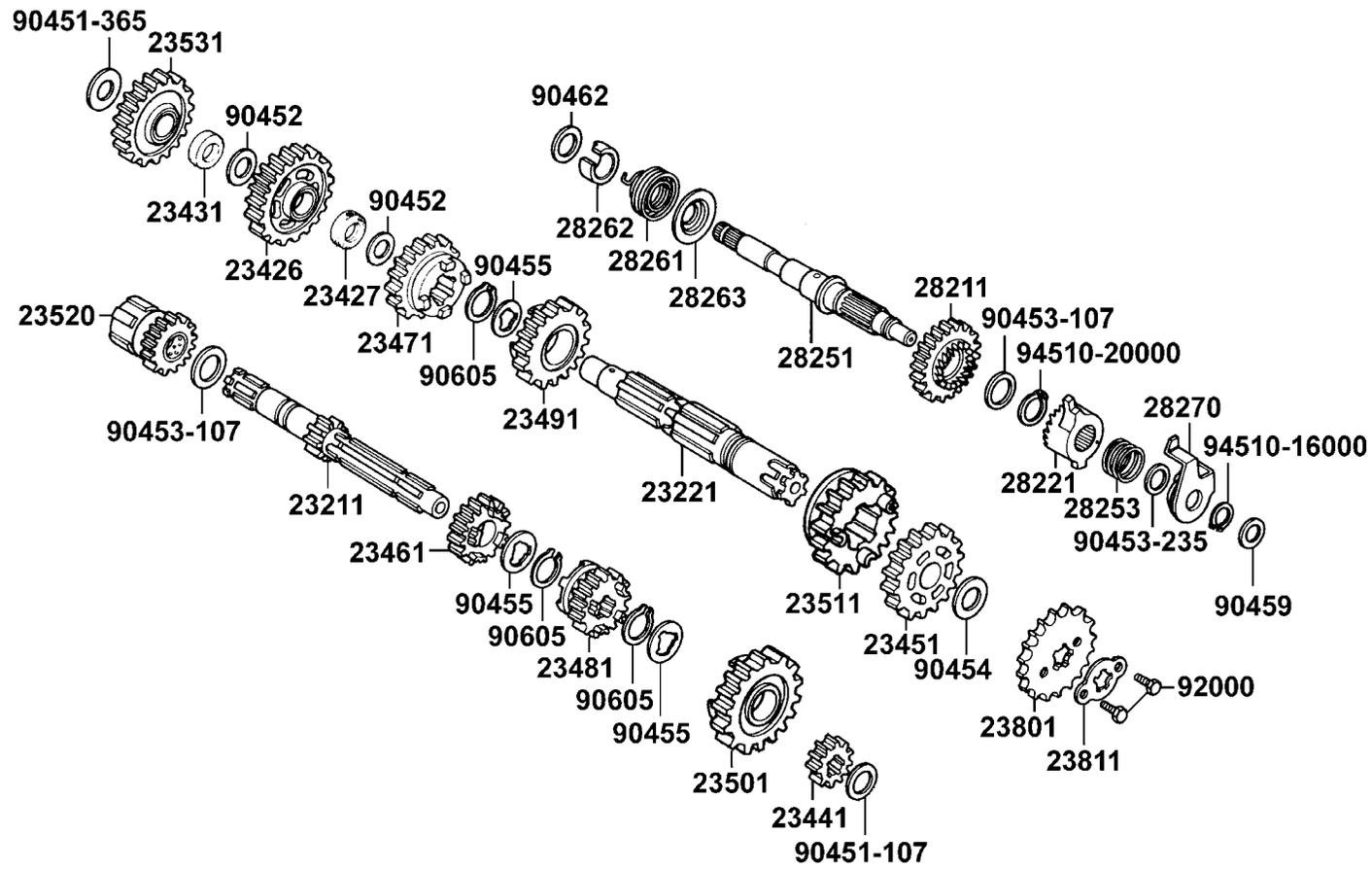

販賣記號	項目	零件號碼	版數	英文名稱	中文名稱	需要用量	參考價
Sales mark	Ref no	Part no	Ver	Description	Chinese	Regd no	Ref Price
		23211-KEC2-9000	0	SHAFT MAIN TRANSMISSION	主軸	1	
		23221-KAK-9000	0	SHAFT COUNTER TRANSMISSION	傳動副軸	1	
		23426-KAK-9000	0	GEAR COUNTER SHAFT LOW	副軸第一齒輪	1	
		23427-439-0010	0	COLLAR COUNTER SHAFT LOW GEAR	對軸低速齒輪軸環	1	
		23431-439-0010	0	COLLAR IDLE STARTER GEAR	起動惰齒輪軸環	1	
		23441-KAK-9000	0	GEAR M-2	主軸第二齒輪	1	
		23451-KAK-9000	0	GEAR C-2	副軸第二齒輪	1	
		23461-439-001	3	GEAR M-3	主軸第三齒輪	1	
		23471-439-001	1	GEAR C-3	副軸第三齒輪	1	
		23481-439-0010	1	GEAR M-4	主軸第四齒輪	1	
		23491-439-0010	0	GEAR C-4	副軸第四齒輪	1	
		23501-KKA8-9000	0	MAIN SHAFT FIFTH 26T	主軸五速齒輪	1	
		23511-KKA8-9000	0	GEAR C-5 24T	副軸五速齒輪	1	
		23520-KEC2-9000	0	GEAR COMP STARTER	驅動最初齒輪	1	
		23531-439-0010	0	GEAR ONLY IDLE STARTER	驅動最初惰齒輪	1	
		23801-KAK-9000	0	SPROCKET DRIVE	驅動齒輪	1	
		23811-KR3-6010	0	PLATE A2 FIXING	固定板 A2	1	
		28211-397-0110	0	PINION KICK STARTER	起動小齒輪	1	
		28221-397-0210	0	RATCHET KICK STARTER	起動小齒輪掣子	1	
		28251-397-0110	1	SPINDLE KICK STARTER	起動臂軸	1	

E 9

**E 9** Transmission ● Kick Starter

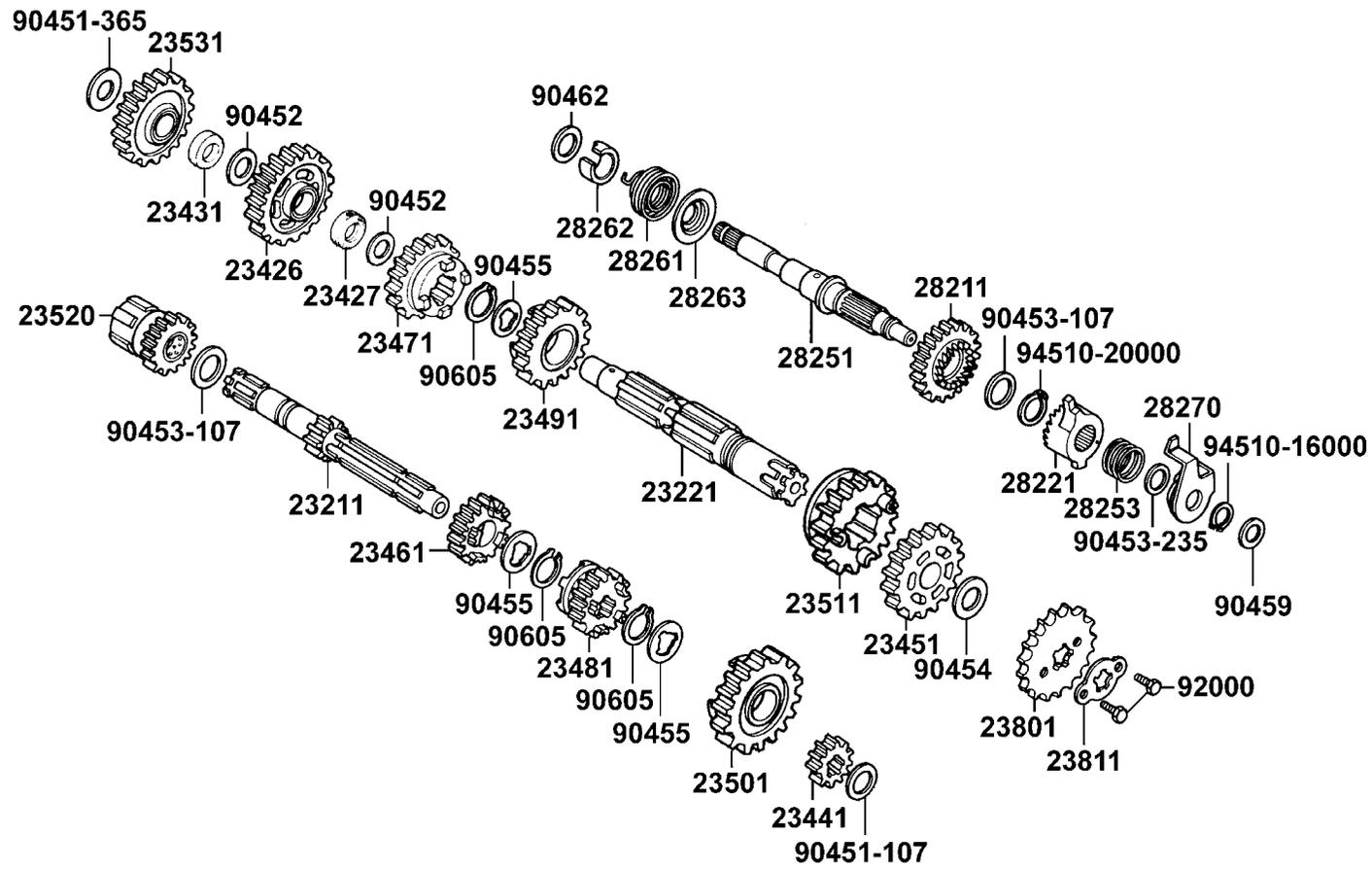

販賣記號	項目	零件號碼	版數	英文名稱	中文名稱	需要用量	參考價
Sales mark	Ref no	Part no	Ver	Description	Chinese	Regd no	Ref Price
		28253-397-0010	0	SPRING KICK STARTER RATCHET	起動臂彈簧	1	
		28261-397-0010	2	SPRING KICK STARTER	起動彈簧	1	
		28262-397-0010	0	COLLAR KICK SPINDLE	起動臂軸套筒	1	
		28263-397-0010	0	RETAINER STARTER SPRING	起動彈簧承座	1	
		28270-397-0210	0	PLATE COMP RATCHET GUIDE	掣子導片	1	
		90451-107-0000	1	WASHER THRUST 15M/M	華司 15MM	1	
		90451-365-0010	0	WASHER THRUST 15M/M	華司 15MM	1	
		90452-107-0010	0	WASHER THRUST 16.5M/M	華司 16.5MM	2	
		90453-107-0020	0	WASHER THRUST 20M/M	華司 20MM	2	
		90453-235-0010	0	WASHER THRUST 16MM	華司 16MM	1	
		90454-107-0010	0	WASHER THRUST 20MM B	華司 20MM	1	
		90455-107-0010	0	WASHER SPLINE 20M/M A	華司 20MM	3	
		90459-107-0010	0	WASHER THRUST 12MM	華司 12MM	1	
		90462-107-0010	0	WASHER THRUST 16M/M	華司 16MM	1	
		90605-200-0010	0	SET RING 20MM	固定環 20MM	3	
		92000-06010-0H	0	BOLT HEX 6*10	螺絲 6*10	2	
		94510-16000	0	CIR CLIP EX 16	外環夾	1	
		94510-20000	0	CIR CLIP EX 20	外環夾 20MM	1	

E 9





販賣記號	項目	零件號碼	版數	英文名稱	中文名稱	需要用量	參考價
Sales mark	Ref no	Part no	Ver	Description	Chinese	Regd no	Ref Price
		24211-107-0020	0	FORK RIGHT GEAR SHIFT	齒輪變換右叉	1	
		24221-355-0020	0	FORK LEFT GEAR SHIFT	齒輪變換左叉	1	
		24231-107-0110	0	FORK CENTER GEAR SHIFT	齒輪變換中叉	1	
		24241-107-0010	0	SHAFT GEAR SHIFT FORK GUIDE	變換叉樞軸	1	
		24301-KAK-9000	2	DRUM GEAR SHIFT	齒輪變速鼓輪	1	
		24411-KAK-9000	0	CAM GEAR SHIFT	齒輪變速凸輪	1	
		24430-324-0010	0	STOPPER COMP GEAR SHIFT DRUM	齒輪軸板	1	
		24435-KAK-9000	0	SPG SHIFT DRUM STOPPER	軸板彈簧	1	
		24610-KC6-0010	1	SPINDLE COMP GEAR SHIFT	齒輪變換樞軸	1	
		24621-107-7610	0	PLATE GEAR SHIFT	齒輪軸板	1	
		24631-107-0010	0	SPRING GEAR SHIFT PLATE	齒輪軸彈簧	1	
		24651-398-9410	0	SPRING GEAR SHIFT RETURN	齒輪變換回轉彈簧	1	
		35753-028-6020	0	NEUTRAL SWITCH ROTOR	中立開關銅片	1	
		90451-001-0010	0	WASHER THRUST 14M/M	華司 14MM	2	
		92000-06020-0H	0	BOLT HEX 6*20	螺絲 6*20	1	
		92000-06025-0H	0	BOLT HEX 6*25	螺絲 6*25	1	
		94510-12000	0	CIR CLIP EX 12	外環夾 12MM	1	
		94510-14000	0	CIR CLIP EX 14	外環夾 14MM	1	
		96220-40100-M1	0	ROLLER 4*10	滾子 4*10	1	

E 10

# E 11 Carburetor

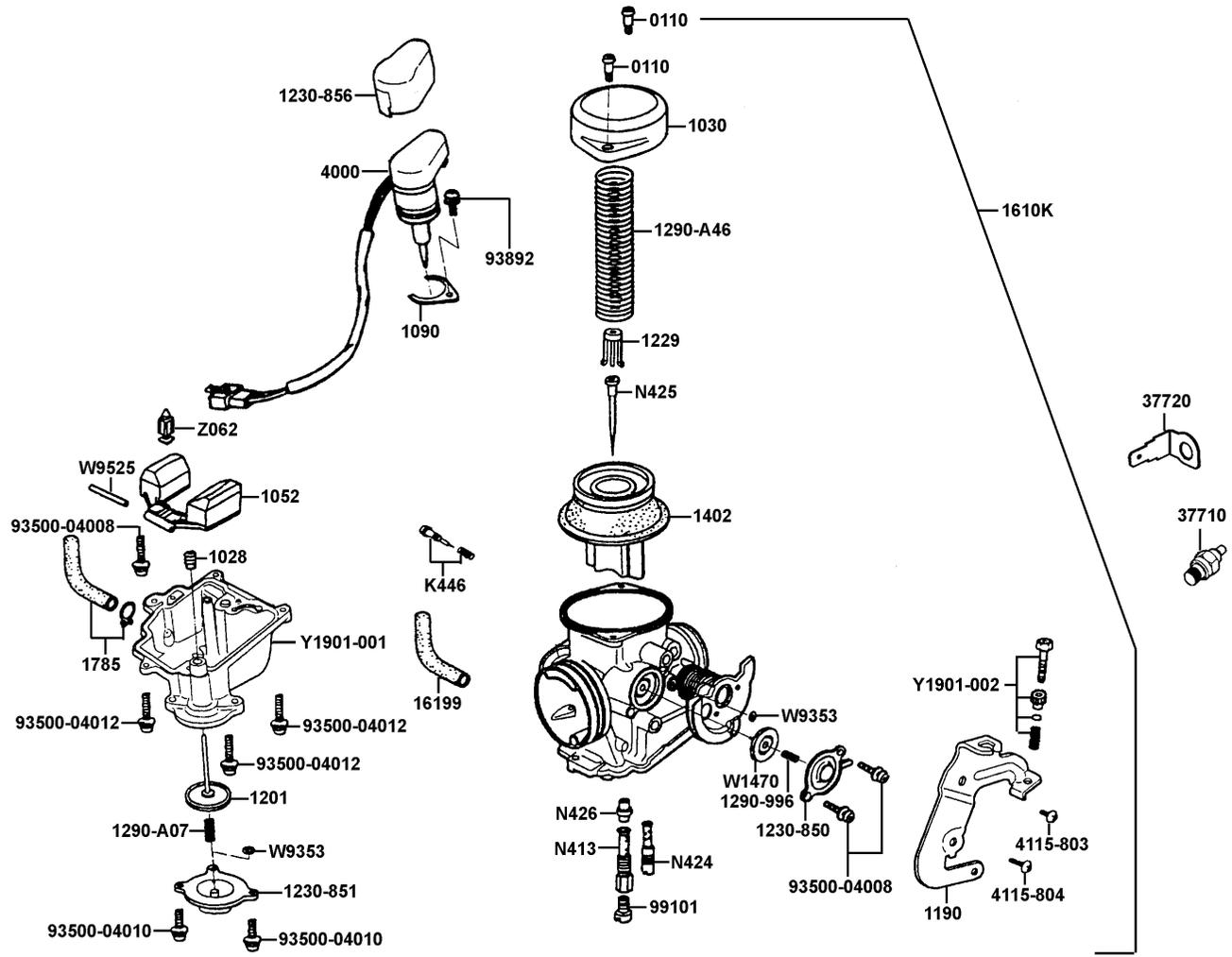

販賣記號	項目	零件號碼	版數	英文名稱	中文名稱	需要用量	參考價
Sales mark	Ref no	Part no	Ver	Description	Chinese	Regd no	Ref Price
		0110-803-1100	0	SCREW PAN	平頭螺絲	2	
		1028-054-7000	0	SEALING CAP	護蓋油封	1	
		1030-873-7003	0	TOP SET	真空活塞閥蓋	1	
		1052-862-2100	1	FLOAT COMP	浮筒組	1	
		1090-873-2001	0	SET PLATE	固定板	1	
		1190-B07-2101	0	STAY PLATE SET	支架固定板	1	
		1201-830-2200	0	DIAPHRAGM COMP	阻風閥	1	
		1229-805-7000	0	VALVE PLATE SET	安全閥固定板	1	
		1230-850-2000	0	COVER	護蓋	1	
		1230-851-2001	0	COVER	護蓋	1	
		1230-856-7001	0	HOLDER CAP	自動起動閥蓋	1	
		1290-996-2000	0	SPG COMPR	彈簧	1	
		1290-A07-2000	0	SPG COMPR	彈簧	1	
		1290-A46-2000	0	SPG COMPR	彈簧	1	
		1402-912-2201	0	VACUUM PISTON COMP	真空活塞閥	1	
		1610K-LLE2-E000	0	CARBURETOR ASSY	化油器	1	
		16199-GY6-9000	0	TUBE SET	空氣管	1	
		1785-402H-0040-SB00	0	TUBE SET	空氣管	1	
		37710-KGBG-E000	0	HEATER CARBURETOR	加熱器	1	
		37720-KGBG-E000	0	EARTH TERMINAL HEATER	接地板	1	

E 11

# E 11 Carburetor

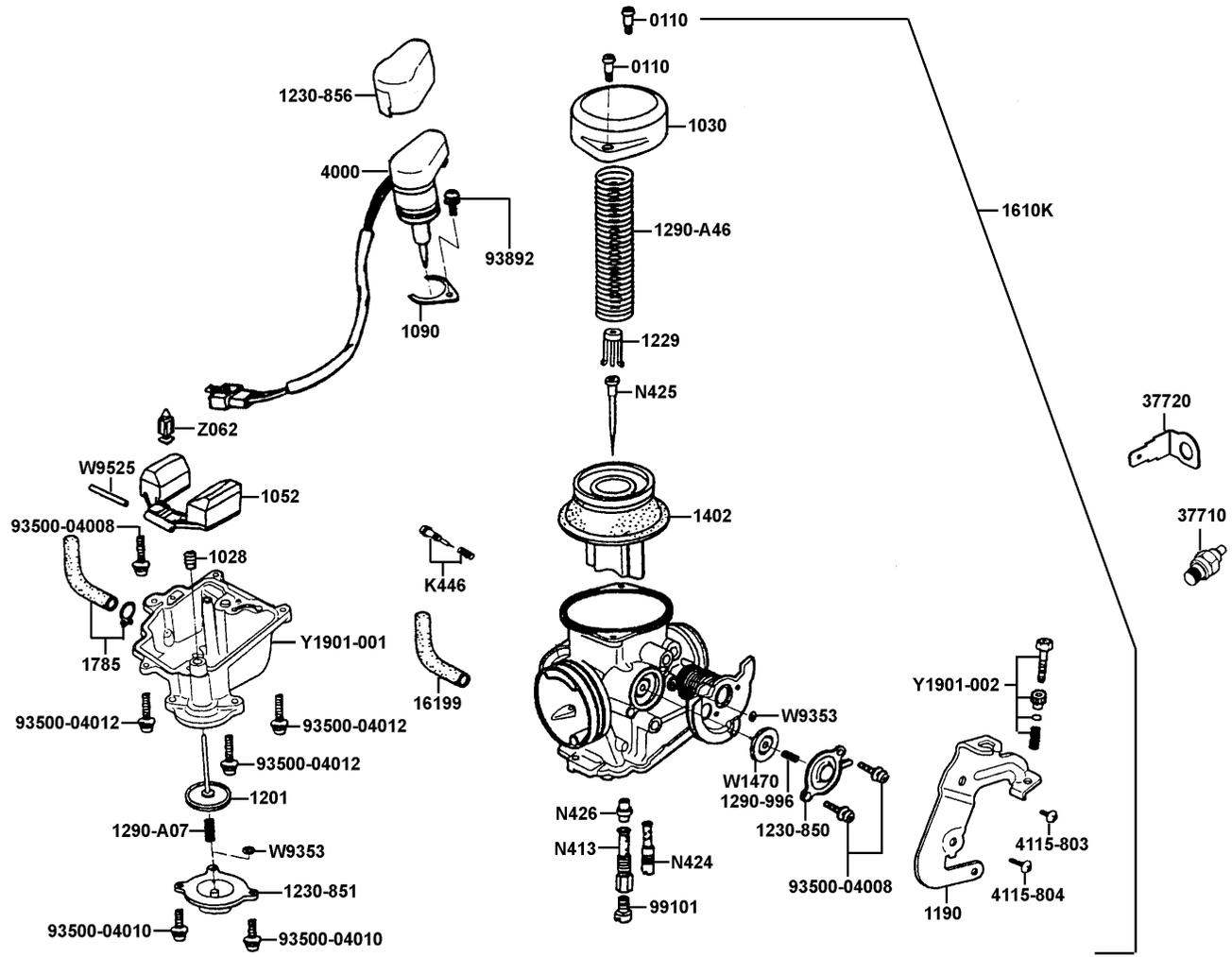

販賣記號	項目	零件號碼	版數	英文名稱	中文名稱	需要用量	參考價
Sales mark	Ref no	Part no	Ver	Description	Chinese	Regd no	Ref Price
		4000-069-0004	0	AUTO BYSTARTER SET	自動旁通器	1	
		4115-803-1100	0	SCREW PAN	平頭螺絲	1	
		4115-804-1100	0	SCREW PAN	平頭螺絲	1	
		93500-04008-1H	0	SCREW PAN	螺絲	3	
		93500-04010-1H	0	SCREW PAN	平頭螺絲	2	
		93500-04012-1H	0	SCREW PAN	平頭螺絲	3	
		93892-04008-18	0	SCREW WASHER 4*8	螺絲 4*8	1	
		99101-116-1080	0	MAIN JET	主噴油嘴	1	
		K446-A31-0100	0	SCREW SET	螺絲	1	
		N413-18C00	0	NEEDLE JET HOLDER	油針支座	1	
		N424-45A35	0	SLOW JET	慢速噴油嘴	1	
		N425-4HLNL	0	JET NEEDLE COMP	油針	1	
		N426-33C00	0	NEEDLE JET	噴嘴	1	
		W1470-MW0-7500	0	DIAPHRAGM COMP	旁通閥	1	
		W9353-36000	0	U RING	U 形環	2	
		W9525-25250	0	ARM PIN	浮筒閥臂銷	1	
		Y1901-001-3700	0	FLOAT CHAMBER SET	浮筒室閥	1	
		Y1901-002-0200	0	SCREW SET	螺絲組	1	
		Z062-0060	0	FLOAT VALVE SET	浮筒安全閥	1	

E 11

**E 12 Reed Valve**

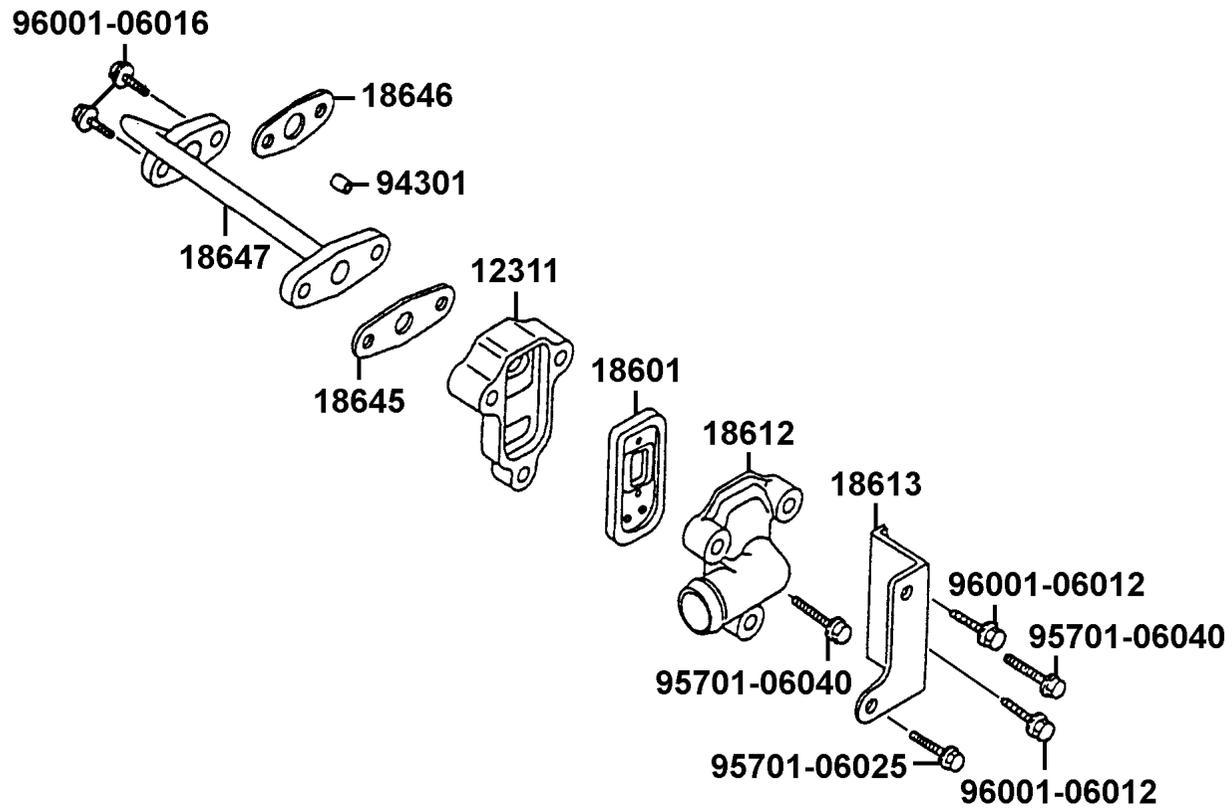

販賣記號	項目	零件號碼	版數	英文名稱	中文名稱	需要用量	參考價
Sales mark	Ref no	Part no	Ver	Description	Chinese	Regd no	Ref Price
		12311-KE2-900	4	BODY REED VALVE	單向閥	1	
		18601-KE2-9000	0	REED VALVE COMP LDV 52*27*6.0	單向閥	1	
		18612-KAK-9000	0	COVER REED VALVE	簧片單向閥蓋	1	
		18613-KAK-9000	0	STAY REED VALVE ASSY	單向閥支架	1	
		18645-GY6-9400	0	GSKT A/I PIPE	通氣鐵管墊片	1	
		18646-GY6-9400	0	GSKT A/I PIPE	通氣管墊片	1	
		18647-KAK-9000	0	PIPE COMP AIR	通氣鐵管	1	
		94301-10140	0	DOWEL PIN 10*14	定位銷 10*14	1	
		95701-06025-08	0	BOLT FLANGE 6*25	螺絲 6*25	1	
		95701-06040-02	0	BOLT FLANGE 6*40	螺絲 6*40	2	
		96001-06012-02	0	BOLT FLANGE SH 6*12	螺絲 6*12	2	
		96001-06016-02	0	BOLT FLANGE SH 6*16	螺絲 6*16	2	

E 12



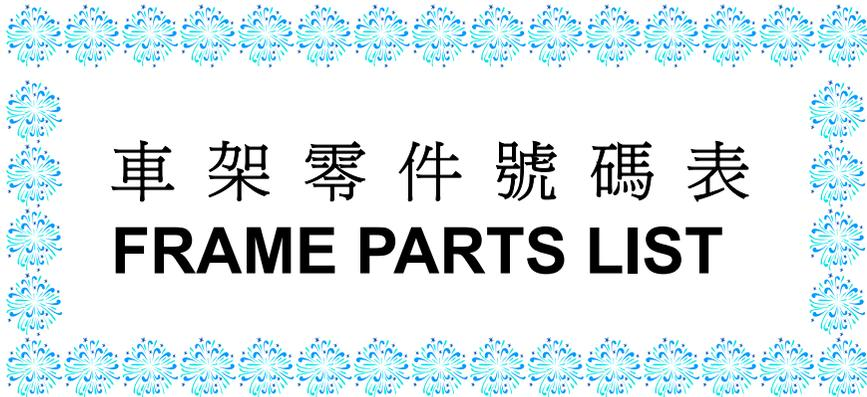

車架零件號碼表  
**FRAME PARTS LIST**

**F 1** Head Light

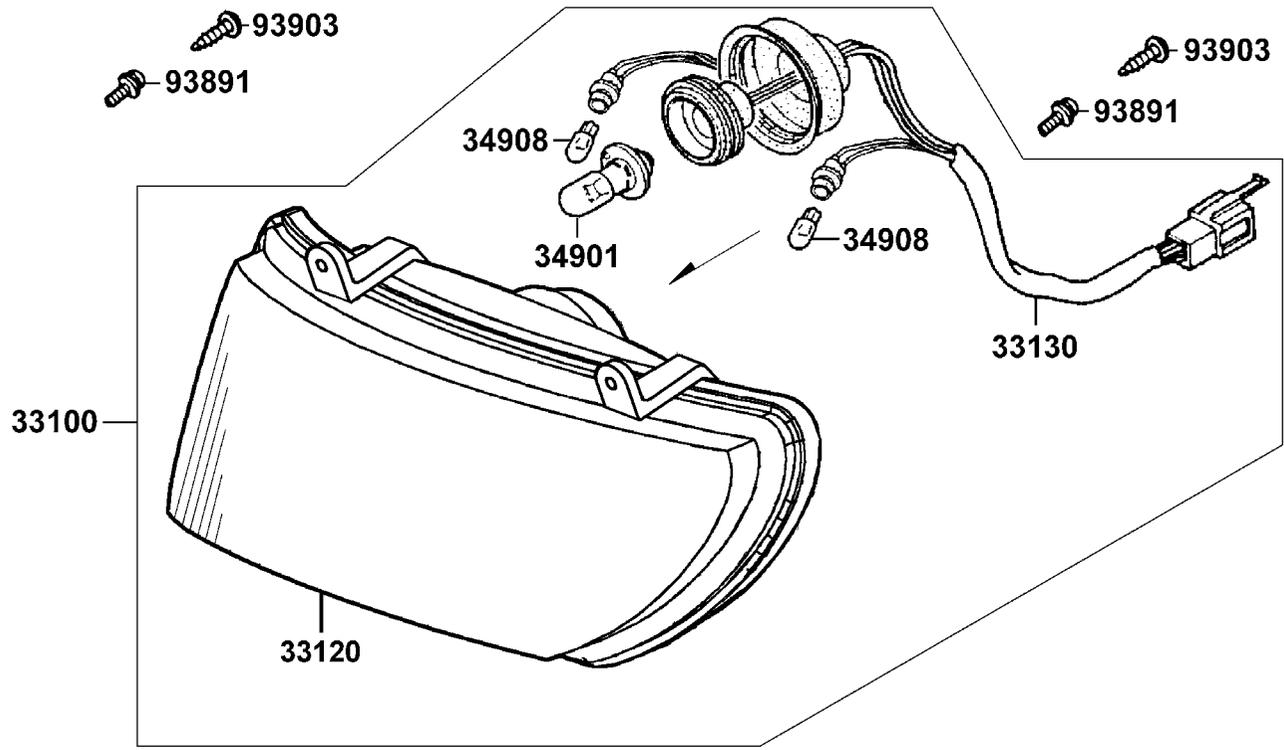

販賣記號	項目	零件號碼	版數	英文名稱	中文名稱	需要用量	參考價
Sales mark	Ref no	Part no	Ver	Description	Chinese	Regd no	Ref Price
		33100-KEC8-9000	0	LIGHT ASSY HEAD	前燈組	1	
		33120-KEC8-9000	0	UNIT HEAD LIGHT	前燈殼	1	
		33130-KEC8-9000	0	SCOKET COMP	配線組	1	
		34901-KAB-9000	0	BULB HEAD LIGHT	前燈燈泡	1	
		34908-KCU-9000	0	BULB POSITION LIGHT	位置燈燈泡	2	
		93891-05016-07	0	SCREW WASHER 5*16	螺絲 5*16	2	
		93903-25280	0	SCREW TAPPING 5*12	螺釘 5*12	2	

F 1

**F 2** Speedometer

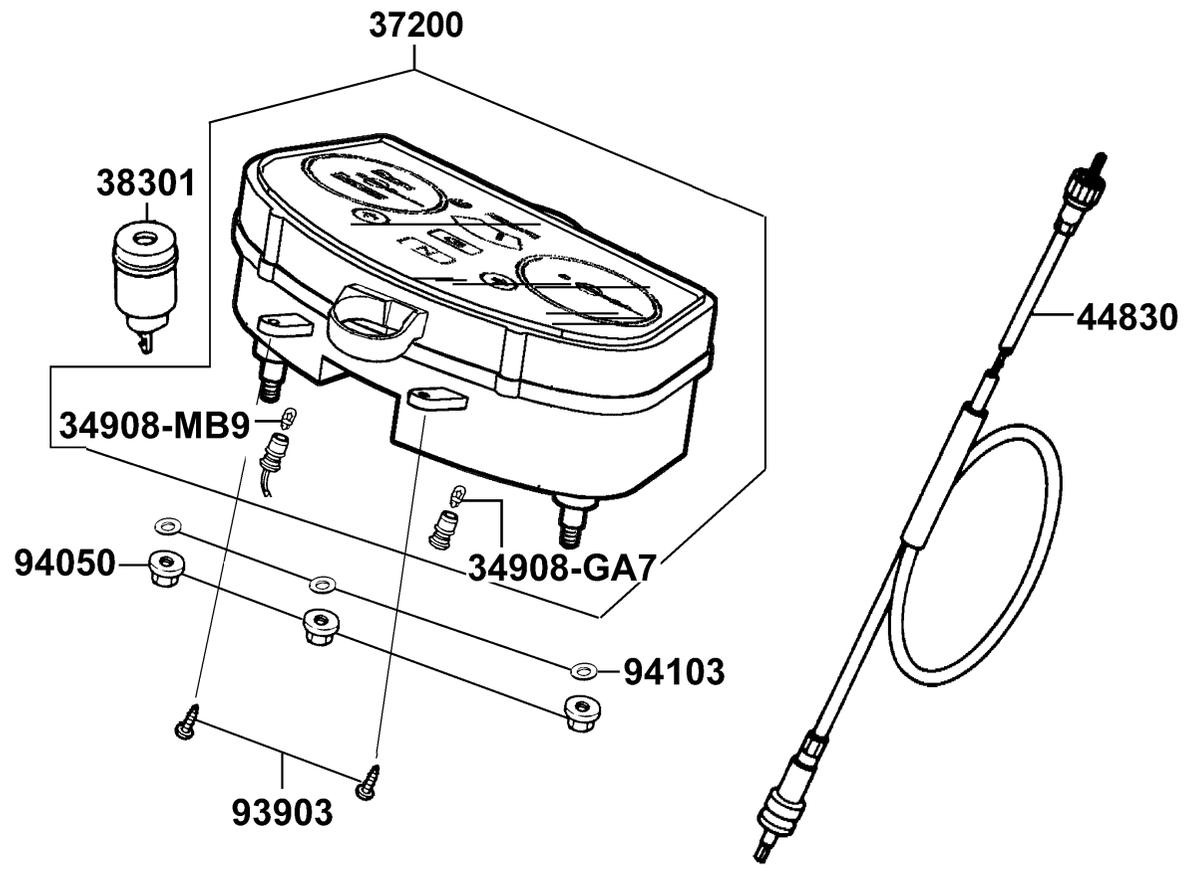

販賣記號	項目	零件號碼	版數	英文名稱	中文名稱	需要用量	參考價
Sales mark	Ref no	Part no	Ver	Description	Chinese	Regd no	Ref Price
		34908-GA7-7010-M1	1	BULB WEDGE BASE	碼錶內指示燈泡	5	
		34908-MB9-8710-M1	0	BULB WEDGE BASE	碼錶內指示燈泡	2	
		37200-KEC8-9000	2	METER ASSY SPEED	速度錶組	1	
		38301-GW0-9010	0	RELAY COMP AP WINKER	方向燈繼電器	1	
		44830-KEC8-9000	4	CABLE ASSY SPDMT	速度錶導線	1	
		93903-34480	0	SCREW TAPPING 4*16	螺釘 4*16	2	
		94050-06080	0	NUT FLANGE 6MM	螺帽 6MM	3	
		94103-06700	0	WASHER PLAIN 6MM	華司 6MM	3	



販賣記號	項目	零件號碼	版數	英文名稱	中文名稱	需要用量	參考價
Sales mark	Ref no	Part no	Ver	Description	Chinese	Regd no	Ref Price
		17910-KEC8-9000	1	CABLE COMP THROT	節流導線	1	
		22870-LLE3-E00	0	CABLE COMP CLUTCH	離合器導線	1	
		3515A-KEC8-9000	0	SW ASSY RH HNDL COMP	轉向手柄右開關組	1	
		3520A-KEC8-E000	1	SW ASSY LH HNDL COMP	轉向手柄左開關組	1	
		35340-GY6-9100	0	SW ASSY FR STOP	煞車燈前置開關	1	
		35340-KBN-9000	0	SW ASSY FR STOP	煞車燈前置開關組	1	
		45126-KEC8-9000	0	HOSE ASSY FR BRK	前煞車油管	1	
		45513-KAK-9010	0	CAP M/C	煞車主油缸蓋	1	
		45517-KAK-9000	0	HOLDER M/C	主油缸固定座	1	
		45517-KFA5-E000-IT	0	HOLDER HNDL BRKT	手柄固定座夾板	1	
		45530-KAK-3060	0	CYLINDER SET FR MASTER	煞車主油缸組	1	
		53140-KEC8-9000	0	GRIP COMP THROT	手柄右橡皮套組	1	
		53166-KEC8-9000	0	GRIP L HANDLE	手柄左橡皮套組	1	
		53167-KW6-9010	1	HOUSING UND THROT	節流管下固定座	1	
		53168-KW6-9010	0	HOUSING UP THROT	節流管上固定座	1	
		53172-KEC8-9000	0	BRKT HNDL L	手柄左托架	1	
**		53175-KAK-900	3	LEVER R STRG HNDL	手柄右拉桿	1	
**		53178-KEC8-900	1	LEVER L STRG HNDL	手柄左拉桿	1	
		53192-268-0010	0	BOLT WIRE ADJUST	離合器導線調整螺絲	1	
**		53227-KEC8-800	0	PROTECTOR R HANDLE	手柄右護蓋	1	





販賣記號	項目	零件號碼	版數	英文名稱	中文名稱	需要用量	參考價
Sales mark	Ref no	Part no	Ver	Description	Chinese	Regd no	Ref Price
**		53237-KEC8-800	0	PROTECTOR R HANDLE	手柄左護蓋	1	
		88110-KEC8-E000	0	MIRROR ASSY R BACK	右後視鏡	2	
		90113-KEC8-8000	0	BOLT HANDLE LEVER	手拉桿軸螺絲	2	
		90114-KEC8-8000	0	COLLAR HANDLE LEVER	手拉桿套筒	2	
		90145-MS9-6120-M1	0	OIL BOLT 10*22	油管螺絲 10*22	2	
		90302-GY6-9010	0	BOLT-WASH 5X12	螺絲 5*12	2	
		90321-315-6710	0	NUT FIXING	螺帽	1	
		90545-300-0010	2	WASHER OIL BOLT	華司	4	
		93500-04030-0G	0	SCREW PAN 4*30	螺絲 4*30	1	
		93500-04045-0G	0	SCREW PAN 4*45	螺絲 4*45	1	
		93500-05022-0G	0	SCREW PAN 5*22	螺絲 5*22	4	
		93600-04012-1A	0	SCREW FLAT 4*12	螺絲 4*12	2	
		93893-04012-18	0	SCREW WASHER 4*12	螺絲 4*12	1	
		94050-06080	0	NUT FLANGE 6MM	螺帽 6MM	2	
		96001-06020-02	0	BOLT FLANGE SH 6*20	螺絲 6*20	4	

F 3

**F 4 Handle Steering●Stem**

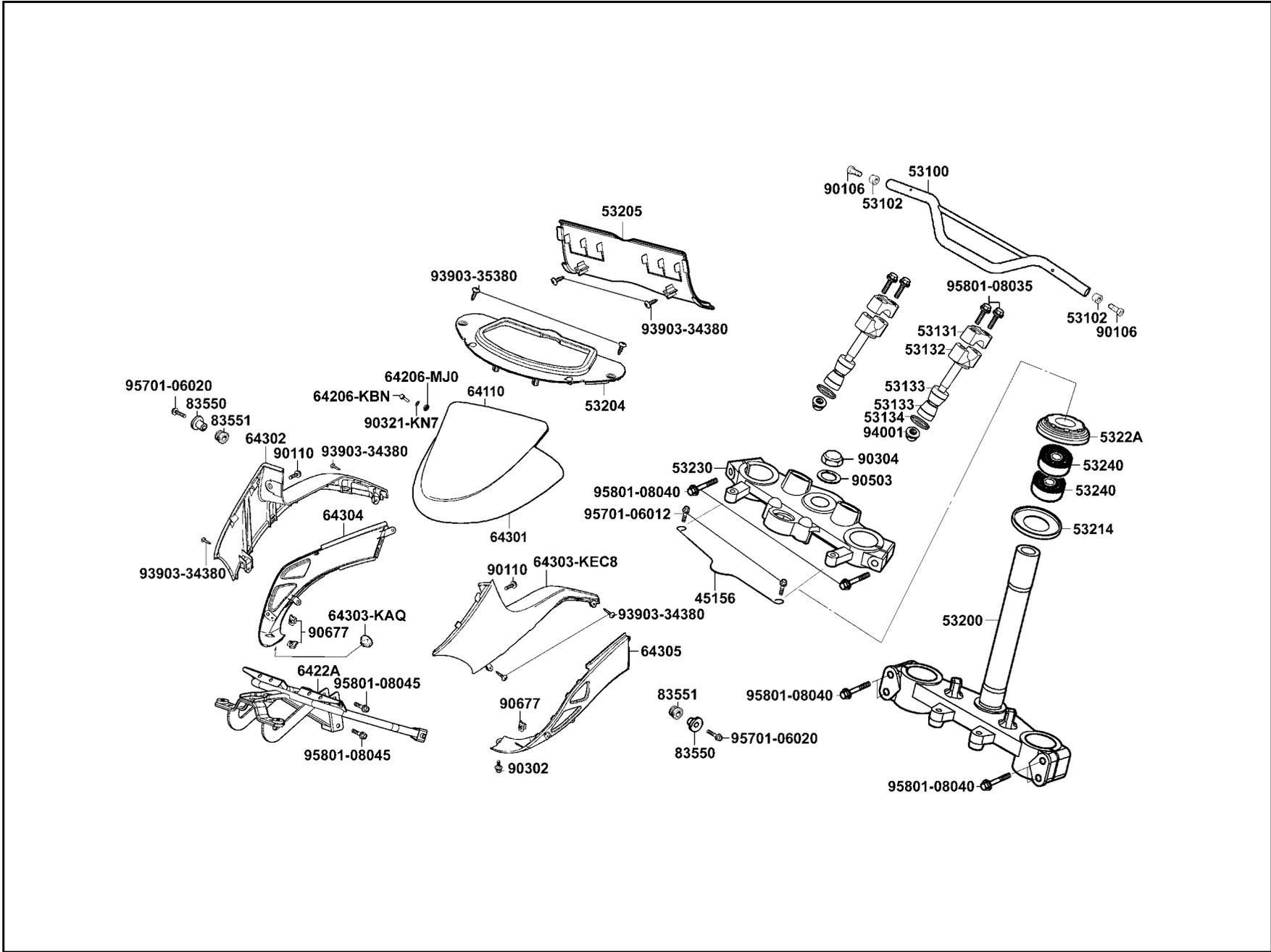

販賣記號	項目	零件號碼	版數	英文名稱	中文名稱	需要用量	參考價
Sales mark	Ref no	Part no	Ver	Description	Chinese	Regd no	Ref Price
		45156-KEC8-9000	0	CLAMPER HOSE	油管夾	1	
		53100-KEC8-9000	0	PIPE COMP HANDLE STRG	轉向手柄	1	
		53102-KEC8-9000	0	END HANDLE	平衡端子	2	
		53131-439-0010	0	HOLDER HANDLE PIPE	手柄上固定座	2	
		53132-439-0000	0	HOLDER UNDER HNDL PIPE	手柄下固定座	2	
		53133-236-0000	0	RUBBER HANDLE CUSHION	橡皮	4	
		53134-283-0010	0	HANDLE CUSHION WASHER	華司	2	
		53200-KEC8-9000	0	STEM COMP STEERING	轉向桿	1	
		53204-KEC8-9000	0	COVER METER	碼錶蓋	1	
		53205-KEC8-9000	0	DHROUD METER	碼錶導板	1	
		53214-KEC8-9000-M1	0	DUST SEAL STEM BOT	墊片	1	
		5322A-KEC8-9000	0	THREAD STRG STEM	轉向桿頂螺帽	1	
		53230-KEC8-9000	0	BRIDGE FORK TOP	前避震器頂樑	1	
		53240-KEC8-9000	0	BEARING TAPER ROLLER ET-32005X	套筒	2	
		64110-KEC8-9000	0	WINDSCREEN	遮陽板	1	
		64206-KBN-9000	0	PIN SCREEN SET	鉚銷	6	
		64206-MJ0-0010	0	NUT SPEED 4MM	螺帽 4MM	6	
		6422A-KEC8-9000	0	STAY ASSY FR COWL	前罩支架	1	
**		64301-KEC8-900	0	COVER UPPER FR	前上蓋	1	
**		64302-KEC8-900	0	COVER R FR	右前蓋	1	

**F 4 Handle Steering●Stem**

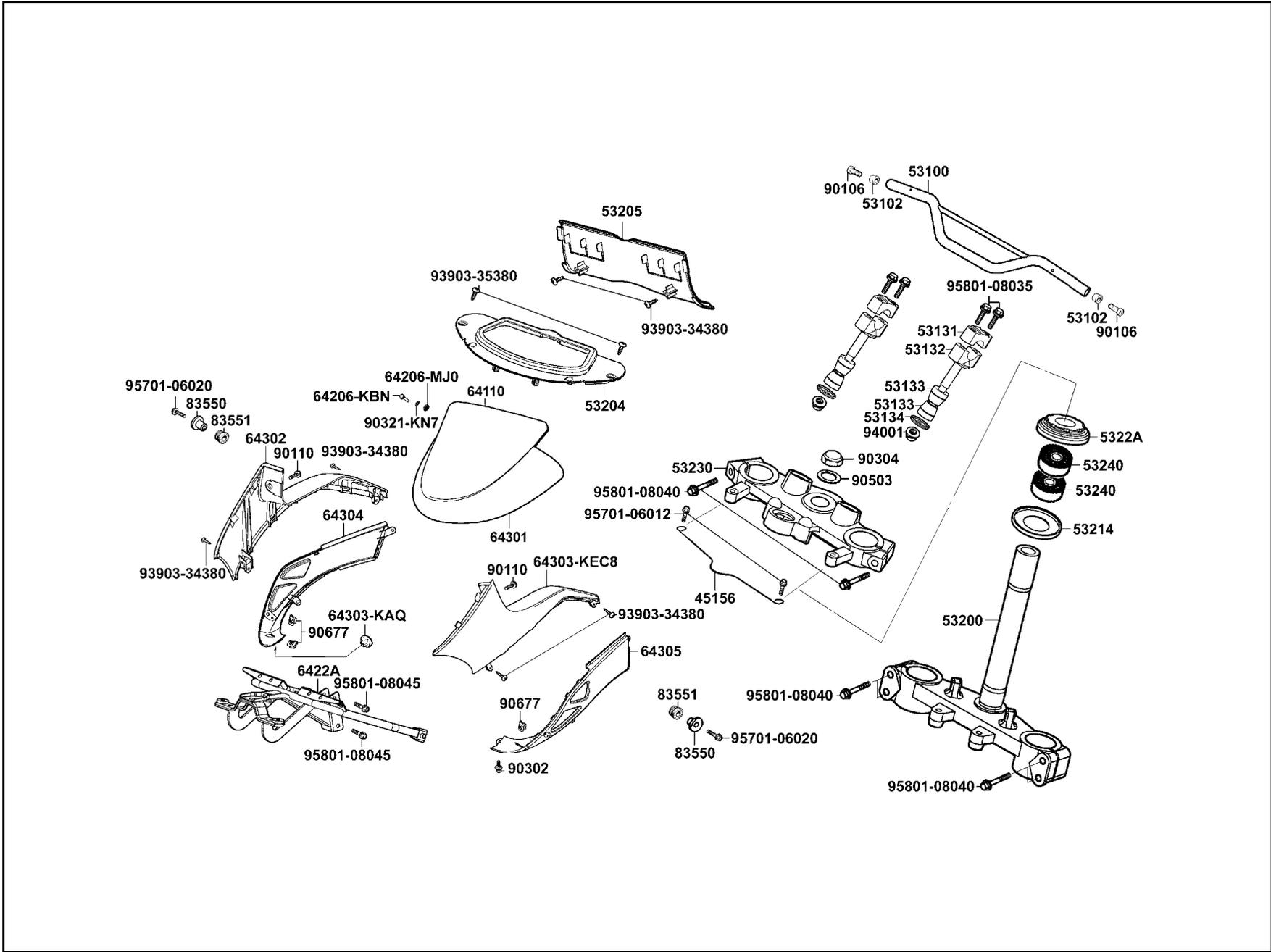

販賣記號	項目	零件號碼	版數	英文名稱	中文名稱	需要用量	參考價
Sales mark	Ref no	Part no	Ver	Description	Chinese	Regd no	Ref Price
		64303-KAQ-9000	0	CAP FR MOLDING	蓋子	1	
**		64303-KEC8-900	0	COVER L FR	左前蓋	1	
**		64304-KEC8-900	0	COVER R SIDE	右邊蓋	1	
**		64305-KEC8-900	0	COVER L SIDE	左邊蓋	1	
		83550-KEC8-9000	0	COLLAR	套筒	2	
		83551-KEC8-9000	0	GROMMET COVER	邊蓋固定扣環	2	
		90106-KFC2-9000	0	BOLT WASH 8MM	螺絲 8MM	2	
		90110-KEB7-9000	0	SCREW SPECIAL 6*14	螺絲 6*14	2	
		90302-KEC8-9000	0	BOLT PAN 5*9	螺絲 5*9	1	
		90304-KAK-9000	1	NUT STRG STEM	螺帽	1	
		90321-KN7-9110	0	WASHER EMBLEM	華司	6	
		90503-051-8700	0	WASHER STEERING STEM NUT	鎖華司	1	
		90677-GR1-0030	1	NUT CLIP 5MM	螺帽夾 5MM	3	
		93903-34380	0	SCREW TAPPING 4*12	螺釘 4*12	6	
		93903-35380	0	SCREW TAPPING 5*16	螺釘 5*16	2	
		94001-10080-0S	0	NUT HEX 10MM	螺帽 10MM	2	
		95701-06012-08	0	BOLT FLANGE 6*12	螺絲 6*12	2	
		95701-06020-08	0	BOLT FLANGE 6*20	螺絲 6*20	2	
		95801-08035-08	0	BOLT FLANGE 8*35	螺絲 8*35	4	
		95801-08040-08	0	BOLT FLANGE 8*40	螺絲 8*40	6	

F 4

**F 4 Handle Steering Stem**

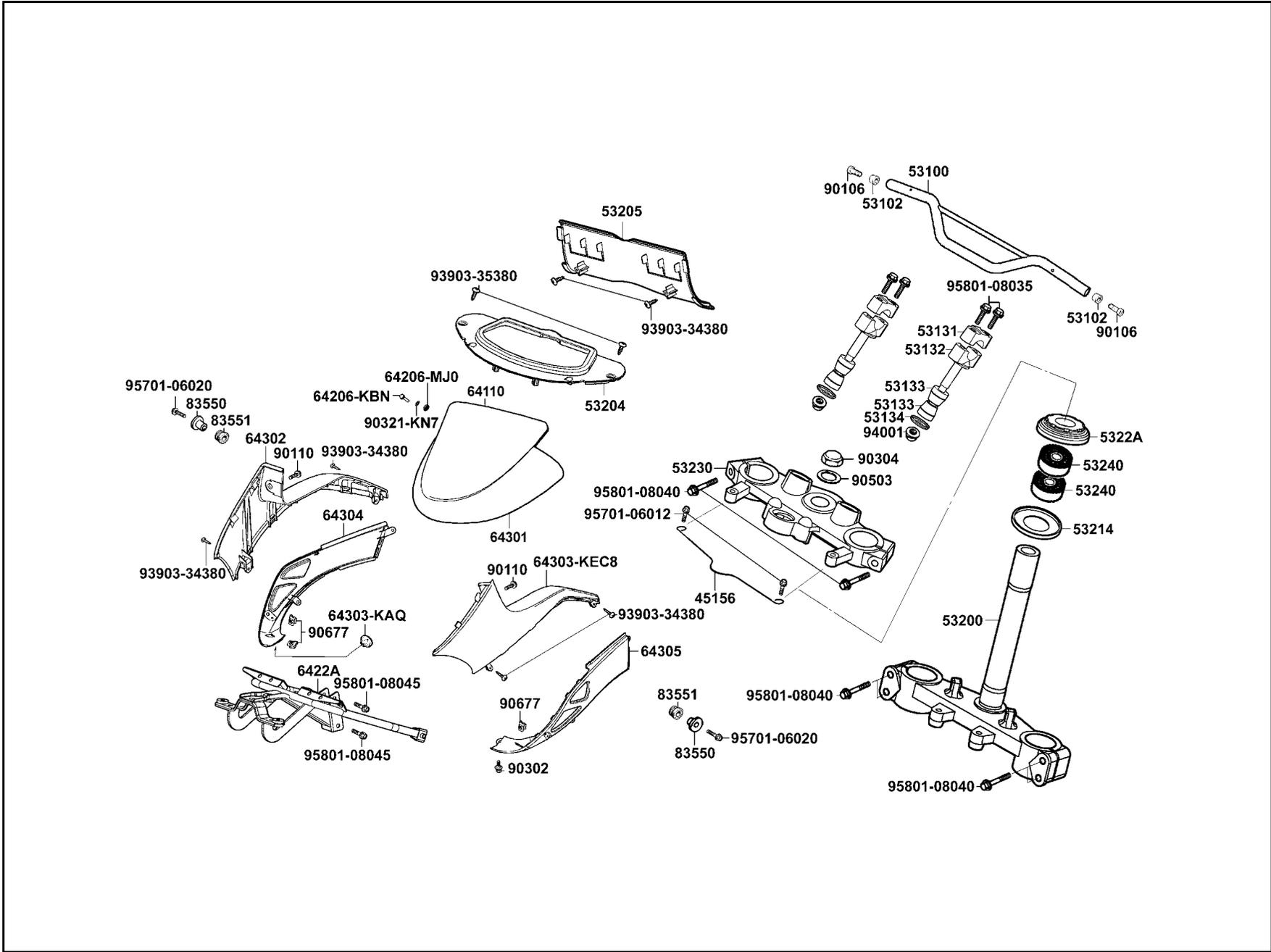

販賣記號	項目	零件號碼	版數	英文名稱	中文名稱	需要用量	參考價
Sales mark	Ref no	Part no	Ver	Description	Chinese	Regd no	Ref Price
		95801-08045-07	0	BOLT FLANGE 8*45	螺絲 8*45	2	

F 4

**F 5** Front Fender

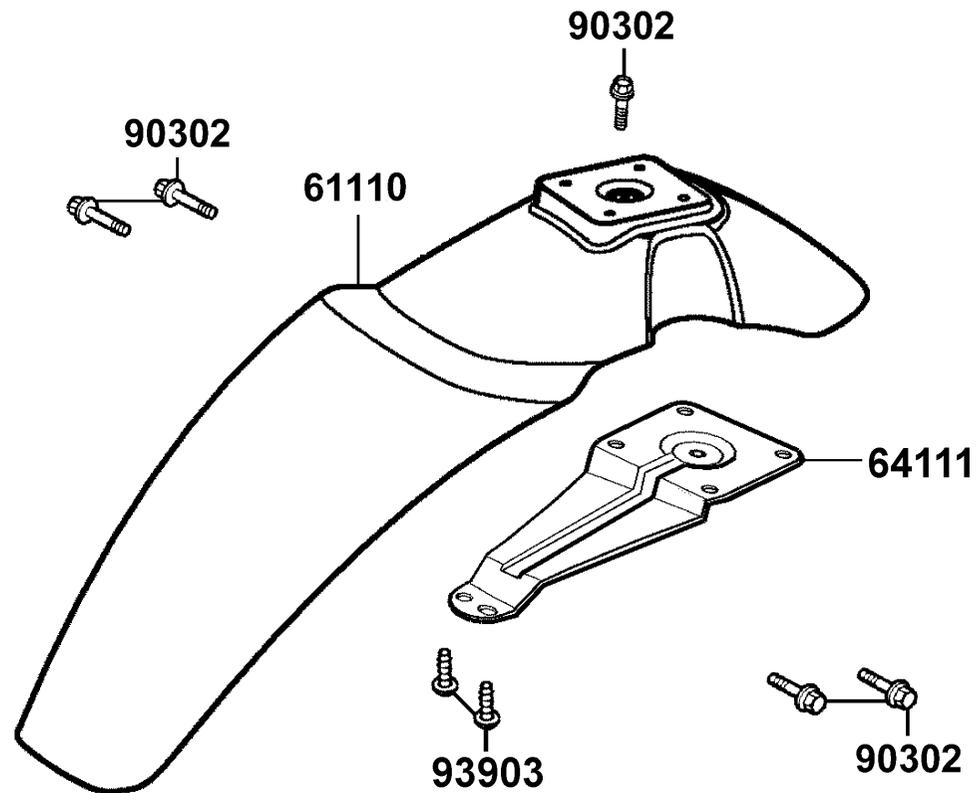



**F 5**

販賣記號	項目	零件號碼	版數	英文名稱	中文名稱	需要用量	參考價
Sales mark	Ref no	Part no	Ver	Description	Chinese	Regd no	Ref Price
**		61110-KEC8-800	0	FENDER FR	前土除	1	
		64111-KEC8-9000	0	STAY FR FENDER	前土除支架	1	
		90302-GY6-9400	0	BOLT-WASH 5*16	螺絲 5*16	5	
		93903-25280	0	SCREW TAPPING 5*12	螺釘 5*12	2	

**F 6** Front Fork

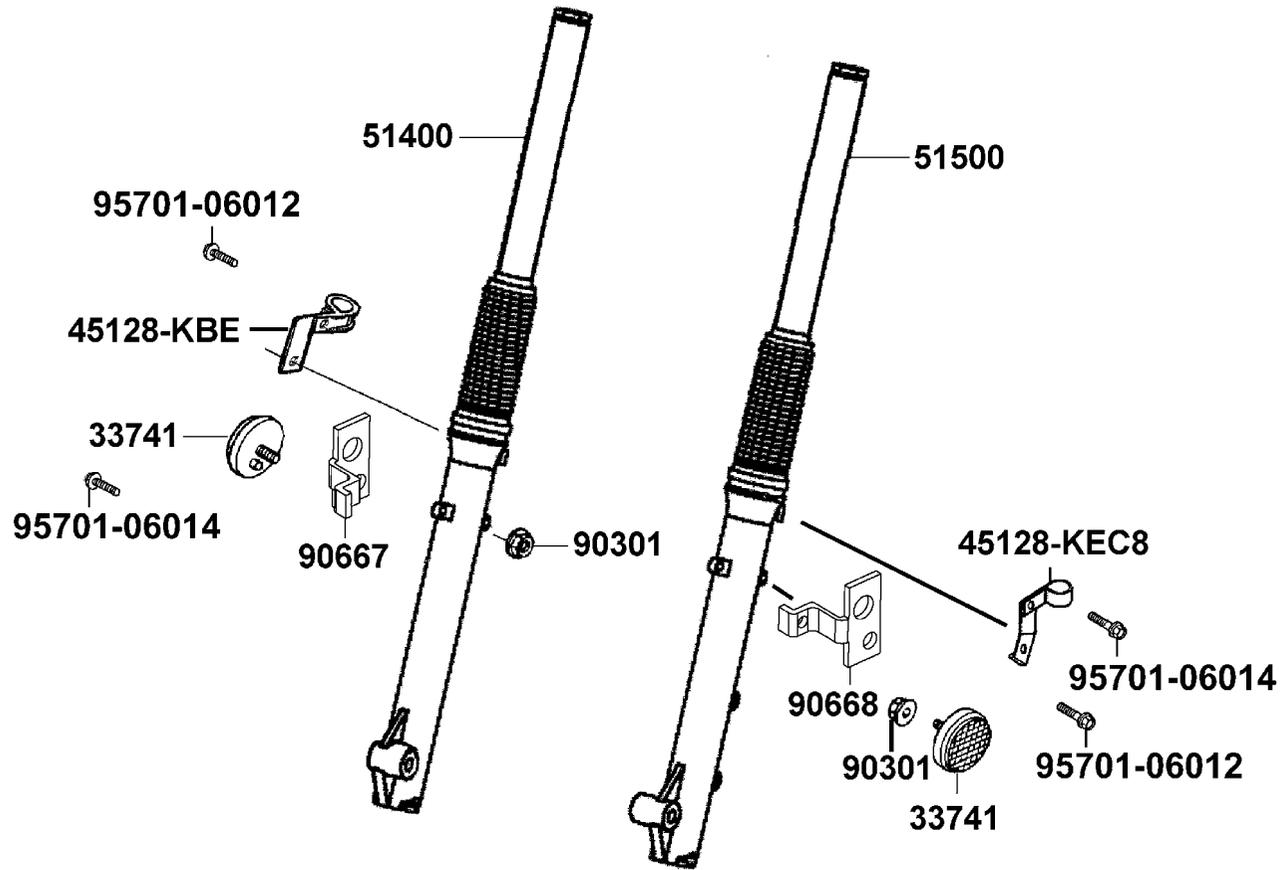

販賣記號	項目	零件號碼	版數	英文名稱	中文名稱	需要用量	參考價
Sales mark	Ref no	Part no	Ver	Description	Chinese	Regd no	Ref Price
		33741-GY6-C300	1	REFLEX REFLECTOR	反光片	2	
		45128-KBE-9000	0	CLAMPER FR BRAKE HOSE	前煞車油管夾	1	
		45128-KEC8-9000	0	CLAMPER FR BRAKE HOSE	前煞車油管夾	1	
		51400-KEC8-9000	3	FORK ASSY R FR	右前避震器	1	
		51500-KEC8-9000	3	FORK ASSY L FR	左前避震器	1	
		90301-634-6700	0	NUT FLANGE 6MM	螺帽 6MM	2	
		90667-KEC8-9000	0	STAY SIDE REFLECTOR R	右反光片座	1	
		90668-KEC8-9000	0	STAY SIDE REFLECTOR L	左反光片座	1	
		95701-06012-08	0	BOLT FLANGE 6*12	螺絲 6*12	2	
		95701-06014-08	0	BOLT FLANGE 6*14	螺絲 6*14	2	

F 6

**F 7 Front Caliper**

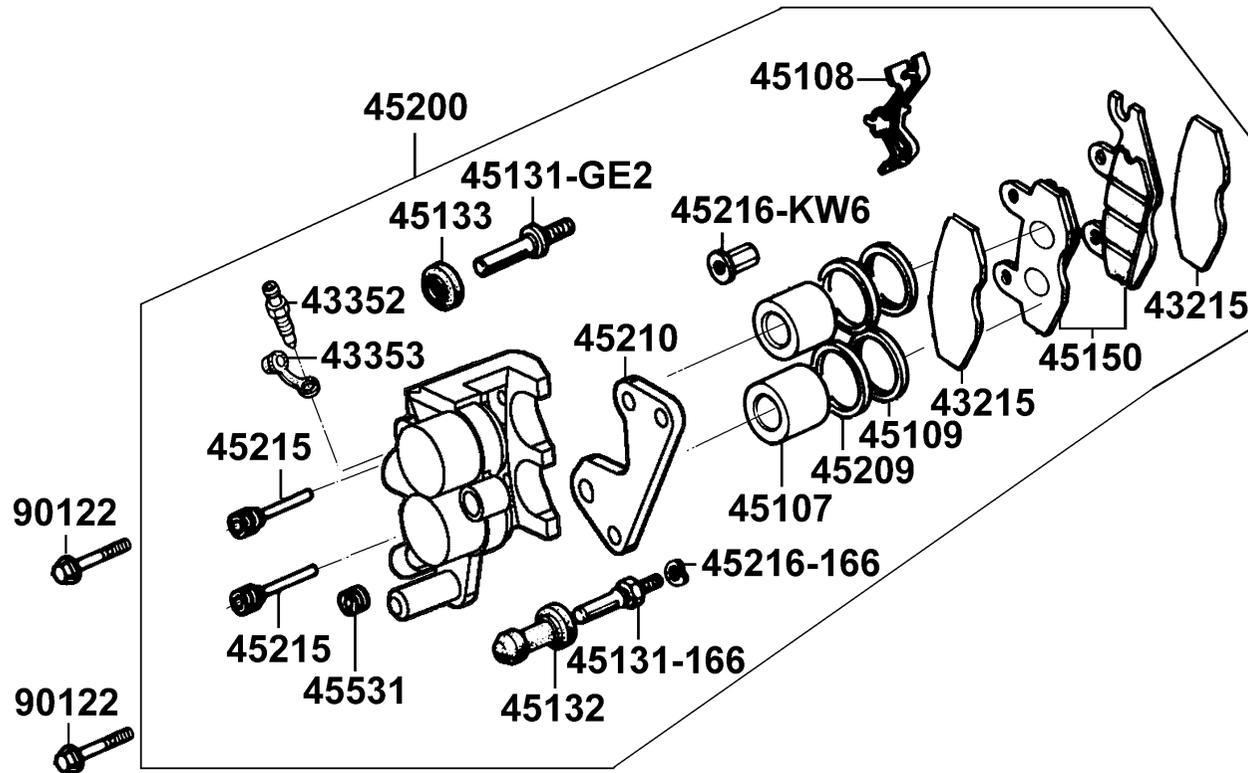

F 7

販賣記號	項目	零件號碼	版數	英文名稱	中文名稱	需要用量	參考價
Sales mark	Ref no	Part no	Ver	Description	Chinese	Regd no	Ref Price
		43215-KBE-9000	0	PAD HANGER	吊架摩擦板	2	
		43352-568-0030	3	SCREW BLEEDER	加油嘴	1	
		43353-461-7710-M1	0	CAP BLEEDER	加油嘴蓋	1	
		45107-MN5-0070	0	PISTON	卡鉗活塞	2	
		45108-ML4-0060	2	PAD SPG	摩擦板彈簧	1	
		45109-GE2-0060	0	DUST SEAL	塵封	2	
		45131-166-0160	0	PIN BOLT	螺絲銷	1	
		45131-GE2-0060	1	PIN BOLT A	螺絲銷 A	1	
		45132-166-0160	0	BUSH BOOT PIN	襯套	1	
		45133-MA3-0060	0	BOOT B	襯套 B	1	
		45150-KEC8-3050	0	PAD ASSY	煞車摩擦板組	1	
**		45200-KEC8-900	0	CALIPER ASSY FR	前煞車卡鉗	1	
		45209-GE2-0060	0	SEAL PISTON	油封	2	
		45210-KEC8-9000	0	BRACKET FR CALIPER	前煞車卡鉗托架	1	
		45215-KCE-9000	0	PIN HANGER	吊架銷	2	
		45216-166-0060	0	WASHER WAVE	華司	1	
		45216-KW6-9020-M1	0	TORQUE NUT	螺帽	1	
		45531-GR1-9510	0	PLUG	塞蓋	1	
		90122-KHC7-C000-ZF	0	BOLT FLANGE 8*38	螺絲 8*38	2	

**F 8 Front Wheel**

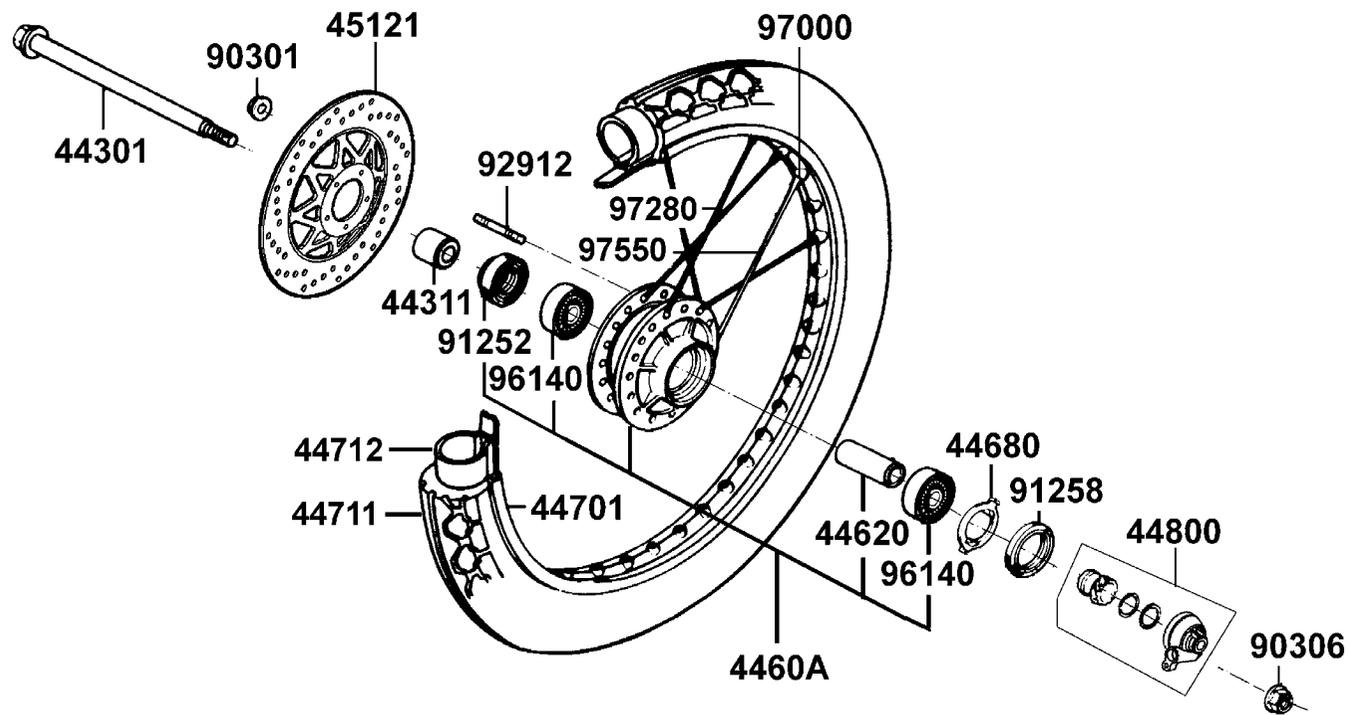

販賣記號	項目	零件號碼	版數	英文名稱	中文名稱	需要用量	參考價
Sales mark	Ref no	Part no	Ver	Description	Chinese	Regd no	Ref Price
		44301-KHB4-9000	0	AXLE FR WHEEL	前輪軸	1	
		44311-KAK-9000	0	COLLAR FR SIDE WHEEL	前輪邊套筒	1	
		4460A-KEC8-8000	0	HUB SET FR WHEEL	前輪殼組	1	
		44620-400-0000	1	COLLAR FR DIST	前輪邊套筒	1	
		44680-410-0010	0	RETAINER GEAR BOX	速度齒輪箱承盤	1	
		44701-KEC8-8000	0	RIM FRONT WHELL	前輪鋼圈	1	
		44711-KEC8-80B	0	TIRE FR	前輪外胎	1	
		44712-KEC8-80B	0	TUBE TIRE	前輪內胎	1	
		44800-KEC8-800	1	GEAR BOX ASSY SPDMT	速度齒輪箱組	1	
		45121-KW6-9010	2	DISK FRONT BRAKE	煞車摩擦圓盤	1	
		90301-473-0040	0	NUT U 6MM	螺帽 6MM	5	
		90306-KF0-901	0	NUT FLANGE 12MM	螺帽 12MM	1	
		91252-030-0000	0	OIL SEAL WHEEL 23*37*7	油封 23*37*7	1	
		91258-410-0000-M2	0	DUST SEAL 40*50*5	防塵封 40*50*5	1	
		92912-06018-0E	0	BOLT STUD II 6*18	雙頭螺絲 6*18	5	
		96140-63010-10	0	BEARING BALL RADIAL 6301	軸承 6301	2	
		97000-56200	0	NIPPLE SPOKE 9	鋼絲接頭	36	
		97280-51270-10	0	SPOKE A FRONT 9*215	鋼絲	18	
		97550-51269-10	0	SPOKE B FRONT 9*214.5	鋼絲	18	

**F 9** Rear Brake Panel

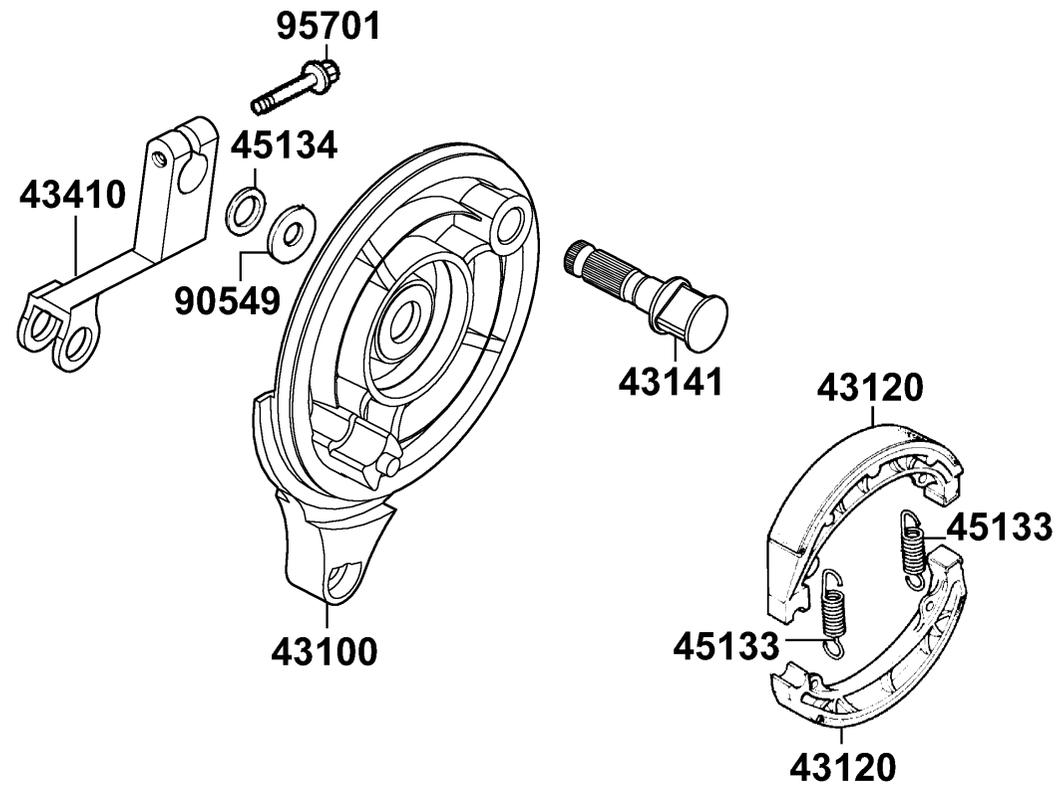



販賣記號	項目	零件號碼	版數	英文名稱	中文名稱	需要用量	參考價
Sales mark	Ref no	Part no	Ver	Description	Chinese	Regd no	Ref Price
		43100-KG7-8320	0	PANEL COMP REAR BRAKE	後煞車板	1	
		43120-KG7-0020	3	SHOE COMP REAR BRAKE	後煞車鞋	2	
		43141-KEC8-9000	0	CAM REAR BRAKE	後煞車凸輪	1	
		43410-KEC8-9000	0	ARM RR BRAKE	後煞車臂	1	
		45133-240-0000	1	SPRING FRONT BRAKE SHOE	煞車鞋彈簧	2	
		45134-250-0000	0	BRAKE CAM DUST SEAL	凸輪防塵封	1	
		90549-121-0000	0	WASHER PLAIN 14M/M	華司 14MM	1	
		95701-06022-08	0	BOLT FLANGE 6*22	螺絲 6*22	1	

**F 10** Rear Wheel

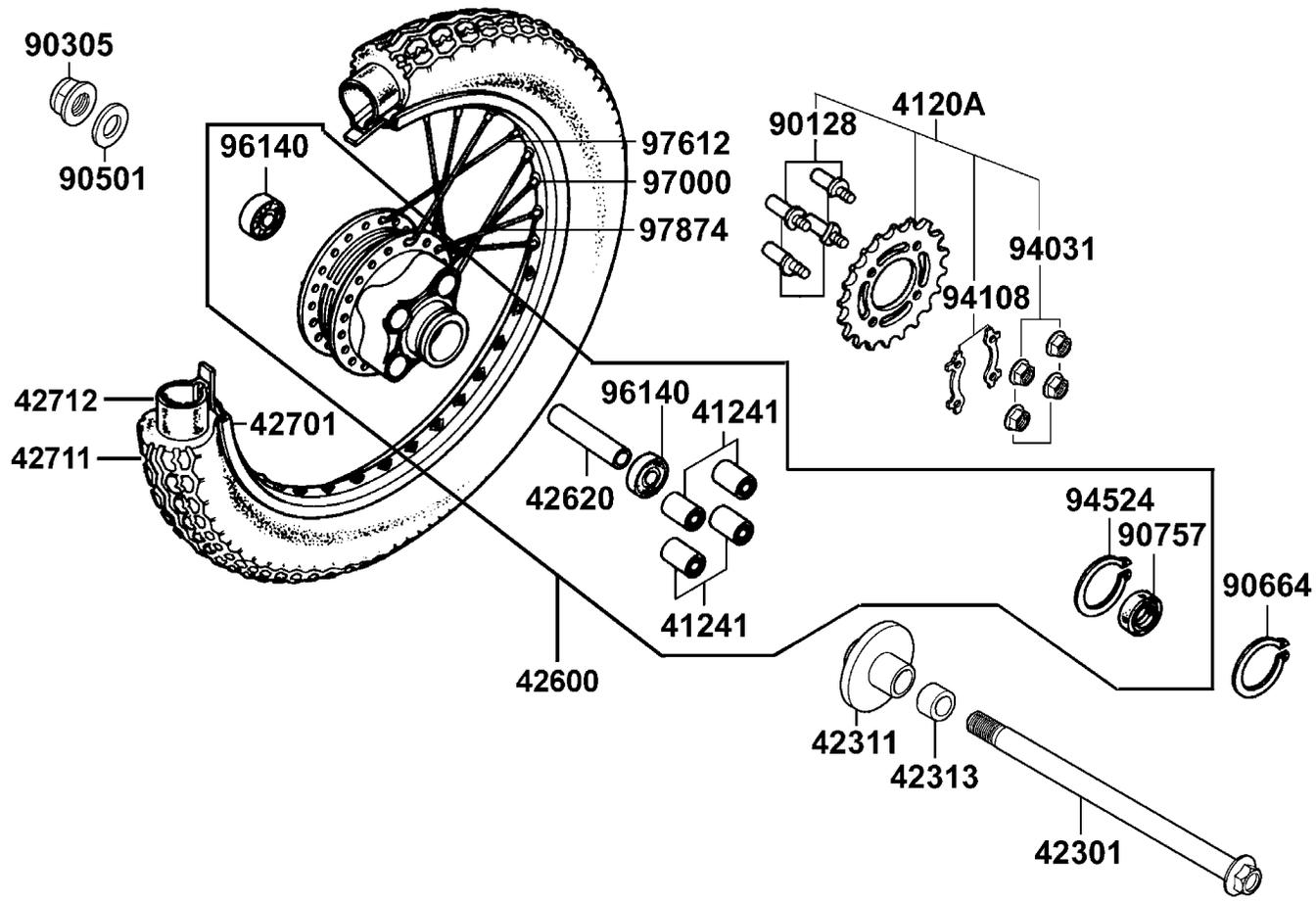

販賣記號	項目	零件號碼	版數	英文名稱	中文名稱	需要用量	參考價
Sales mark	Ref no	Part no	Ver	Description	Chinese	Regd no	Ref Price
		4120A-KEC8-9000	0	SPROCKET ASSY FINAL (46T)	後齒輪組	1	
		41241-307-0110	0	BUSH RR WHEEL DAMPER	後輪襯套	4	
		42301-KEC8-900	2	AXLE REAR WHEEL	後輪軸	1	
		42311-KEC8-9000	0	COLLAR RR WHEEL L	後輪左套筒	1	
		42313-KEC8-9000	0	COLLAR RR WHEEL R	後輪右套筒	1	
		42600-KEC8-3050	0	HUB SET RR WHEEL	後輪殼組	1	
		42620-KEC2-9000	0	COLLAR REAR AXLE DISTANCE	後輪軸套筒	1	
		42701-KEC8-8000	0	RIM REAR WHEEL	後輪鋼圈	1	
		42711-KEC8-80B	0	TIRE RR	後輪外胎	1	
		42712-KEC8-80B	0	TUBE TIRE	後輪內胎	1	
		90128-KEC8-9000	0	PIN SPRKT FIX	齒輪盤固定銷	4	
		90305-KW6-9120-M1	0	NUT U FLANGE 16MM	螺帽 16MM	1	
		90501-KBN-9010	0	WASHER 16MM	華司 16MM	1	
		90664-216-9000	0	CIR CLIP 58MM	環夾 58MM	1	
		90757-439-9310	0	DUST SEAL REAR WHEEL	油封	1	
		94031-10080	0	NUT HEX 10MM	螺帽 10MM	4	
		94108-KEC8-9000	0	WASHER TONGUED 10MM	牙型華司	2	
		94524-47000	0	CIR CLIP IN 47	夾子 47MM	1	
		96140-63030-10	0	BEARING BALL RADIAL 6303	軸承 6303	2	
		97000-56200	0	NIPPLE SPOKE 9	鋼絲接頭	36	

F 10

**F 10** Rear Wheel

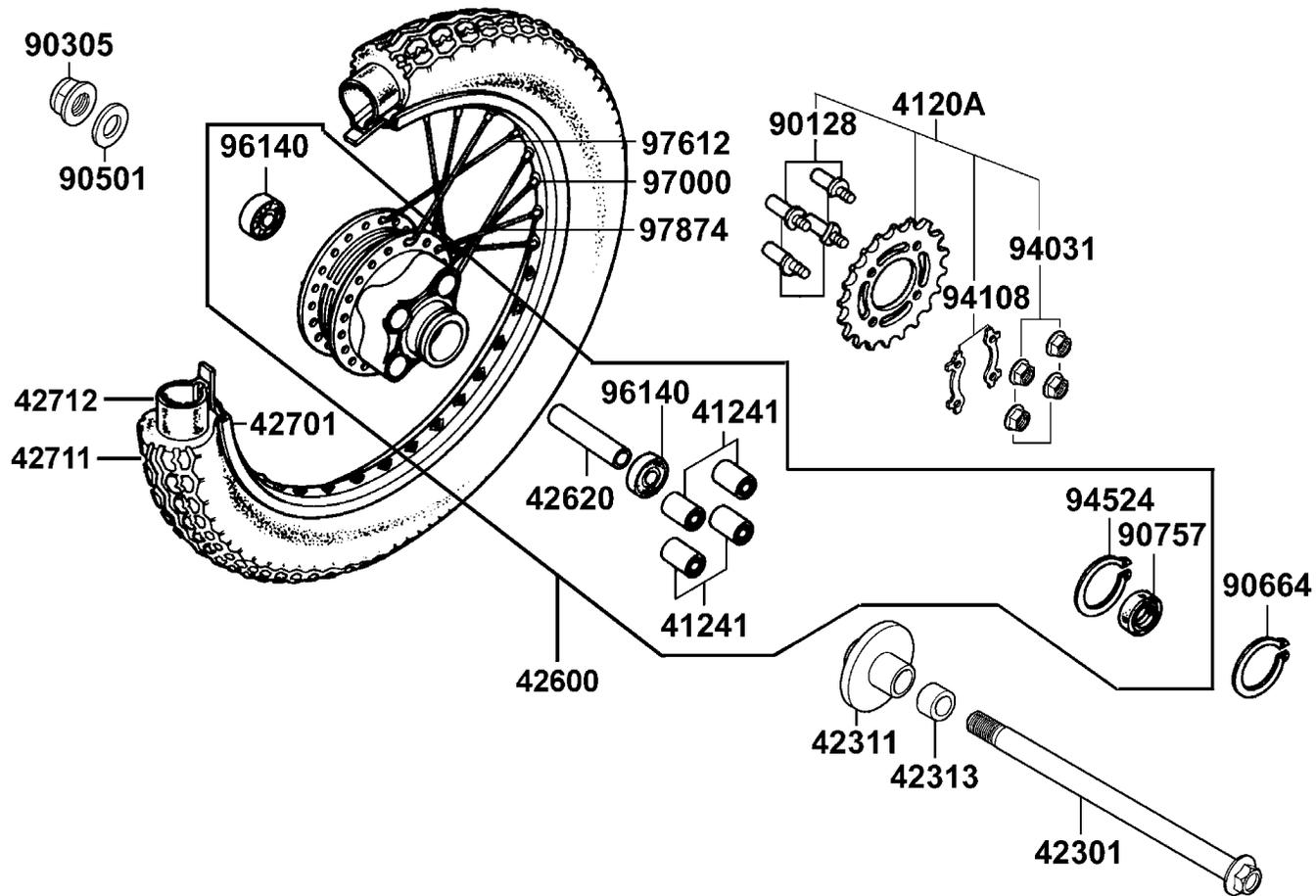

販賣記號	項目	零件號碼	版數	英文名稱	中文名稱	需要用量	參考價
Sales mark	Ref no	Part no	Ver	Description	Chinese	Regd no	Ref Price
		97612-62130-10	0	SPOKE B8*145	鋼絲	18	
		97874-62129-10	0	SPOKE B8*144.5	鋼絲	18	

F 10

**F 11 Fuel Tank**

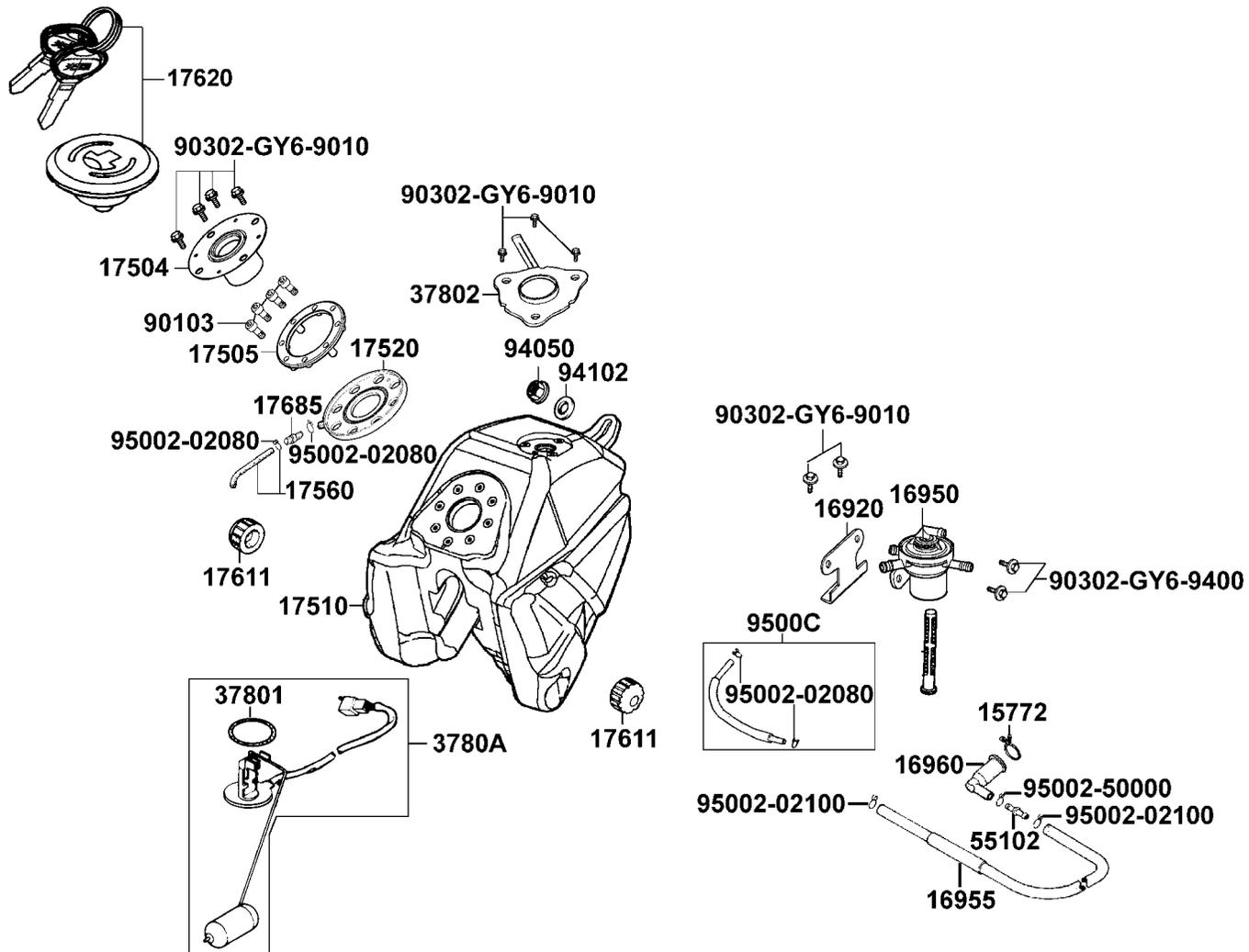

販賣記號	項目	零件號碼	版數	英文名稱	中文名稱	需要用量	參考價
Sales mark	Ref no	Part no	Ver	Description	Chinese	Regd no	Ref Price
		15772-551-0000	1	CLIP BREATHER TUBE	油管夾	1	
		16920-KEC8-8000	0	STAY AUTO COCK	油杯座	1	
		16950-KEC8-9000	3	AUTO COCK ASSY FUEL	油杯	1	
		16955-KEC8-9000	0	TUBE ASSY FUEL	油管組	1	
		16960-KEC8-9000	0	JOINT FUEL STRN	油杯護套	1	
		17504-KEC8-E000	1	FILLER COMP FUEL	加油漏斗	1	
		17505-KEC8-9000	0	RING COMP CAP HOUSING	托蓋固定座	1	
		17510-KEC8-E000	2	TANK COMP FUEL	油箱組	1	
		17520-KEC8-9000	0	PACKING FUEL TANK	油箱蓋托蓋	1	
		17560-KEC8-900	0	TUBE FUEL TRAY	油管	1	
		17611-286-0010	0	CUSHION FRONT FUEL TANK	油箱減震橡皮	2	
		17620-KEC8-3250	0	CAP SET FUEL FILLER	油箱蓋組	1	
		17685-GY6-9400	0	JOINT COCK-CARB TUBE	油管接頭	1	
		37801-GA7-7000	1	PACKING BASE	油封	1	
		37802-KEC8-9000	0	RET FUEL UNIT	浮筒計承座	1	
		3780A-KEC8-9000	0	FUEL UNIT ASSY	燃料量指示器組	1	
		55102-166-0010	0	JOINT OIL TUBE	油管接頭	1	
		90103-KEC8-9000	0	SOCKET BOLT 5*25	螺絲 5*25	4	
		90302-GY6-9010	0	BOLT-WASH 5*12	螺絲 5*12	9	
		90302-GY6-9400	0	BOLT-WASH 5*16	螺絲 5*16	2	

F 11

**F 11 Fuel Tank**

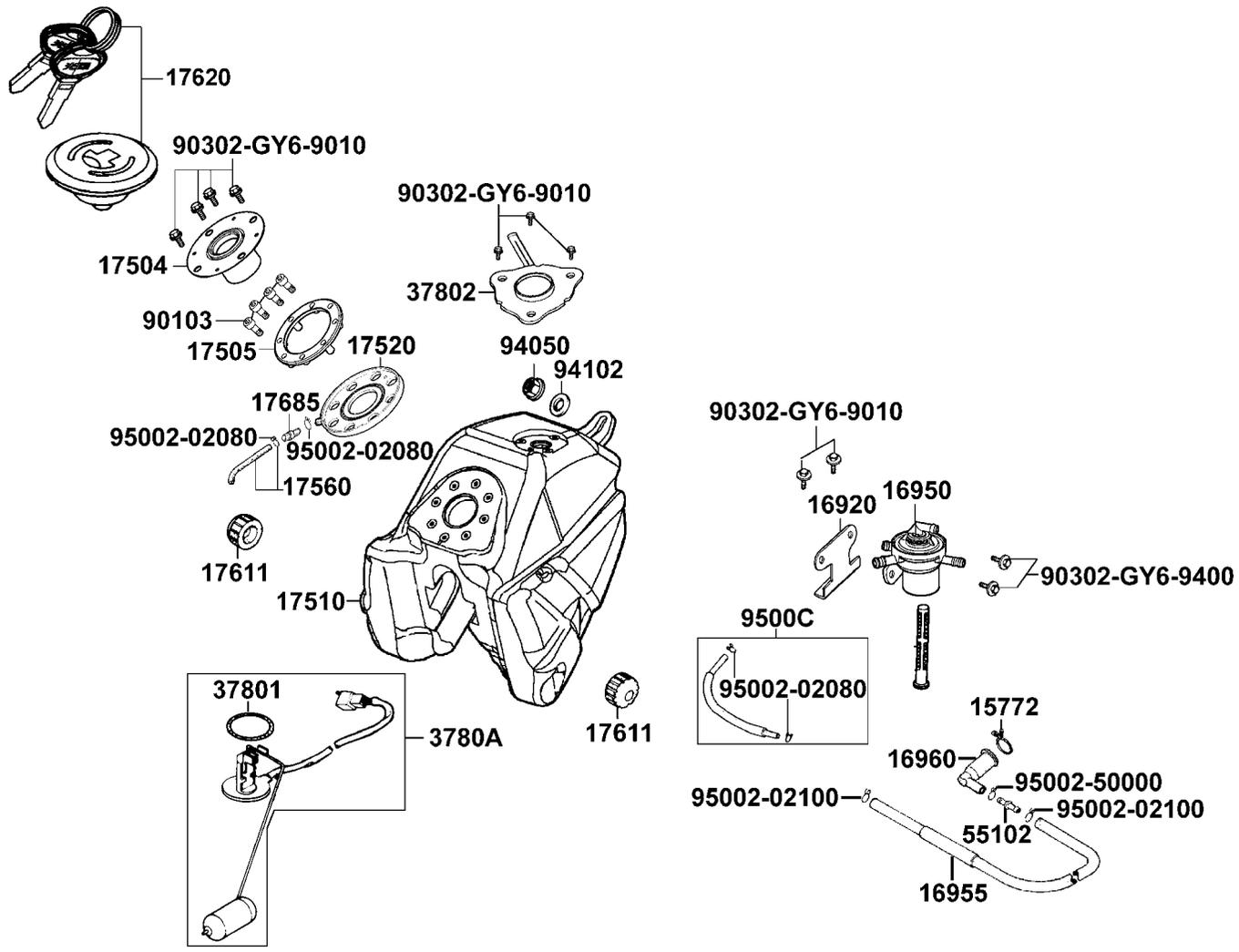



販賣記號	項目	零件號碼	版數	英文名稱	中文名稱	需要用量	參考價
Sales mark	Ref no	Part no	Ver	Description	Chinese	Regd no	Ref Price
		94050-08080	0	NUT FLANGE 8MM	螺帽 8MM	1	
		94102-14800	0	WASHER PLAIN 14MM	華司 14MM	1	
		95002-02080	0	CLIP B8 TUBE	管夾	4	
		95002-02100	0	CLIP B10 TUBE	油管夾	2	
		95002-50000	0	CLIP C9 TUBE	油管夾	1	
		9500C-KEC8-9000	0	TUBE ASSY FUEL	油管組	1	

F 11

**F 12** Seat

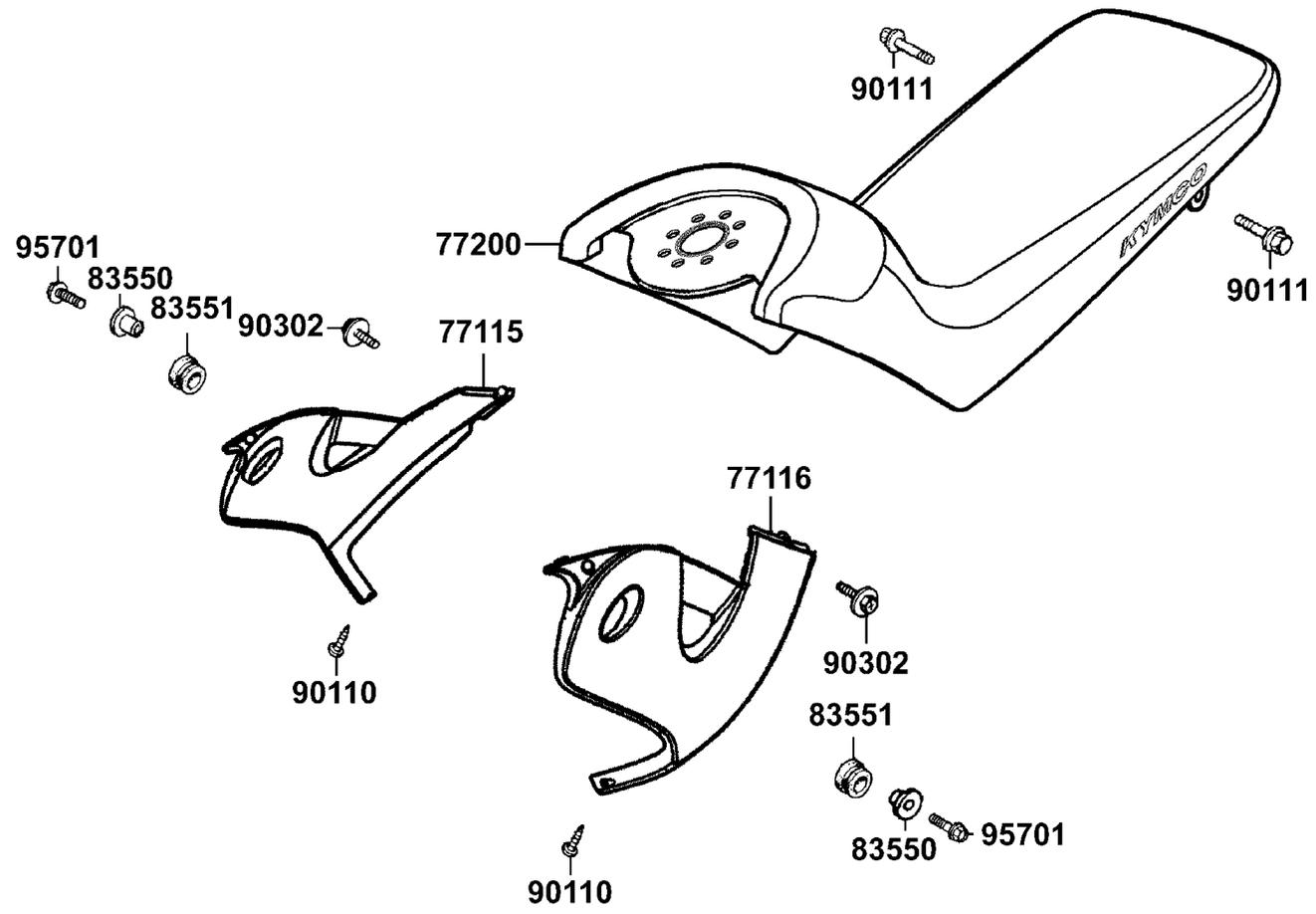

販賣記號	項目	零件號碼	版數	英文名稱	中文名稱	需要用量	參考價
Sales mark	Ref no	Part no	Ver	Description	Chinese	Regd no	Ref Price
**		77115-LLE2-305	0	COWL SET R UNDER	右下擋泥板	1	
**		77116-LLE2-305	0	COWL SET L UNDER	左下擋泥板	1	
**		77200-KEC8-900	0	SEAT ASST	座墊	1	
		83550-KEC8-9000	0	COLLAR	套筒	2	
		83551-KEC8-9000	0	GROMMET COVER	索環	2	
		90110-GW0-0010	0	SCREW SPECIAL 6*14	螺絲 6*14	2	
		90111-KEC8-9000	0	BOLT FLANGE 6MM	螺絲 6MM	2	
		90302-KEC8-9000	0	BOLT PAN 5*9	螺絲 5*9	2	
		95701-06020-08	0	BOLT FLANGE 6*20	螺絲 6*20	2	

**F 13** Side Cover

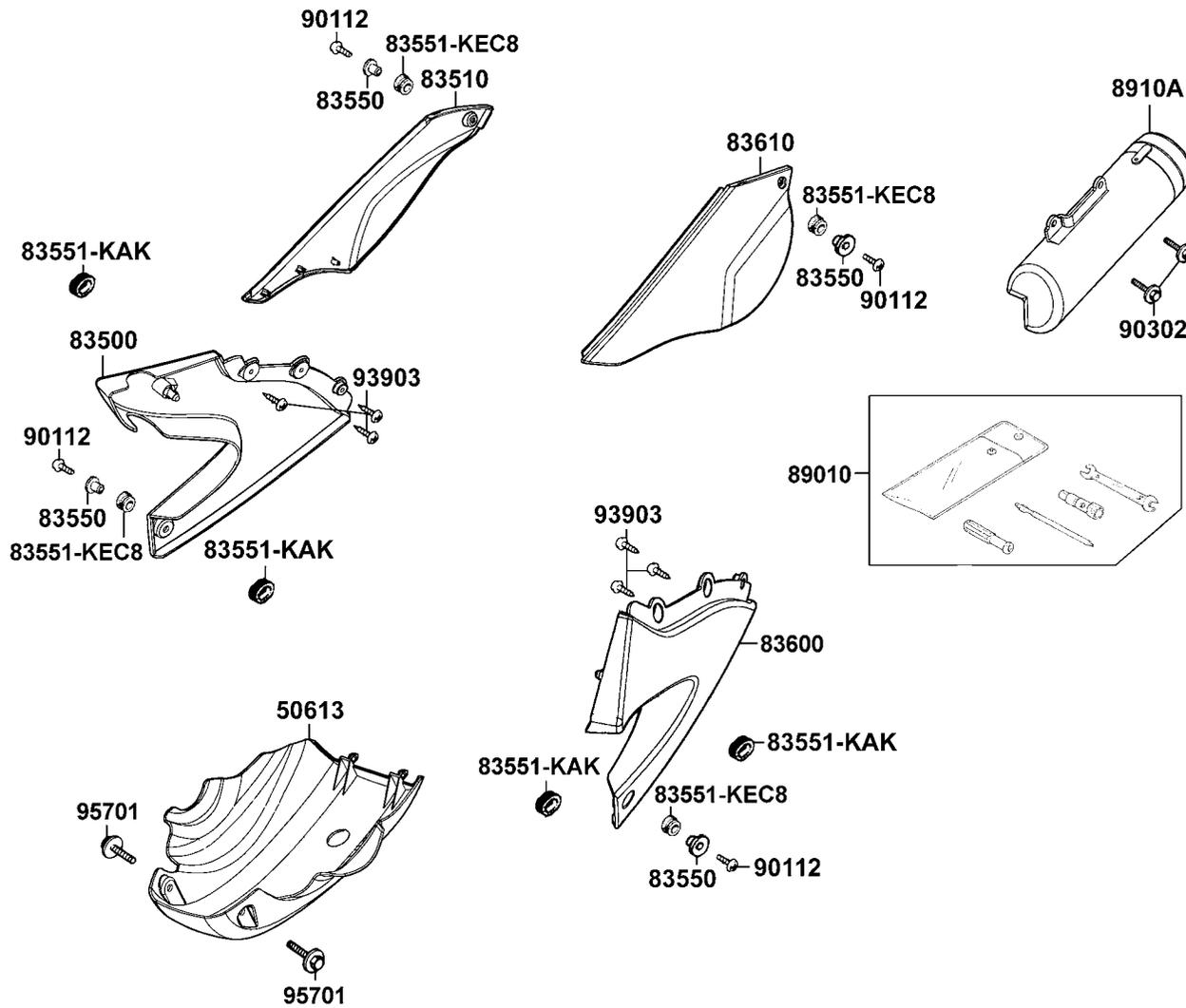

販賣記號	項目	零件號碼	版數	英文名稱	中文名稱	需要用量	參考價
Sales mark	Ref no	Part no	Ver	Description	Chinese	Regd no	Ref Price
**		50613-KEC8-900	0	COVER UNDER	下罩	1	
**		83500-KEC8-900	0	COVER R BODY A	右邊蓋 A	1	
**		83510-LLE2-305	0	COVER B SET R BODY	右邊蓋 B	1	
		83550-KEC8-9000	0	COLLAR	套筒	4	
		83551-KAK-9000	0	GROMMET AIR CLEANER CASE	橡皮	4	
		83551-KEC8-9000	0	GROMMET COVER	索環	4	
**		83600-KEC8-900	0	COVER L BODY A	左邊蓋 A	1	
**		83610-LLE2-305	0	COVER L B SET L BODY	左邊蓋 B	1	
		89010-KN7-C000	1	TOOL SET	工具包	1	
		8910A-KEC8-9000	0	TOOL BOX ASSY	工具盒	1	
		90112-KEC8-9000	0	SCREW SPECIAL 6*20	特殊螺絲 6*20	4	
		90302-GY6-9010	0	BOLT-WASH 5*12	螺絲 5*12	2	
		93903-34380	0	SCREW TAPPING 4*12	螺釘 4*12	6	
		95701-06016-08	0	BOLT FLANGE 6*16	螺絲 6*16	2	



販賣記號	項目	零件號碼	版數	英文名稱	中文名稱	需要用量	參考價
Sales mark	Ref no	Part no	Ver	Description	Chinese	Regd no	Ref Price
		11108-KEC8-9000	0	TUBE B	通氣管 B	1	
		15772-292-0100	0	CLIP BREATHER TUBE	管夾	2	
		17211-KEC8-9000	0	ELEMENT COMP AIR/C	空氣濾清器	1	
		17219-KEC8-9000	0	DUCT AIR/C	空氣導入管	1	
		17226-KEC8-9000	0	SEAL AIR/C CASE	空氣濾清箱蓋塵封	1	
		17228-KEC8-9000	0	COVER AIR/C CASE	空氣濾清箱蓋	1	
		1722B-KEC8-E00	0	CASE ASSY AIR/C	空氣濾清器箱組	1	
		17236-KBF-9100	1	PLATE	銷	1	
		17236-KEC8-9000	0	STAY B BATTERY	電瓶固定座 B	1	
		17254-KCA-P000	0	PLUG AIR/C CONN TUBE	空氣濾清器連接管塞	1	
		17265-KG7-0010	0	JOINT BLOW BY	空氣濾清箱接頭	1	
		17266-KG7-0010	0	PACKING ACV JOINT	防水封	1	
		17360-GE1-9000	2	CATCH TANK ASSY	曲軸箱廢氣回收器	1	
		5017A-KEC8-9000	0	STAY A ASSY BATTERY	電瓶固定座 A	1	
		90652-GY6-9010	0	BAND 49 AIR/C CONNECTING TUBE	連接管固定帶	1	
		93891-05012-07	0	SCREW WASHER 5*12	螺絲 5*12	2	
		93891-05016-08	0	SCREW WASHER 5*16	螺絲 5*16	4	
		93903-25380	0	SCREW TAPPING 5*16	螺釘 5*16	1	
		95002-02120	0	CLIP B12 TUBE	管夾	3	
		95005-KG7-9010	0	TUBE A	通氣管 A	1	

F 14

**F 14** Air Cleaner

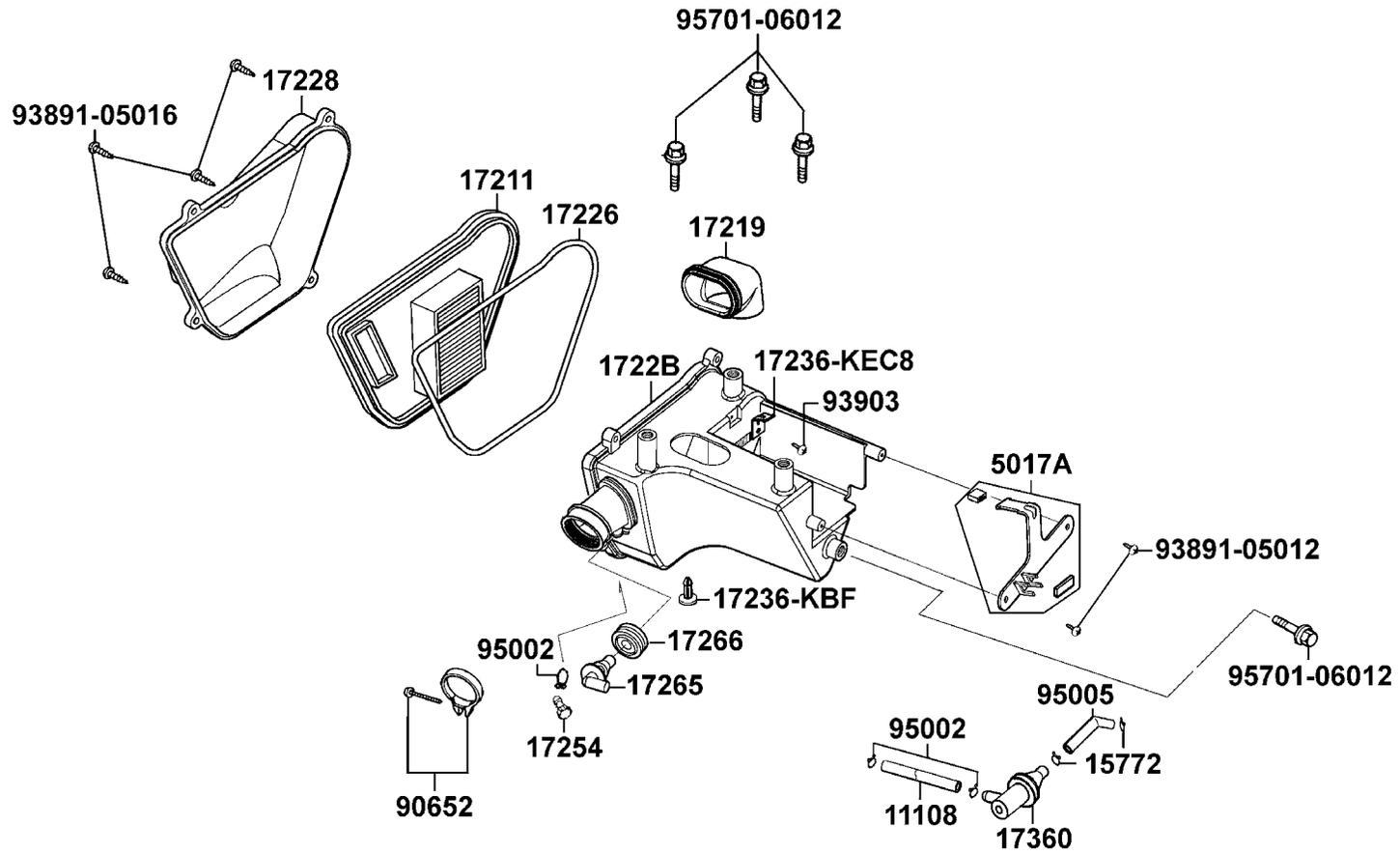



販賣記號	項目	零件號碼	版數	英文名稱	中文名稱	需要用量	參考價
Sales mark	Ref no	Part no	Ver	Description	Chinese	Regd no	Ref Price
		95701-06012-08	0	BOLT FLANGE 6*12	螺絲 6*12	4	

F 14

**F 15 Exhaust Muffler**

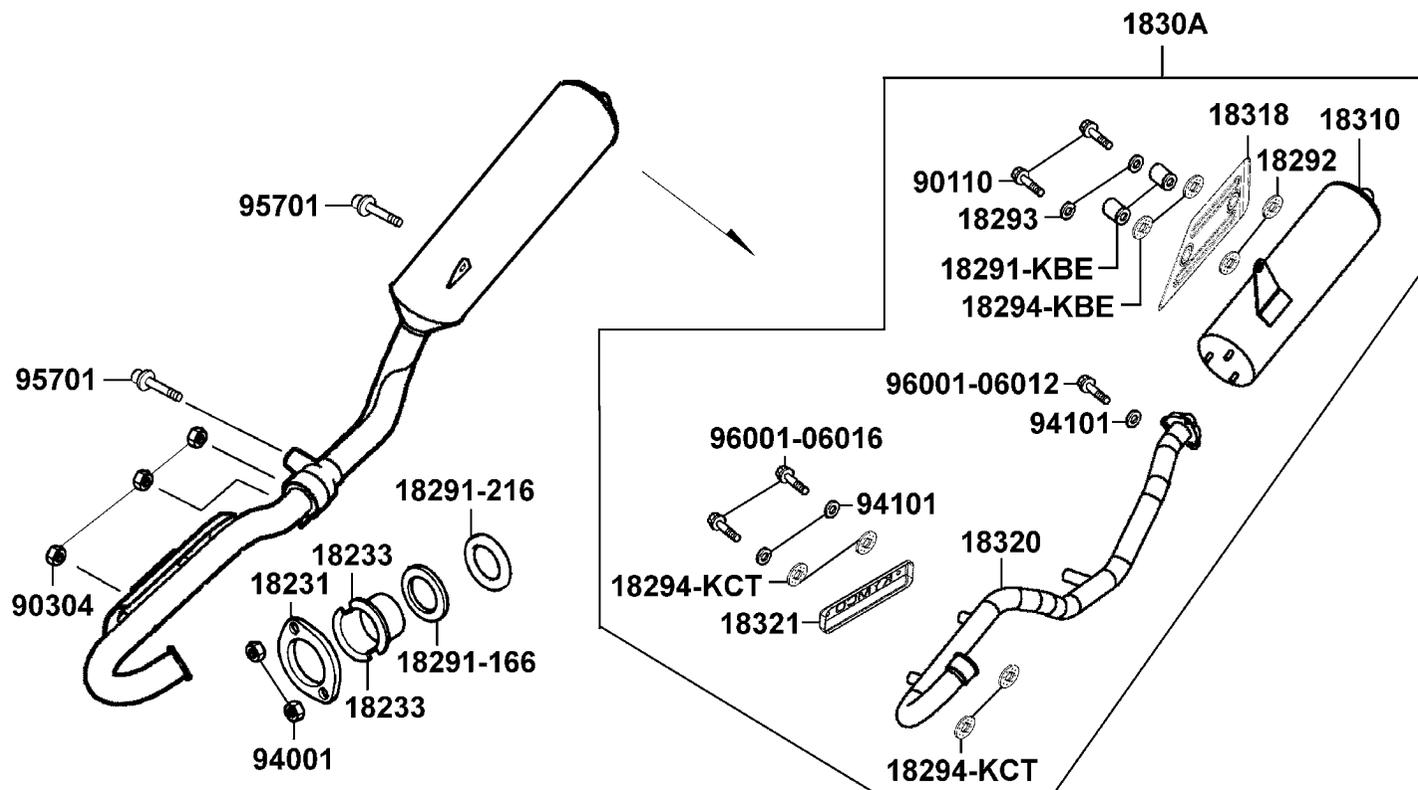

販賣記號	項目	零件號碼	版數	英文名稱	中文名稱	需要用量	參考價
Sales mark	Ref no	Part no	Ver	Description	Chinese	Regd no	Ref Price
		18231-365-6710	0	JOINT EXH PIPE	排氣管接頭	1	
		18233-383-9000	1	COLLAR EXHAUST PIPE JOINT	接頭套筒	2	
		18291-166-0040	0	GASKET EXHAUST PIPE	排氣管墊圈	1	
		18291-216-0010	1	GASKET EXHAUST PIPE	排氣管墊圈	1	
		18291-KBE-9000	0	COLLAR	襯套	2	
		18292-KBE-9000	0	PACKING PROTECTOR	墊片	2	
		18293-KBE-9000	0	RUBBER PKG PROTR	橡皮	2	
		18294-KBE-9000	0	PACKING PROTECTOR	墊片	2	
		18294-KCT-9000	0	PACKING PROTECTOR	墊片	4	
		1830A-KFB1-EZ0	1	MUFFLER ASSY EXHAUST	排氣管組	1	
		18310-KFB1-EZ0	0	MUFFLER COMP	排氣管	1	
		18318-KEC8-9000	0	PROTECTOR MUFF BODY	排氣管護蓋	1	
		18320-KFB1-EZ0	1	PIPE COMP EXHAUST	排氣管接管	1	
		18321-KEC8-9000	0	PROTECTOR EXHAUST PIPE	排氣接管護蓋	1	
		90110-KBE-9000	0	SCREW SPECIAL 6*22	螺絲 6*22	2	
		90304-HB3-7720-M1	0	NUT SPECIAL 6MM	特殊螺帽 6MM	3	
		94001-06080-0S	0	NUT HEX 6MM	螺帽 6MM	2	
		94101-06000	0	WASHER PLAIN 6MM	華司 6MM	3	
		95701-08012-08	0	BOLT FLANGE 8*12	螺絲 8*12	2	
		96001-06012-02	0	BOLT FLANGE SH 6*12	螺絲 6*12	1	

**F 15 Exhaust Muffler**

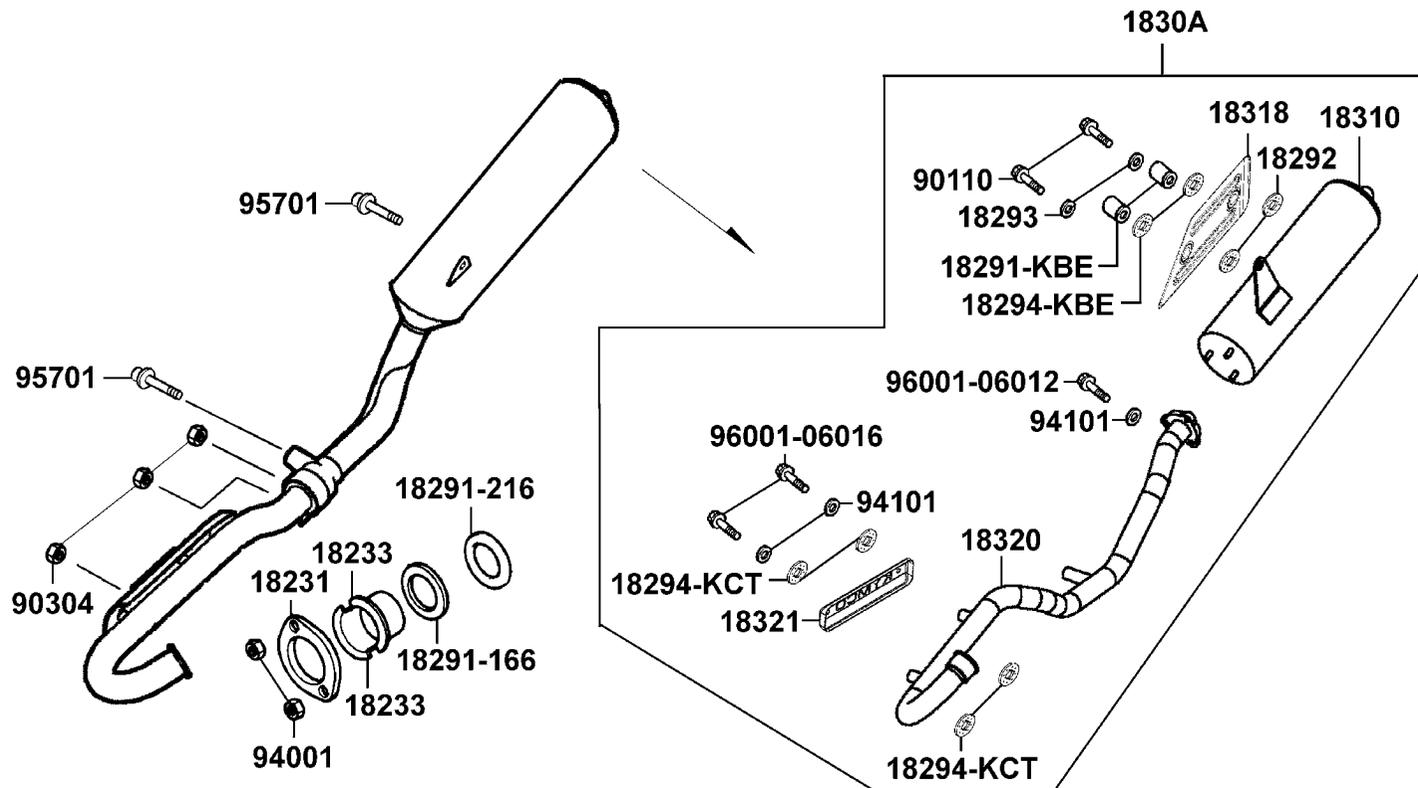

販賣記號	項目	零件號碼	版數	英文名稱	中文名稱	需要用量	參考價
Sales mark	Ref no	Part no	Ver	Description	Chinese	Regd no	Ref Price
		96001-06016-02	0	BOLT FLANGE SH 6*16	螺絲 6*16	2	

F 15

**F 16 Pedal**

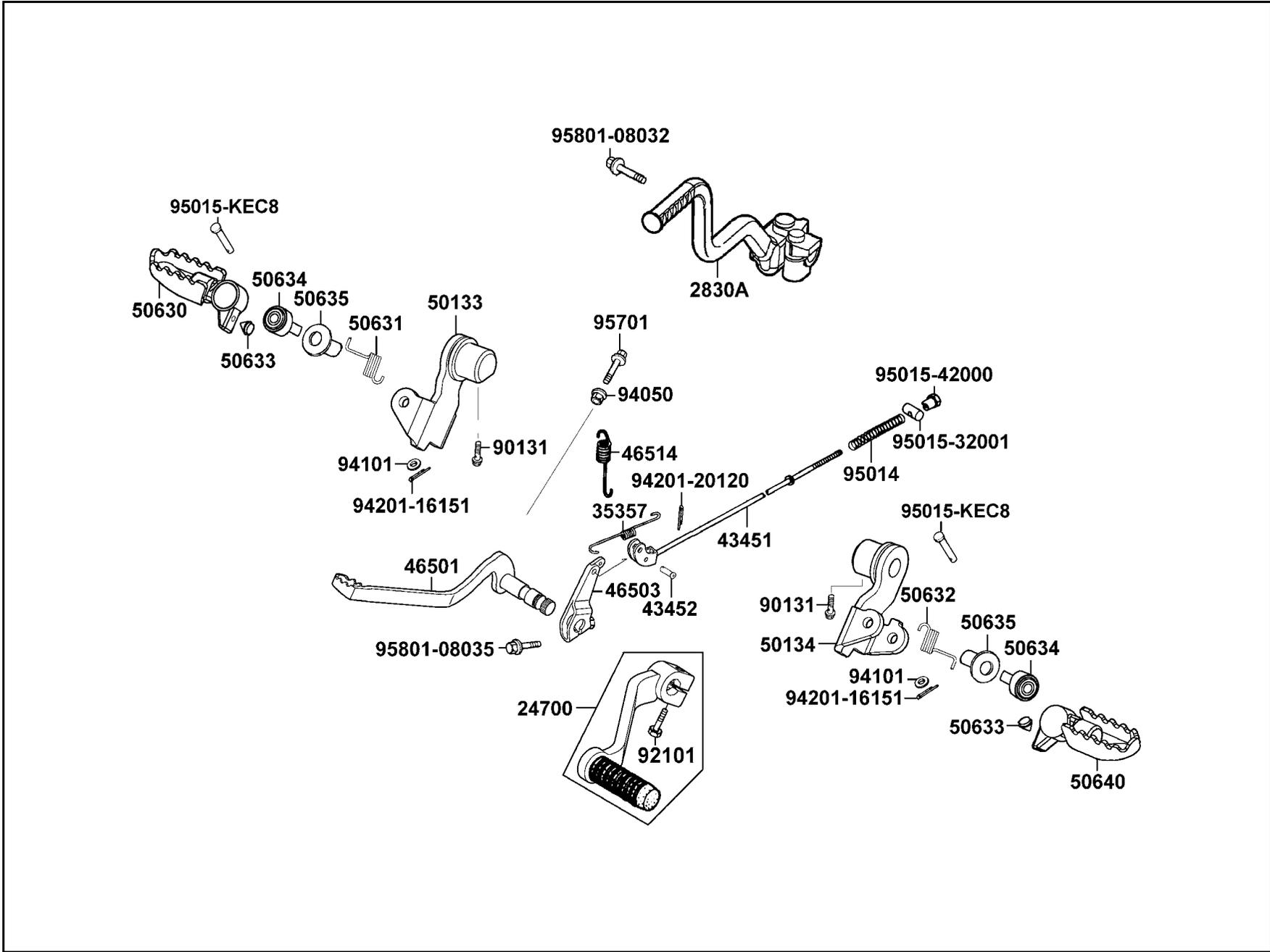

販賣記號	項目	零件號碼	版數	英文名稱	中文名稱	需要用量	參考價
Sales mark	Ref no	Part no	Ver	Description	Chinese	Regd no	Ref Price
		24700-KEC8-9000	0	PEDAL ASSY CHNG	變速踏板	1	
		2830A-KEC8-9000	0	ARM ASSY KICK	起動踏桿組	1	
		35357-KEC8-9000	0	SPRING STOP SWITCH	後置開關彈簧	1	
		43451-KEC8-9000	1	ROD RR BRAKE	後煞車連桿	1	
		43452-KEC8-9000	0	BRAKE ROD JOINT PIN	後煞車連桿插銷	1	
		46501-KEC8-900	1	PEDAL COMP RR BRAKE	後煞車踏桿	1	
		46503-KEC8-9000	0	ARM RR BRAKE PEDAL	後煞車踏桿臂	1	
		46514-KEC8-9000	0	SPRING BRAKE RETURN	後煞車桿回位彈簧	1	
		50133-KEC8-9000	0	BRKT R FR STEP	右前腳踏桿	1	
		50134-KEC8-9000	0	BRKT L FR STEP	左前腳踏桿	1	
		50630-KEC8-9000	0	STEP COMP R MAIN	右踏板	1	
		50631-KEC8-9000	0	SPRING R MAIN STEP	右前踏板回位彈簧	1	
		50632-KEC8-9000	0	SPRING L MAIN STEP	左前踏板回位彈簧	1	
		50633-KEC8-9000	0	STOPPER MAIN STEP	前踏板止位銷	2	
		50634-KEC8-9000	0	BUSH COMP MAIN STEP	前踏板襯套	2	
		50635-KEC8-9000	0	COLLAR MAIN STEP	前踏板套筒	2	
		50640-KEC8-9000	0	STEP COMP L MAIN	左踏板	1	
		90131-KBE-9000	0	BOLT FLANGE 8*24	螺絲 8*24	2	
		92101-06020-0H	0	BOLT HEX 6*20	螺絲 6*20	1	
		94050-06080	0	NUT FLANGE 6MM	螺帽 6MM	1	

F 16

**F 16** Pedal

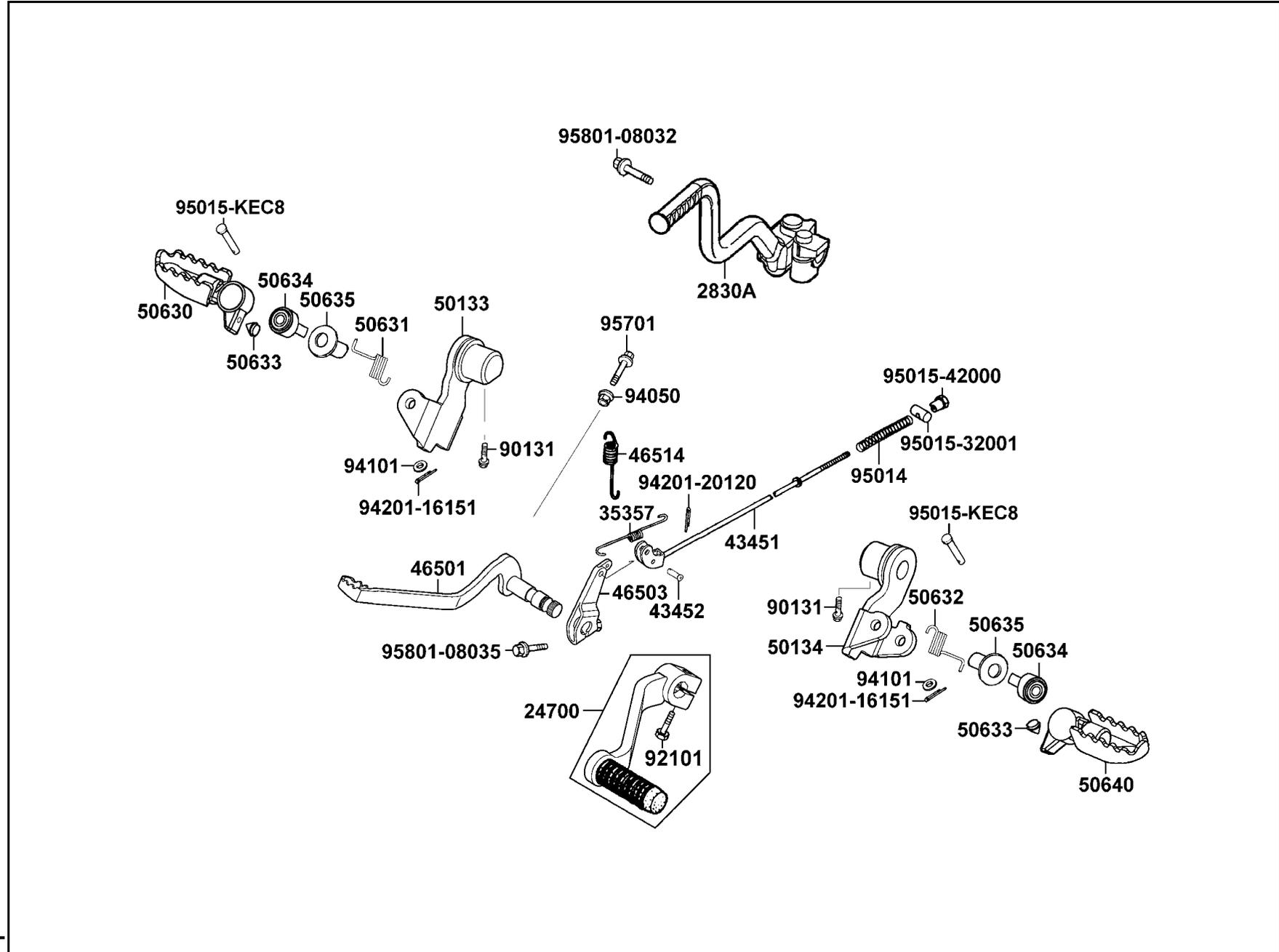



販賣記號	項目	零件號碼	版數	英文名稱	中文名稱	需要用量	參考價
Sales mark	Ref no	Part no	Ver	Description	Chinese	Regd no	Ref Price
		94101-08800	0	WASHER PLAIN 8MM	華司 8MM	2	
		94201-16151	0	PIN SPLIT 1.6*15	插銷 1.6*15	2	
		94201-20120	0	PIN SPLIT 2*12	插銷 2*12	1	
		95014-73100	0	SPG A BRAKE ROD	後煞車連桿彈簧	1	
		95015-32001	0	JOINT B BRAKE ARM	調節接頭	1	
		95015-42000	0	NUT B ADJUST	調節螺帽	1	
		95015-KEC8-9000	0	PIN P STEP	插銷	2	
		95701-06020-08	0	BOLT FLANGE 6*20	螺絲 6*20	1	
		95801-08032-07	0	BOLT FLANGE 8*32	螺絲 8*32	1	
		95801-08035-08	0	BOLT FLANGE 8*35	螺絲 8*35	1	

F 16



販賣記號	項目	零件號碼	版數	英文名稱	中文名稱	需要用量	參考價
Sales mark	Ref no	Part no	Ver	Description	Chinese	Regd no	Ref Price
		35370-KEC8-E000	1	SW UNIT SIDE STAND	側支架開關	1	
		40510-KEC8-9000	0	CASE UPPER DRIVE CHAIN	外鏈蓋	1	
		40520-KEC8-9000	0	COVER SIDE DRIVE CHAIN	外鏈條邊蓋	1	
		40530-KEC8-9000-M1	0	CHAIN DRIVE	外鏈條	1	
		40543-KEC8-9000	0	ADJUSTER CHAIN L/R	鏈條調整器	2	
		43431-KEC8-9000	0	STPR ARM RR BRAKE	後煞車制動臂	1	
		43434-286-0010	0	RUBBER STOPPER ARM CUSHION	阻止臂橡皮	1	
		50530-KEC8-E000	0	SIDE STAND COMP	側支架	1	
		50535-KEC8-E000	0	SPG COMP SIDE STAND	側支架彈簧	1	
		50548-324-7610-01	0	RUBBER STAND	側支架橡皮	1	
		50549-356-7000	0	COLLAR STAND RUB SET	套筒	1	
		52108-KE5-0040	0	BUSH REAR FORK	襯套	2	
		52108-KW6-9010	0	COLLAR CHAIN SLIDER	襯套	2	
		52110-KEC8-9000	0	ARM COMP SWING	後叉	1	
		52141-KEC8-9000	0	COLLAR RR FORK	後叉套筒	1	
		52144-GE2-0060	0	CAP RR FORK DUST SEAL	後叉防塵蓋	2	
		52171-KEC8-9000	0	SLIDER CHAIN	外鏈條導件	1	
		52172-KEC8-9000	1	SLIDER UNDER	鏈條固定座	1	
		52173-KEC8-9000	0	NUT SLIDER UNDER	鏈條調整器螺帽	1	
		52200-KEC8-9000	0	ARM ASSY RR CUSHION	後緩衝桿臂	1	

F 17

**F 17 Rear Fork●Chain Case**

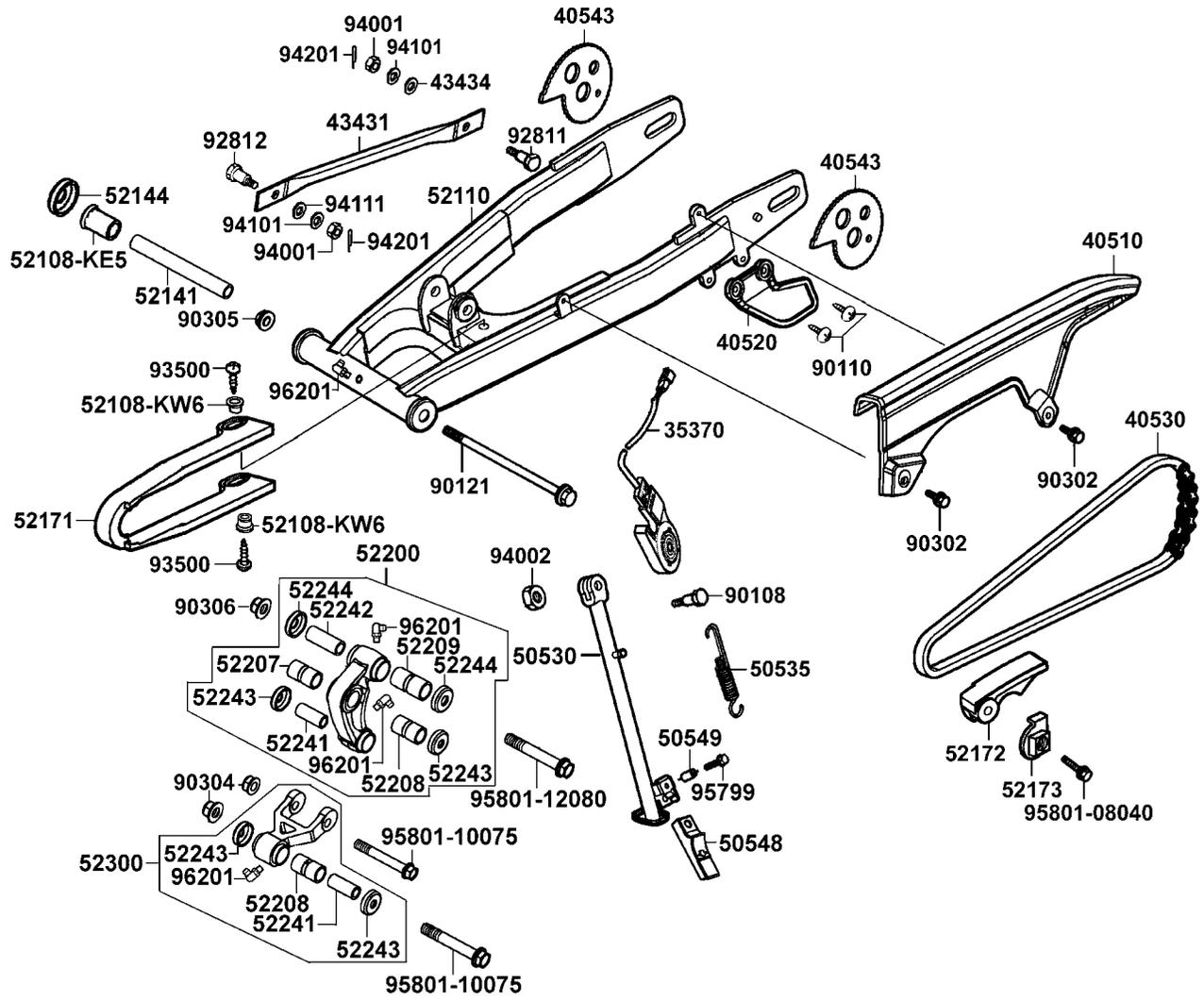

販賣記號	項目	零件號碼	版數	英文名稱	中文名稱	需要用量	參考價
Sales mark	Ref no	Part no	Ver	Description	Chinese	Regd no	Ref Price
		52207-KEC8-9000	0	BUSH CUSH ARM C	襯套 C	1	
		52208-KEC8-9000	0	BUSH RR CUSHION A	襯套 A	2	
		52209-KEC8-9000	0	BUSH RR CUSHION B	襯套 B	1	
		52241-KEC8-9000	0	COLLAR RR LINK A	套筒 A	2	
		52242-KEC8-9000	0	COLLAR RR LINK B	套筒 B	1	
		52243-KEC8-9000	0	DUST SEAL RR CUSH ARM A	防塵蓋 A	4	
		52244-KEC8-9000	0	DUST SEAL RR CUSH ARM B	防塵蓋 B	2	
		52300-KEC8-9000	0	LIN ASSY RR CUSHION	後緩衝桿驅軸	1	
		90108-KEC8-E000	0	SCREW SIDE STAND PIVOT	側支架螺絲	1	
		90110-KEB7-9000	0	SCREW SPECIAL 6*14	特殊螺絲 6*14	2	
		90121-KEC8-900	2	BOLT RR FORK	後叉樞軸螺絲	1	
		90302-GY6-9010	0	BOLT-WASH 5*12	螺絲 5*12	2	
		90304-GE8-0040	0	NUT U 10MM	螺帽 10MM	2	
		90305-GE8-9010	0	NUT U 14MM	螺帽 14MM	1	
		90306-KF0-901	0	NUT FLANGE 12MM	螺帽 12MM	1	
		92811-KAK-9000	2	BOLT B STPR ARM	螺絲	1	
		92812-KCD-9000	1	RR BRAKE STOPPER ARM BOLT	螺絲	1	
		93500-06014-0B	0	SCREW PAN 6*14	螺絲 6*14	2	
		94001-08080-0S	0	NUT HEX 8MM	螺帽 8MM	2	
		94002-10080-0S	0	NUT HEX 10MM	螺帽 10MM	1	

**F 17 Rear Fork●Step●Chain Case**

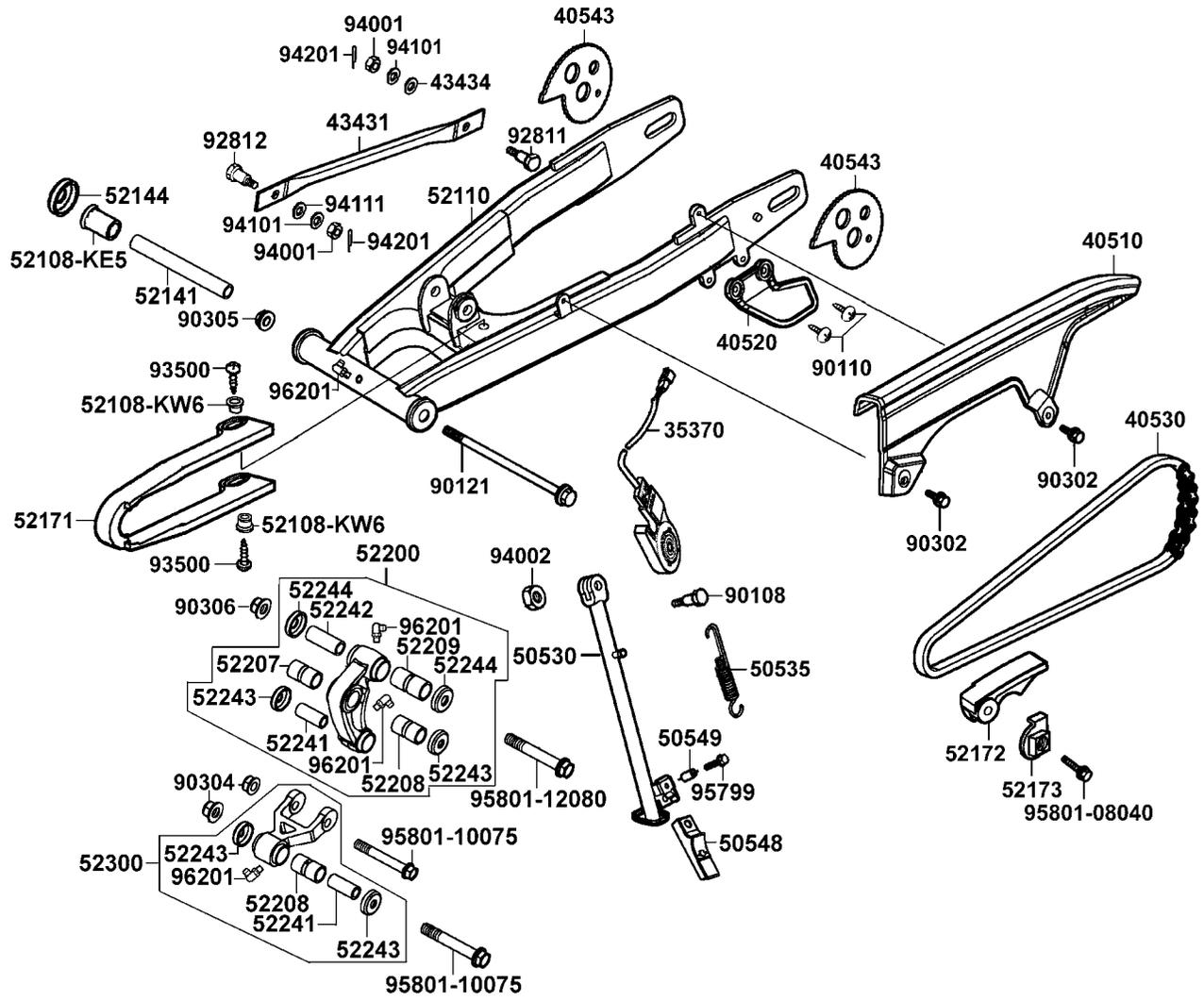

販賣記號	項目	零件號碼	版數	英文名稱	中文名稱	需要用量	參考價
Sales mark	Ref no	Part no	Ver	Description	Chinese	Regd no	Ref Price
		94101-08800	0	WASHER PLAIN 8MM	華司 8MM	2	
		94111-10800	0	WASHER SPG 10MM	彈簧華司 10MM	1	
		94201-20151	0	PIN SPLIT 2*15	開口銷 2*15	2	
		95799-06025-07	0	BOLT FLANGE 6*25	螺絲 6*25	1	
		95801-08040-08	0	BOLT FLANGE 8*40	螺絲 8*40	1	
		95801-10075-08	0	BOLT FLANGE 10*75	螺絲 10*75	2	
		95801-12080-08	0	BOLT FLANGE 12*80	螺絲 12*80	1	
		96201-KEC8-9000	0	NIPPLE GREASE	潤滑油嘴	4	

F 17

**F 18** Rear Cushion

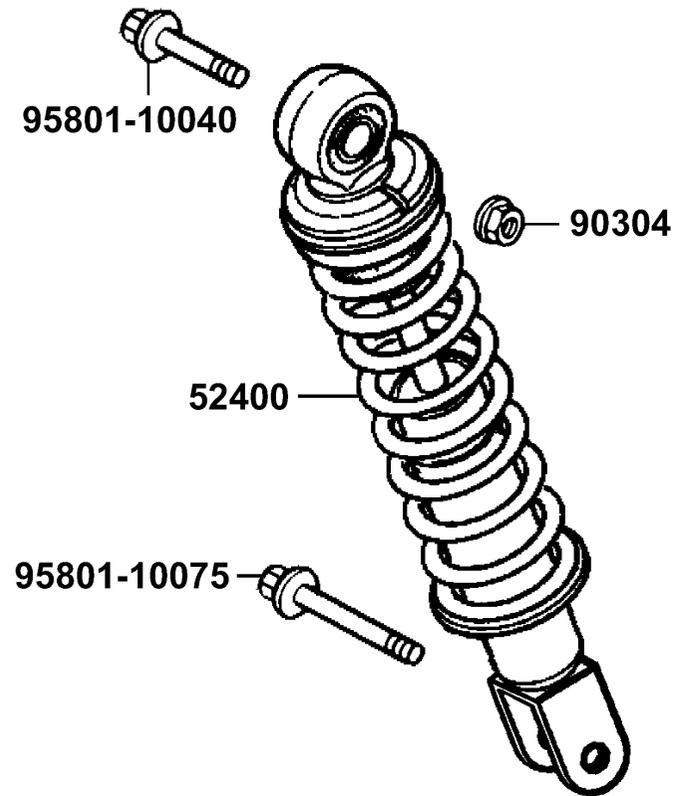



販賣記號	項目	零件號碼	版數	英文名稱	中文名稱	需要用量	參考價
Sales mark	Ref no	Part no	Ver	Description	Chinese	Regd no	Ref Price
**		52400-KEC8-900	0	CUSHION ASSY REAR	後避震器組	1	
		90304-GE8-0040	0	NUT U 10MM	螺帽 10MM	1	
		95801-10040-08	0	BOLT FLANGE 10*40	螺絲 10*40	1	
		95801-10075-08	0	BOLT FLANGE 10*75	螺絲 10*75	1	

F 18

**F 19** Rear Fender

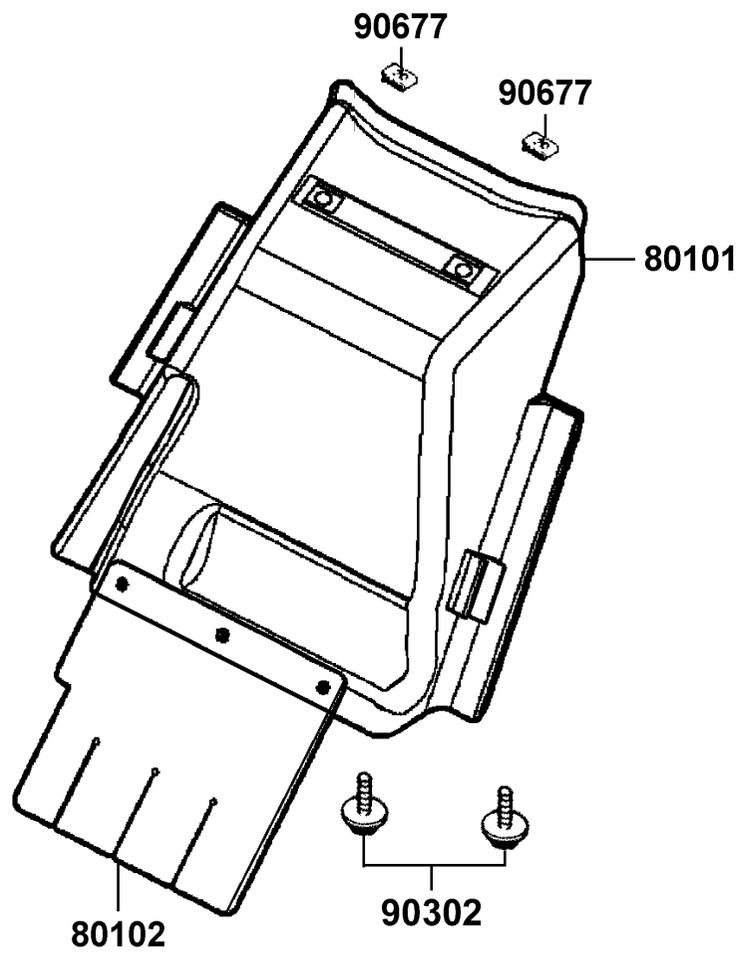

販賣記號	項目	零件號碼	版數	英文名稱	中文名稱	需要用量	參考價
Sales mark	Ref no	Part no	Ver	Description	Chinese	Regd no	Ref Price
		80101-KEC8-8000	0	FENDER A REAR	後土除 A	1	
		80102-KEC8-9000	0	PLATE SPLASH GUARD	防濺板	1	
		90302-GY6-9400	0	BOLT-WASH 5*16	螺絲 5*16	2	
		90677-GR1-0030	1	NUT CLIP 5MM	螺帽夾 5MM	2	

F 19

**F 20 Winker**

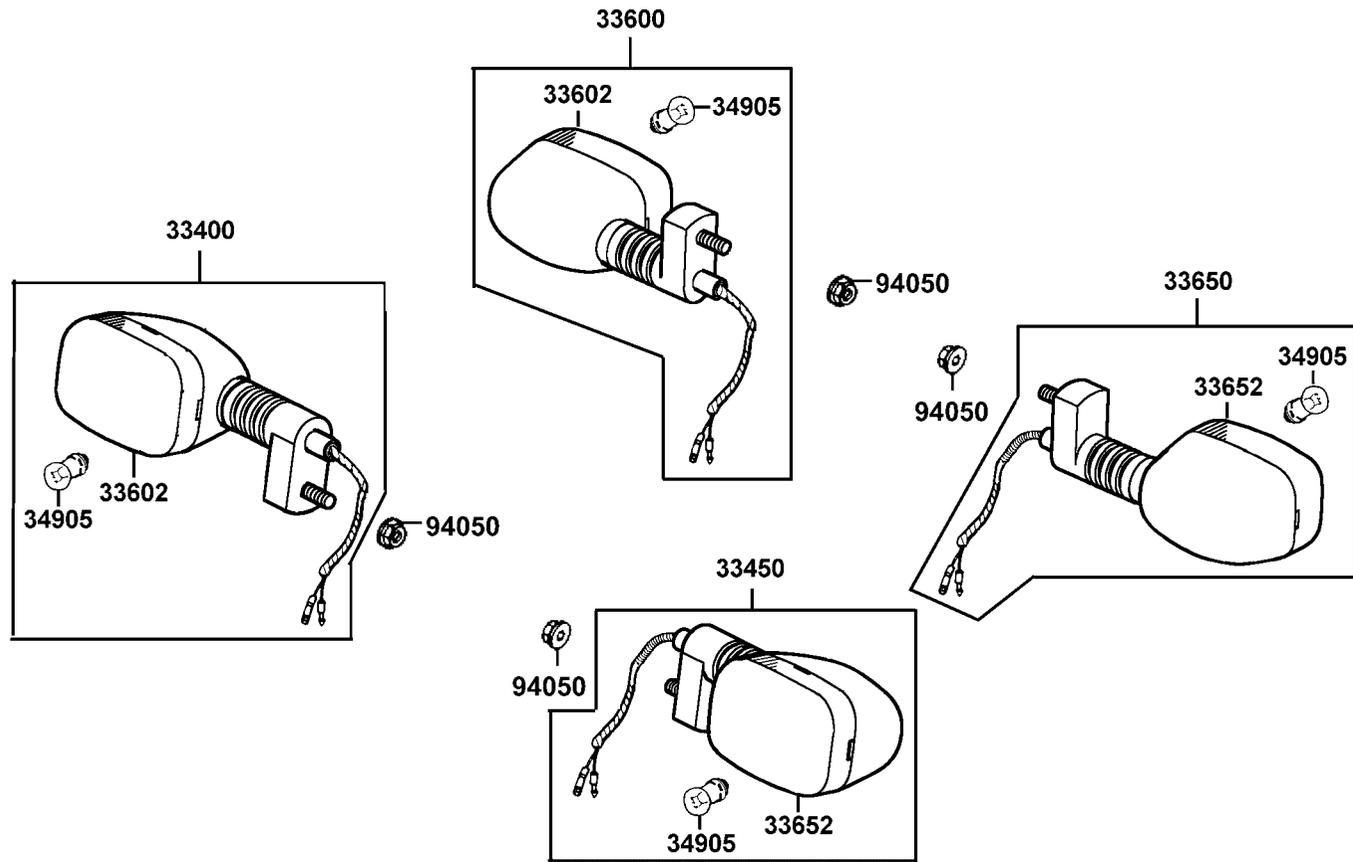

販賣記號	項目	零件號碼	版數	英文名稱	中文名稱	需要用量	參考價
Sales mark	Ref no	Part no	Ver	Description	Chinese	Regd no	Ref Price
		33400-KEC8-9000	0	WINKER ASSY R FR	右前方向燈組	1	
		33450-KEC8-9000	0	WINKER ASSY L FR	左前方向燈組	1	
		33600-KEC8-9000	0	WINKER ASSY R RR	右後方向燈組	1	
		33602-KCP-9000	1	LENS R RR WINKER	右方向燈殼	2	
		33650-KEC8-9000	0	WINKER ASSY L RR	左後方向燈組	1	
		33652-KCP-9000	1	LENS L RR WINKER	左方向燈殼	2	
		34905-KCP-9000	0	BULB WINKER	方向燈燈泡	4	
		94050-10080	0	NUT FLANGE 10MM	螺帽 10MM	4	

**F 21 Tail Light●Rear Carrier**

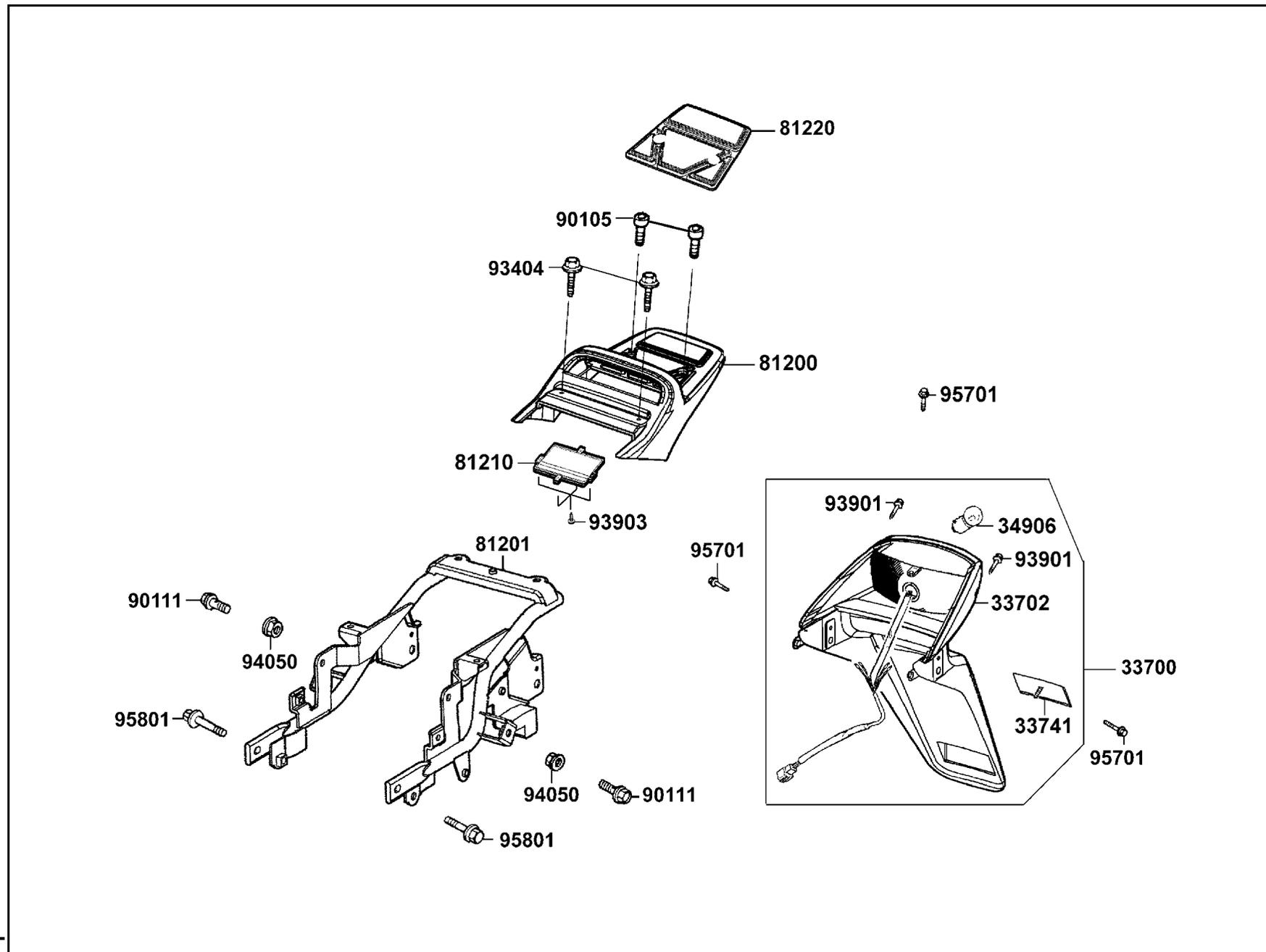

販賣記號	項目	零件號碼	版數	英文名稱	中文名稱	需要用量	參考價
Sales mark	Ref no	Part no	Ver	Description	Chinese	Regd no	Ref Price
		33700-KEC8-9000	2	LIGHT ASSY TAIL	後燈組	1	
		33702-KEC8-9000	0	LENS COMP TAIL LIGHT	後燈殼	1	
		33741-KEC8-9000	0	REFLEX REFLECTOR	後燈反射片	1	
		34906-KCP-9000	0	BULB TAIL & STOP	後燈燈泡	1	
**		81200-KEC8-900	0	CARRIER REAR	後架	1	
		81201-KEC8-9000	0	STAY RR CARRIER	後架支柱	1	
**		81210-KEC8-900	0	LID REAR CARRIER	後架小蓋	1	
		81220-KEC8-9000	0	MAT CARRIER	後架墊片	1	
		90105-KEC8-9000	0	BOLT WASH 8MM	螺絲 8MM	2	
		90111-147-0000	0	BOLT FLANGE 6*17	螺絲 6*17	2	
		93404-06020-07	0	BOLT WASHER 6*20	螺絲 6*20	2	
		93901-34420	0	SCREW TAPPING 4*16	螺釘 4*16	2	
		93903-34380	0	SCREW TAPPING 4*12	螺釘 4*12	4	
		94050-06080	0	NUT FLANGE 6MM	螺帽 6MM	2	
		95701-06012-08	0	BOLT FLANGE 6*12	螺絲 6*12	3	
		95801-08020-08	0	BOLT FLANGE 8*20	螺絲 8*20	2	

**F 22 Wire Harness**

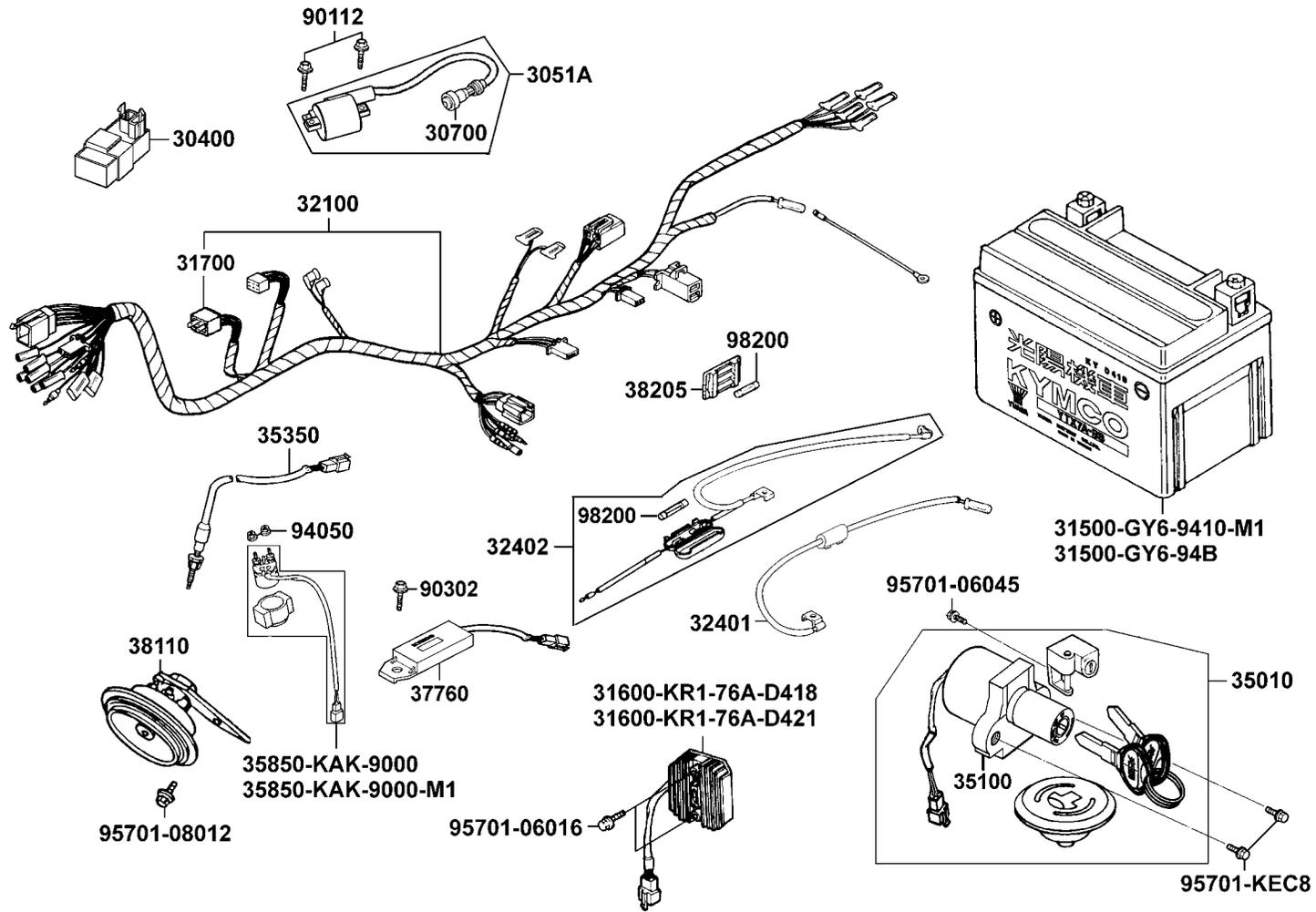



販賣記號	項目	零件號碼	版數	英文名稱	中文名稱	需要用量	參考價
Sales mark	Ref no	Part no	Ver	Description	Chinese	Regd no	Ref Price
		30400-KEC8-E000	0	UNIT ASSY CDI	CDI組	1	
		3051A-KEC8-9000	2	COIL ASSY IGN	點火線圈	1	
		30700-KN7-6710	2	CAP NOISE SUPPERSSOR	火星塞蓋	1	
		31500-GY6-9410-M1	2	BATTERY YTX7A-BS	電瓶/YTX7A-BS	1	
		31500-GY6-94B	5	BATTERY GTX7A-BS	電瓶/GTX7A-BS	1	
		31600-KR1-76A-D418	0	REG REC COMP (DC)	整流器	1	
		31600-KR1-76A-D421	0	REG REC COMP (DC)	整流器	1	
		31700-KEC8-E000	0	RECTIFIER COMP DIODE	二極體整流器	1	
		32100-LLE2-E00	2	HARNESS WIRE	主配線	1	
		32401-KEC8-9000	0	CABLE EARTH	接地導線	1	
		32402-KEC8-9000	1	CABLE RELAY & BATTERY	電瓶繼電器配線	1	
		35010-KEC8-E000	0	KEY SET	開關組	1	
		35100-KEC8-3050	0	SW SET COMB & LOCK	主開關鎖組	1	
		35350-KE2-941	0	SW ASSY REAR STOP	後煞車燈開關組	1	
		35850-KAK-9000	1	SET START MAG	起動繼電器	1	
		35850-KAK-9000-M1	1	SET START MAG	起動繼電器	1	
		37760-KGBG-E100	0	UNIT HEATER CONTROL	加熱控制器	1	
		38110-KBE-9000-M1	1	HORN COMP	喇叭	1	
		38205-115-0010	0	CASE FUSE	保險絲盒	1	
		90112-KDR-9000	0	BOLT FLANGE 5*22	螺絲 5*22	2	

F 22

**F 22 Wire Harness**

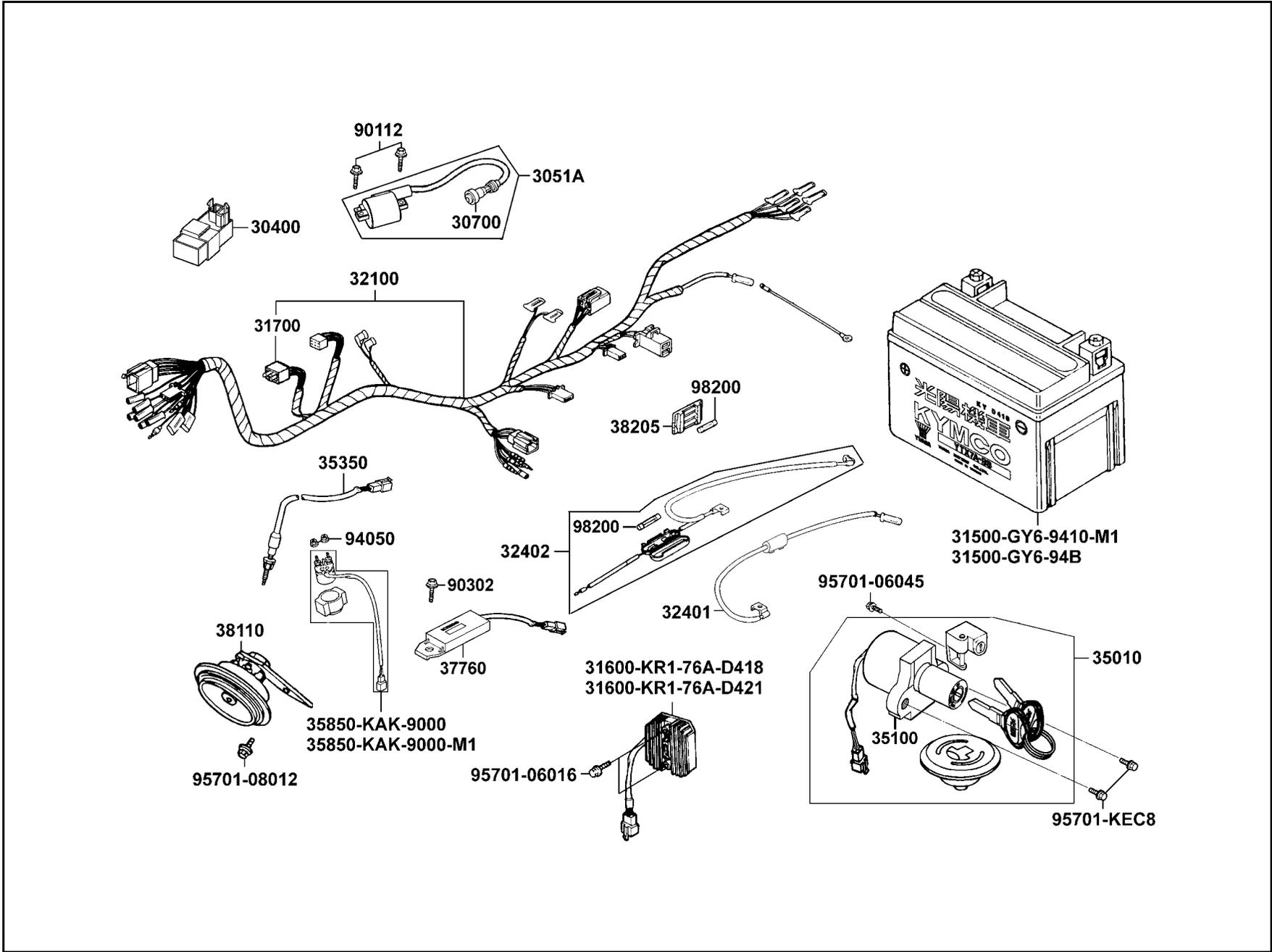

販賣記號	項目	零件號碼	版數	英文名稱	中文名稱	需要用量	參考價
Sales mark	Ref no	Part no	Ver	Description	Chinese	Regd no	Ref Price
		90302-GY6-9010	0	BOLT-WASH 5*12	螺絲 5*12	1	
		94050-06080	0	NUT FLANGE 6MM	螺帽 6MM	2	
		95701-06016-08	0	BOLT FLANGE 6*16	螺絲 6*16	2	
		95701-06045-08	0	BOLT FLANGE 6*45	螺絲 6*45	1	
		95701-08012-08	0	BOLT FLANGE 8*12	螺絲 8*12	1	
		95701-KEC8-E000	0	BOLT TORQUE 8*19	螺絲 8*19	2	
		98200-11500	0	FUSE A15	保險絲 A15	2	

**F 23** Frame Body

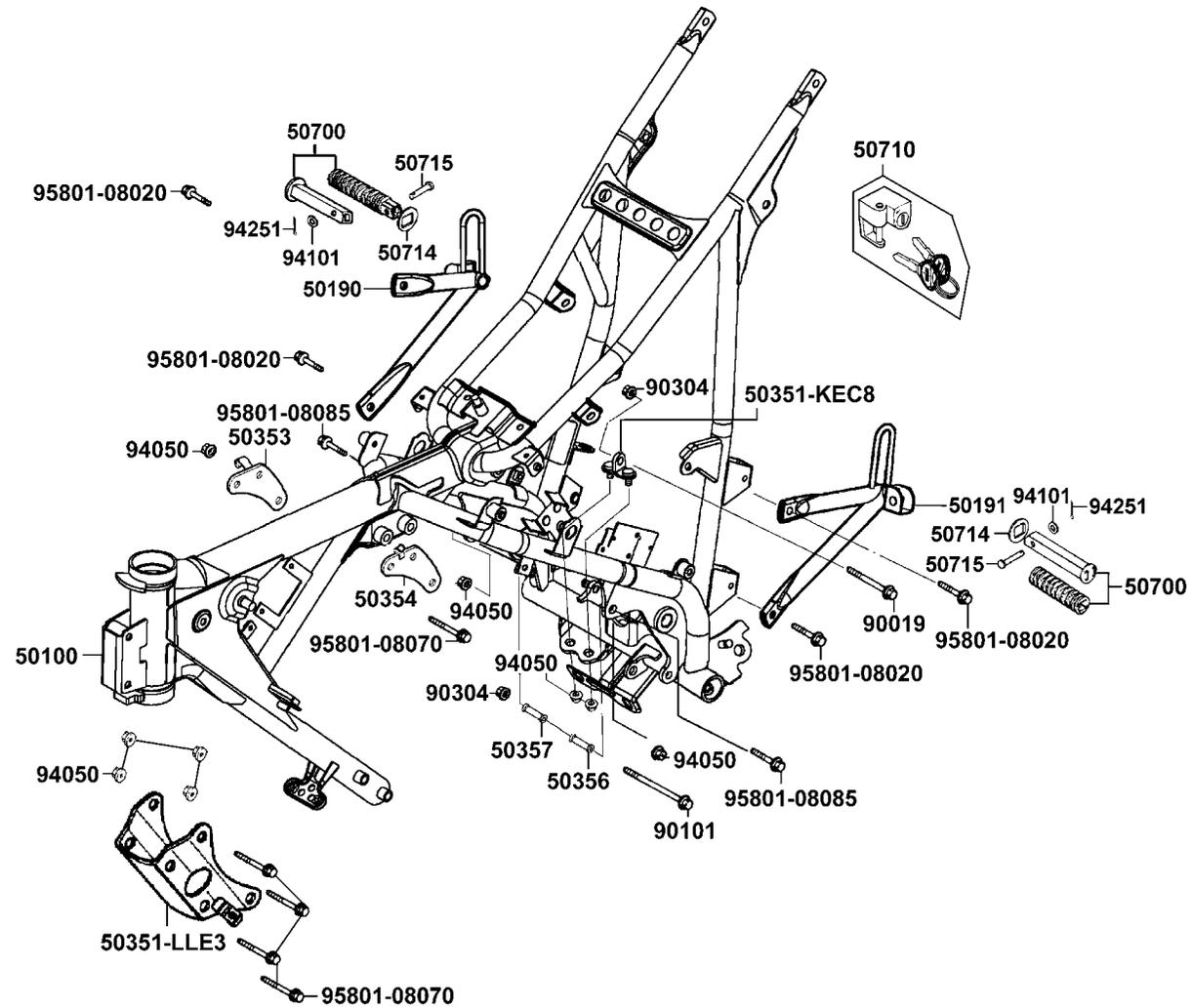

販賣記號	項目	零件號碼	版數	英文名稱	中文名稱	需要用量	參考價
Sales mark	Ref no	Part no	Ver	Description	Chinese	Regd no	Ref Price
		50100-LLE3-E00	4	BODY COMP FRAME	車體	1	
		50190-KEC8-9000	1	STEP COMP R PILLION	右踏板連桿	1	
		50191-KEC8-9000	0	STEP COMP L PILLION	左踏板連桿	1	
		50351-KEC8-9000	0	SLIDER HANGER BOTTOM	引擎吊架固定座	1	
		50351-LLE3-E00	1	PLATE FR ENG HANGER	引擎前端吊架	1	
		50353-KEC8-9000	2	PLATE R ENG UP HANGER	引擎右上端吊板	1	
		50354-KEC8-9000	0	PLATE L ENG UP HANGER	引擎左上端吊板	1	
		50356-KEC8-9000	1	COLLAR ENG L	左邊引擎套筒	1	
		50357-KEC8-9000	1	COLLAR ENG R	右邊引擎套筒	1	
		50700-KEC8-3050	0	BAR PILLION ASSY STEP	踏板	2	
		50710-086-3150-M1	0	HOLDER HELMET SET	安全帽固定鎖	1	
		50714-KEC8-9000	0	WASHER	腳踏板華司	2	
		50715-KEC8-9000	0	PIN PILLION STEP	插銷	2	
		90019-399-0110	1	BOLT FLANGE 10*113	螺絲 10*113	1	
		90101-KEC8-9000	1	BOLT FLANGE 10*250	螺絲 10*250	1	
		90304-GE8-0040	0	NUT U 10MM	螺帽 10MM	2	
		94050-KBE2-9000	0	NUT FLANGE 8MM	螺帽 8MM	9	
		94101-06800	0	WASHER PLAIN 6MM	華司 6MM	2	
		94251-06400	0	PIN LOCK 6MM	插銷	2	
		95801-08020-08	0	BOLT FLANGE 8*20	螺絲 8*20	4	

**F 23** Frame Body

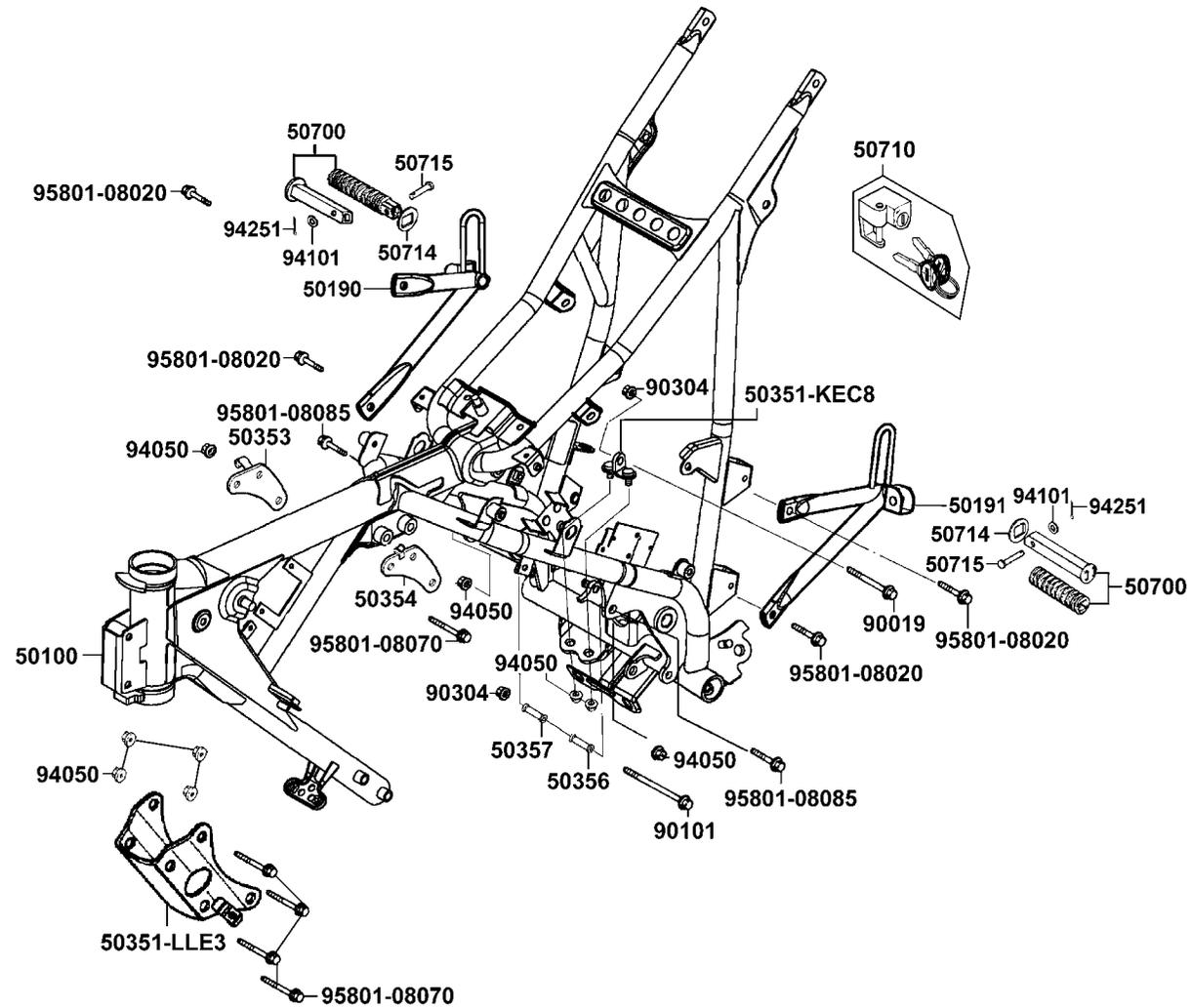

販賣記號	項目	零件號碼	版數	英文名稱	中文名稱	需要用量	參考價
Sales mark	Ref no	Part no	Ver	Description	Chinese	Regd no	Ref Price
		95801-08070-08	0	BOLT FLANGE 8*70	螺絲 8*70	5	
		95801-08085-08	0	BOLT FLANGE 8*85	螺絲 8*85	2	

F 23

**F 24** Air Cleaner AICV Set

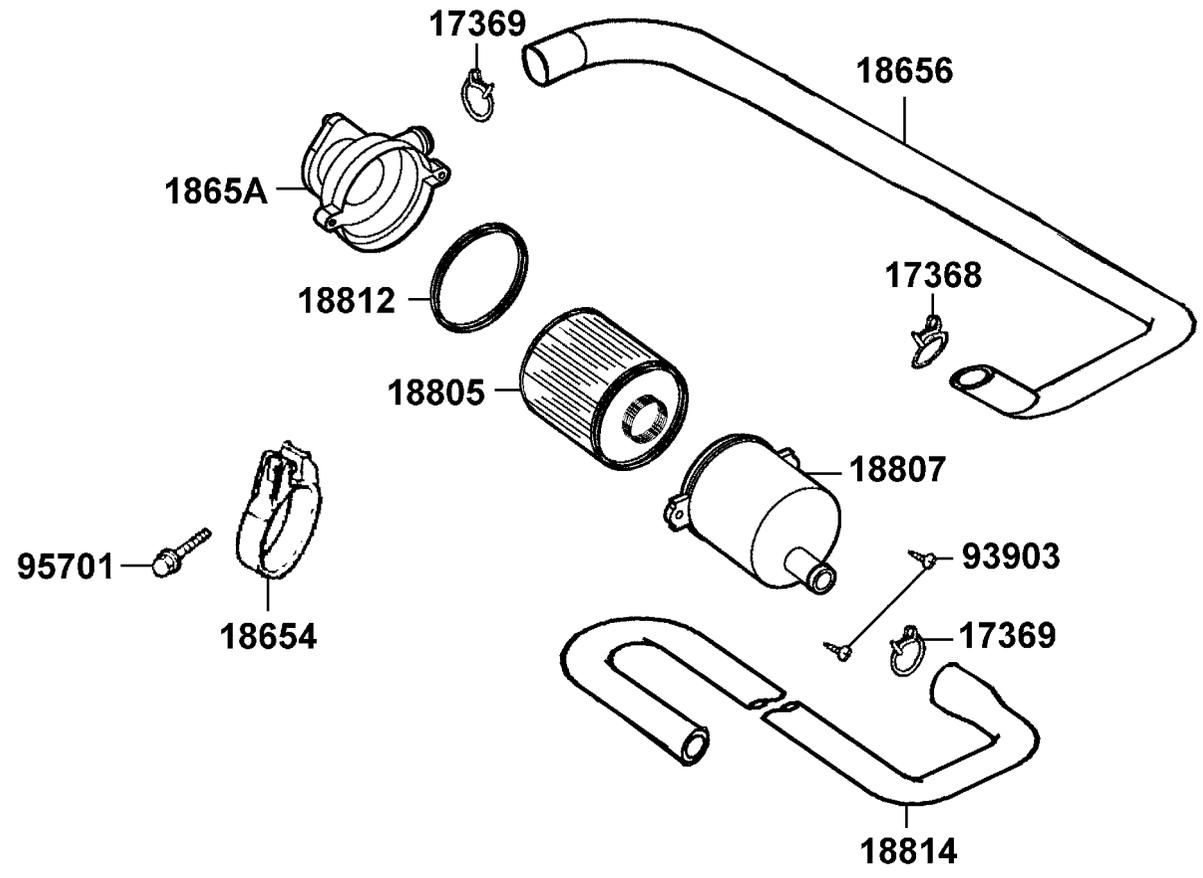



販賣記號	項目	零件號碼	版數	英文名稱	中文名稱	需要用量	參考價
Sales mark	Ref no	Part no	Ver	Description	Chinese	Regd no	Ref Price
		17368-KB4-6710	0	CLIP BREATHER TUBE	通氣管夾	1	
		17369-KB4-6700	1	CLIP BREATHER TUBE	通氣管夾	2	
		18654-KBG-9000	0	BAND AICV	二次空氣濾清器固定帶	1	
		18656-KEC8-900	0	DUCT AICV-REED VALVE	通氣管	1	
		1865A-KGBG-3050	1	ASSY AICV	二次空氣濾清器箱	1	
		18805-KE2-9000	1	ELEMENT AIR CLEANER	二次空氣濾清器濾蕊	1	
		18807-GY6-960	2	COVER A AIC-AICV	二次空氣濾清器蓋	1	
		18812-KE2-9000	0	SEAL AI CLEANER COVER	二次空氣濾清器防水封	1	
		18814-KEC8-900	0	DUCT AIR-AICV	通氣管	1	
		93903-24380	0	SCREW TAPPING 4*12	螺釘 4*12	2	
		95701-06016-08	0	BOLT FLANGE 6*16	螺絲 6*16	1	

**F 25** Separated Parts Of Fr Fork

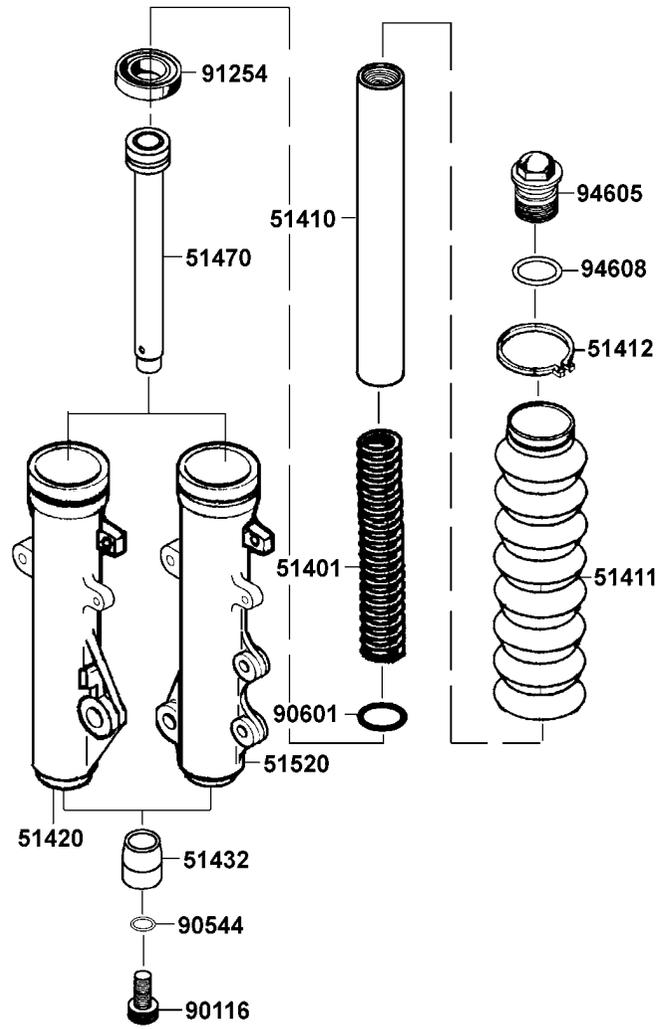

販賣記號	項目	零件號碼	版數	英文名稱	中文名稱	需要用量	參考價
Sales mark	Ref no	Part no	Ver	Description	Chinese	Regd no	Ref Price
		51401-KEC8-9000	0	SPRING	彈簧	2	
		51410-KEC8-9000	0	FORK PIPE COMP	前避震器管	2	
		51411-KEC8-9000	0	BOOT	護套	2	
		51412-KEC8-9000	0	BOOT BAND	束帶	2	
		51420-KEC8-9000	0	BOTTOM CASE R	右前避震器底管	1	
		51432-KEC8-9000	0	OIL LOCK PIECE	止油接頭	2	
		51470-KEC8-9000	0	PIPE SEAT COMP	避震器管座	2	
		51520-KEC8-9000	0	BOTTOM CASE L	左前避震器底管	1	
		90116-KEC8-9000	0	SOCKET BOLT	內六角螺絲	2	
		90544-KEC8-9000	0	PACKING	墊片	2	
		90601-KEC8-9000	0	OIL SEAL STOPPER RING	油封止位環	2	
		91254-KEC8-9000	0	OIL SEAL	油封	2	
		94605-KEC8-9000	0	FORK BOLT	螺絲	2	
		94608-KEC8-9000	0	O-RING	O環	2	

**F 26** Caution Label

Helmet  
Hook

87511

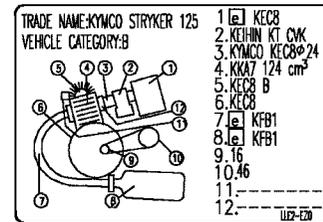

87224

USE UNLEADED GASOLINE ONLY

87501

Important instruction

Normal Tire Pressure : psi ( kg/cm<sup>2</sup> )

Front : 25 (1.75)	Rear : 32 (2.25)
One rider : Front : 25 (1.75)	Rear : 28 (2.0)
Tire size : Front : 90/90-21-4PR	
Rear : 130/80-17-4PR	

KEC8-F000

87505

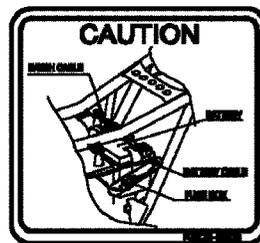

87506

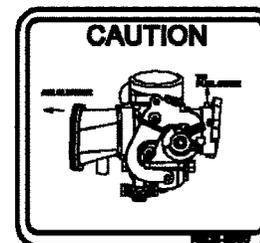

87507

販賣記號	項目	零件號碼	版數	英文名稱	中文名稱	需要用量	參考價
Sales mark	Ref no	Part no	Ver	Description	Chinese	Regd no	Ref Price
		87224-LLE2-EZ0	0	CAUTION ANTI TAMPERING	警告標示貼紙	1	
		87501-KDR-E00	0	CAUTION USE GAS ONLY	警告標示貼紙	1	
		87505-KEC8-E10	0	MARK TIRE CAUTION	胎壓警示標籤	1	
		87506-KEC8-E00	0	MARK BATTERY CAUTION	標籤	1	
		87507-KEC8-E00	0	MARK ACV CAUTION	標籤	1	
		87511-KAK-Q00	0	LABEL HELMET HOLDER	安全帽掛鉤標籤	1	

F 27 Emblem●Stripe

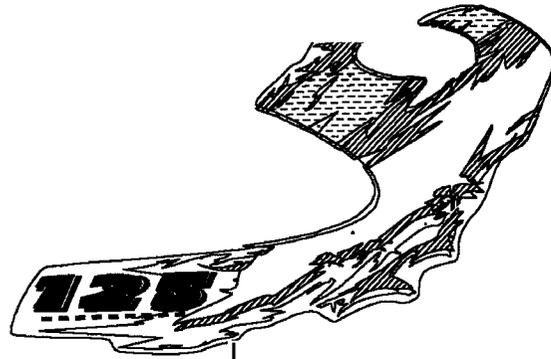

86103

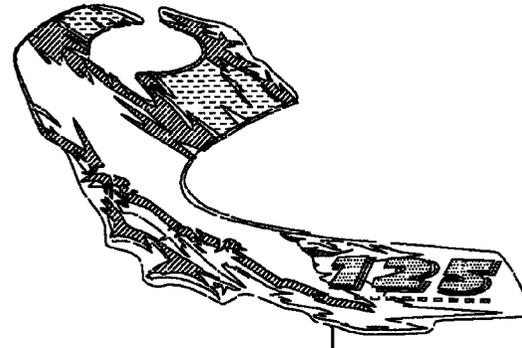

86133



86102



87311



86423



86433

販賣記號	項目	零件號碼	版數	英文名稱	中文名稱	需要用量	參考價
Sales mark	Ref no	Part no	Ver	Description	Chinese	Regd no	Ref Price
		86102-KFA6-E00	0	EMB K-LOGO 30MM	標誌	1	
**		86103-LLE2-E70	0	STRIPE R COWL	右罩貼紙	1	
**		86133-LLE2-E70	0	STRIPE L COWL	左罩貼紙	1	
		86423-LLE2-E70	0	STRIPE R BODY COVER	右邊蓋貼紙	1	
		86433-LLE2-E70	0	STRIPE L BODY COVER	左邊蓋貼紙	1	
		87311-KKD6-E00	0	STRIPE MARK EURO 2	EURO 2標誌	1	



零件號碼索引  
**PARTS NO. INDEX**





零件號碼索引

PART NO. INDEX

零件號碼 PART NO.	版數 VERSION	頁次 PAGE	零件號碼 PART NO.	版數 VERSION	頁次 PAGE	零件號碼 PART NO.	版數 VERSION	頁次 PAGE
15772-551-0000	1	P-83	17611-286-0010	0	P-83	18812-KE2-9000	0	P-125
16000			17620-KEC8-3250	0	P-83	18814-KEC8-900	0	P-125
1610K-LLE2-E000	0	P-47	17685-GY6-9400	0	P-83	22000		
16199-GY6-9000	0	P-47	1785-402H-0040-SB00	0	P-47	22100-324-0010	3	P-27
16210-KEC8-8000	0	P-15	17910-KEC8-9000	1	P-59	22100-KEC2-9000	3	P-39
16920-KEC8-8000	0	P-83	18000			22121-107-0110	2	P-27
16950-KEC8-9000	3	P-83	18231-365-6710	0	P-95	22125-KAK-9000	1	P-27
16955-KEC8-9000	0	P-83	18233-383-9000	1	P-95	22201-KAK-9000	0	P-27
16960-KEC8-9000	0	P-83	18291-166-0040	0	P-95	22202-KAK-9000	0	P-27
17000			18291-216-0010	1	P-95	22311-107-0010	0	P-27
17211-KEC8-9000	0	P-91	18291-KBE-9000	0	P-95	22350-107-0120	4	P-27
17219-KEC8-9000	0	P-91	18292-KBE-9000	0	P-95	22361-107-0010	0	P-27
17226-KEC8-9000	0	P-91	18293-KBE-9000	0	P-95	22366-383-0010	0	P-27
17228-KEC8-9000	0	P-91	18294-KBE-9000	0	P-95	22402-KAK-9000	1	P-27
1722B-KEC8-E00	0	P-91	18294-KCT-9000	0	P-95	22810-KEC2-9000	0	P-23
17236-KBF-9100	1	P-91	1830A-KFB1-EZ0	1	P-95	22816-355-0000	1	P-23
17236-KEC8-9000	0	P-91	18310-KFB1-EZ0	0	P-95	22821-355-0010	0	P-23
17254-KCA-P000	0	P-91	18318-KEC8-9000	0	P-95	22838-KEC2-9000	0	P-35
17256-KKC5-E000	0	P-15	18320-KFB1-EZ0	1	P-95	22850-355-0010	0	P-27
17265-KG7-0010	0	P-91	18321-KEC8-9000	0	P-95	22870-LLE3-E00	0	P-59
17266-KG7-0010	0	P-91	18601-KE2-9000	0	P-51	23000		
17360-GE1-9000	2	P-91	18612-KAK-9000	0	P-51	23121-KEC2-9000	0	P-25
17368-KB4-6710	0	P-125	18613-KAK-9000	0	P-51	23211-KEC2-9000	0	P-41
17369-KB4-6700	1	P-125	18645-GY6-9400	0	P-51	23221-KAK-9000	0	P-41
17504-KEC8-E000	1	P-83	18646-GY6-9400	0	P-51	23236-KEC2-9000	1	P-27
17505-KEC8-9000	0	P-83	18647-KAK-9000	0	P-51	23426-KAK-9000	0	P-41
17510-KEC8-E000	2	P-83	18654-KBG-9000	0	P-125	23427-439-0010	0	P-41
17520-KEC8-9000	0	P-83	18656-KEC8-900	0	P-125	23431-439-0010	0	P-41
17560-KEC8-900	0	P-83	18657-KEC8-900	0	P-15	23441-KAK-9000	0	P-41
			1865A-KGBG-3050	1	P-125			
			18805-KE2-9000	1	P-125			
			18807-GY6-960	2	P-125			

零件號碼索引

PART NO. INDEX

零件號碼 PART NO.	版數 VERSION	頁次 PAGE	零件號碼 PART NO.	版數 VERSION	頁次 PAGE	零件號碼 PART NO.	版數 VERSION	頁次 PAGE					
23451-KAK-9000	0	P-41	28125-426-0010	0	P-29	32000							
23461-439-001	3	P-41	28126-KDU-900	0	P-29								
23471-439-001	1	P-41	28130-KE2-9810	0	P-29								
23481-439-0010	1	P-41	28132-KG7-0010	0	P-29								
23491-439-0010	0	P-41	28211-397-0110	0	P-41								
23501-KKA8-9000	0	P-41	28221-397-0210	0	P-41								
23511-KKA8-9000	0	P-41	28251-397-0110	1	P-41								
23520-KEC2-9000	0	P-41	28253-397-0010	0	P-43								
23531-439-0010	0	P-41	28261-397-0010	2	P-43								
23801-KAK-9000	0	P-41	28262-397-0010	0	P-43								
23811-KR3-6010	0	P-41	28263-397-0010	0	P-43	33000							
24000			28270-397-0210	0	P-43								
			2830A-KEC8-9000	0	P-99								
			24211-107-0020	0	P-45				30000				
			24221-355-0020	0	P-45								
			24231-107-0110	0	P-45								
			24241-107-0010	0	P-45								
			24301-KAK-9000	2	P-45								
			24411-KAK-9000	0	P-45								
			24430-324-0010	0	P-45								
			24435-KAK-9000	0	P-45								
24610-KC6-0010	1	P-45											
24621-107-7610	0	P-45											
24631-107-0010	0	P-45	31000										
24651-398-9410	0	P-45											
24700-KEC8-9000	0	P-99											
28000								31110-KE2-9600	1	P-29			
								31120-KBH-9000	0	P-29			
								31200-KAK-9000	0	P-29			
								31241-KE2-9810	1	P-29			
								31500-GY6-9410-M1	2	P-117			
								31500-GY6-94B	5	P-117			
								31600-KR1-76A-D418	0	P-117			
			31600-KR1-76A-D421	0	P-117								
			31700-KEC8-E000	0	P-117								
			28110-KKA7-900	1	P-29	34000							
28114-KKA7-9000	1	P-29											
28120-GY6-315	1	P-29											
24000			32100-LLE2-E00	2	P-117								
			32101-KHE7-E000	0	P-29								
			32401-KEC8-9000	0	P-117								
			32402-KEC8-9000	1	P-117								
			32410-LLE2-E00	0	P-29								
			32976-107-0010	0	P-29								
			33100-KEC8-9000	0	P-55								
			33120-KEC8-9000	0	P-55								
			33130-KEC8-9000	0	P-55								
			33400-KEC8-9000	0	P-113								
33450-KEC8-9000	0	P-113											
33600-KEC8-9000	0	P-113											
33602-KCP-9000	1	P-113											
33650-KEC8-9000	0	P-113											
33652-KCP-9000	1	P-113											
33700-KEC8-9000	2	P-115											
33702-KEC8-9000	0	P-115											
33741-GY6-C300	1	P-71											
33741-KEC8-9000	0	P-115											
24000			34901-KAB-9000	0	P-55								
			34905-KCP-9000	0	P-113								
			34906-KCP-9000	0	P-115								
			34908-GA7-7010-M1	1	P-57								
			34908-KCU-9000	0	P-55								

零件號碼索引

PART NO. INDEX

零件號碼 PART NO.	版數 VERSION	頁次 PAGE	零件號碼 PART NO.	版數 VERSION	頁次 PAGE	零件號碼 PART NO.	版數 VERSION	頁次 PAGE
34908-MB9-8710-M1	0	P-57	38301-GW0-9010	0	P-57	43120-KG7-0020	3	P-77
35000			40000			43141-KEC8-9000	0	P-77
35010-KEC8-E000	0	P-117	4000-069-0004	0	P-49	43215-KBE-9000	0	P-73
35100-KEC8-3050	0	P-117	40510-KEC8-9000	0	P-103	43352-568-0030	3	P-73
3515A-KEC8-9000	0	P-59	40520-KEC8-9000	0	P-103	43353-461-7710-M1	0	P-73
3520A-KEC8-E000	1	P-59	40530-KEC8-9000-M1	0	P-103	43410-KEC8-9000	0	P-77
35340-GY6-9100	0	P-59	40543-KEC8-9000	0	P-103	43431-KEC8-9000	0	P-103
35340-KBN-9000	0	P-59				43434-286-0010	0	P-103
35350-KE2-941	0	P-117				43451-KEC8-9000	1	P-99
35357-KEC8-9000	0	P-99	41000			43452-KEC8-9000	0	P-99
35370-KEC8-E000	1	P-103				44000		
35753-028-6020	0	P-45	4115-803-1100	0	P-49	44301-KHB4-9000	0	P-75
3575A-001-0200	0	P-35	4115-804-1100	0	P-49	44311-KAK-9000	0	P-75
35850-KAK-9000	1	P-117	4120A-KEC8-9000	0	P-79	4460A-KEC8-8000	0	P-75
35850-KAK-9000-M1	1	P-117	41241-307-0110	0	P-79	44620-400-0000	1	P-75
37000			42000			44680-410-0010	0	P-75
37200-KEC8-9000	2	P-57	42301-KEC8-900	2	P-79	44701-KEC8-8000	0	P-75
37710-KGBG-E000	0	P-47	42311-KEC8-9000	0	P-79	44711-KEC8-80B	0	P-75
37720-KGBG-E000	0	P-47	42313-KEC8-9000	0	P-79	44712-KEC8-80B	0	P-75
37760-KGBG-E100	0	P-117	42600-KEC8-3050	0	P-79	44800-KEC8-800	1	P-75
37801-GA7-7000	1	P-83	42620-KEC2-9000	0	P-79	44830-KEC8-9000	4	P-57
37802-KEC8-9000	0	P-83	42701-KEC8-8000	0	P-79	45000		
3780A-KEC8-9000	0	P-83	42711-KEC8-80B	0	P-79	45107-MN5-0070	0	P-73
38000			42712-KEC8-80B	0	P-79	45108-ML4-0060	2	P-73
38110-KBE-9000-M1	1	P-117	43000			45109-GE2-0060	0	P-73
38205-115-0010	0	P-117	43100-KG7-8320	0	P-77	45121-KW6-9010	2	P-75
						45126-KEC8-9000	0	P-59
						45128-KBE-9000	0	P-71
						45128-KEC8-9000	0	P-71

零 件 號 碼 索 引

PART NO. INDEX

零 件 號 碼 PART NO.	版 數 VERSION	頁 次 PAGE	零 件 號 碼 PART NO.	版 數 VERSION	頁 次 PAGE	零 件 號 碼 PART NO.	版 數 VERSION	頁 次 PAGE
45131-166-0160	0	P-73	50191-KEC8-9000	0	P-121	51500-KEC8-9000	3	P-71
45131-GE2-0060	1	P-73	50351-KEC8-9000	0	P-121	51520-KEC8-9000	0	P-127
45132-166-0160	0	P-73	50351-LLE3-E00	1	P-121			
45133-240-0000	1	P-77	50353-KEC8-9000	2	P-121			
45133-MA3-0060	0	P-73	50354-KEC8-9000	0	P-121	52000		
45134-250-0000	0	P-77	50356-KEC8-9000	1	P-121			
45150-KEC8-3050	0	P-73	50357-KEC8-9000	1	P-121	52108-KE5-0040	0	P-103
45156-KEC8-9000	0	P-63	50530-KEC8-E000	0	P-103	52108-KW6-9010	0	P-103
45200-KEC8-900	0	P-73	50535-KEC8-E000	0	P-103	52110-KEC8-9000	0	P-103
45209-GE2-0060	0	P-73	50548-324-7610-01	0	P-103	52141-KEC8-9000	0	P-103
45210-KEC8-9000	0	P-73	50549-356-7000	0	P-103	52144-GE2-0060	0	P-103
45215-KCE-9000	0	P-73	50613-KEC8-900	0	P-89	52171-KEC8-9000	0	P-103
45216-166-0060	0	P-73	50630-KEC8-9000	0	P-99	52172-KEC8-9000	1	P-103
45216-KW6-9020-M1	0	P-73	50631-KEC8-9000	0	P-99	52173-KEC8-9000	0	P-103
45513-KAK-9010	0	P-59	50632-KEC8-9000	0	P-99	52200-KEC8-9000	0	P-103
45517-KAK-9000	0	P-59	50633-KEC8-9000	0	P-99	52207-KEC8-9000	0	P-105
45517-KFA5-E000-IT	0	P-59	50634-KEC8-9000	0	P-99	52208-KEC8-9000	0	P-105
45530-KAK-3060	0	P-59	50635-KEC8-9000	0	P-99	52209-KEC8-9000	0	P-105
45531-GR1-9510	0	P-73	50640-KEC8-9000	0	P-99	52241-KEC8-9000	0	P-105
			50700-KEC8-3050	0	P-121	52242-KEC8-9000	0	P-105
			50710-086-3150-M1	0	P-121	52243-KEC8-9000	0	P-105
46000			50714-KEC8-9000	0	P-121	52244-KEC8-9000	0	P-105
			50715-KEC8-9000	0	P-121	52300-KEC8-9000	0	P-105
46501-KEC8-900	1	P-99				52400-KEC8-900	0	P-109
46503-KEC8-9000	0	P-99						
46514-KEC8-9000	0	P-99	51000					
						53000		
50000			51400-KEC8-9000	3	P-71			
			51401-KEC8-9000	0	P-127	53100-KEC8-9000	0	P-63
			51410-KEC8-9000	0	P-127	53102-KEC8-9000	0	P-63
50100-LLE3-E00	4	P-121	51411-KEC8-9000	0	P-127	53131-439-0010	0	P-63
50133-KEC8-9000	0	P-99	51412-KEC8-9000	0	P-127	53132-439-0000	0	P-63
50134-KEC8-9000	0	P-99	51420-KEC8-9000	0	P-127	53133-236-0000	0	P-63
5017A-KEC8-9000	0	P-91	51432-KEC8-9000	0	P-127	53134-283-0010	0	P-63
50190-KEC8-9000	1	P-121	51470-KEC8-9000	0	P-127	53140-KEC8-9000	0	P-59

零件號碼索引

PART NO. INDEX

零件號碼 PART NO.	版數 VERSION	頁次 PAGE	零件號碼 PART NO.	版數 VERSION	頁次 PAGE	零件號碼 PART NO.	版數 VERSION	頁次 PAGE
53166-KEC8-9000	0	P-59	64301-KEC8-900	0	P-63	83550-KEC8-9000	0	P-89
53167-KW6-9010	1	P-59	64302-KEC8-900	0	P-63	83551-KAK-9000	0	P-89
53168-KW6-9010	0	P-59	64303-KAQ-9000	0	P-65	83551-KEC8-9000	0	P-65
53172-KEC8-9000	0	P-59	64303-KEC8-900	0	P-65	83551-KEC8-9000	0	P-87
53175-KAK-900	3	P-59	64304-KEC8-900	0	P-65	83551-KEC8-9000	0	P-89
53178-KEC8-900	1	P-59	64305-KEC8-900	0	P-65	83600-KEC8-900	0	P-89
53192-268-0010	0	P-59				83610-LLE2-305	0	P-89
53200-KEC8-9000	0	P-63						
53204-KEC8-9000	0	P-63	77000					
53205-KEC8-9000	0	P-63				86000		
53214-KEC8-9000-M1	0	P-63	77115-LLE2-305	0	P-87			
53227-KEC8-800	0	P-59	77116-LLE2-305	0	P-87	86102-KFA6-E00	0	P-131
5322A-KEC8-9000	0	P-63	77200-KEC8-900	0	P-87	86103-LLE2-E70	0	P-131
53230-KEC8-9000	0	P-63				86133-LLE2-E70	0	P-131
53237-KEC8-800	0	P-61				86423-LLE2-E70	0	P-131
53240-KEC8-9000	0	P-63	80000			86433-LLE2-E70	0	P-131
			80101-KEC8-8000	0	P-111			
55000			80102-KEC8-9000	0	P-111	87000		
55102-166-0010	0	P-83				87224-LLE2-EZ0	0	P-129
			81000			87311-KKD6-E00	0	P-131
61000			81200-KEC8-900	0	P-115	87501-KDR-E00	0	P-129
61110-KEC8-800	0	P-69	81201-KEC8-9000	0	P-115	87505-KEC8-E10	0	P-129
			81210-KEC8-900	0	P-115	87506-KEC8-E00	0	P-129
			81220-KEC8-9000	0	P-115	87507-KEC8-E00	0	P-129
64000						87511-KAK-Q00	0	P-129
64110-KEC8-9000	0	P-63	83000					
64111-KEC8-9000	0	P-69	83500-KEC8-900	0	P-89	88110-KEC8-E000	0	P-61
64206-KBN-9000	0	P-63	83510-LLE2-305	0	P-89			
64206-MJ0-0010	0	P-63	83550-KEC8-9000	0	P-65			
6422A-KEC8-9000	0	P-63	83550-KEC8-9000	0	P-87			

零 件 號 碼 索 引

PART NO. INDEX

零 件 號 碼 PART NO.	版 數 VERSION	頁 次 PAGE	零 件 號 碼 PART NO.	版 數 VERSION	頁 次 PAGE	零 件 號 碼 PART NO.	版 數 VERSION	頁 次 PAGE
89000			90116-KEC8-9000	0	P-127	90451-365-0010	0	P-43
89010-KN7-C000	1	P-89	90121-KEC8-900	2	P-105	90452-107-0010	0	P-43
8910A-KEC8-9000	0	P-89	90122-KHC7-C000-ZF	0	P-73	90453-107-0020	0	P-43
90000			90128-KEC8-9000	0	P-79	90453-235-0010	0	P-43
90001-GHB-6610	0	P-19	90131-KBE-9000	0	P-99	90454-107-0010	0	P-43
90001-KAK-9000	0	P-35	90145-MS9-6120-M1	0	P-61	90455-107-0010	0	P-43
90005-KEC8-9000	1	P-19	90206-250-0010	0	P-19	90459-107-0010	0	P-43
90012-415-0010	0	P-19	90231-200-0110	1	P-25	90461-107-0010	0	P-27
90019-399-0110	1	P-121	90231-KEC2-9000	1	P-39	90462-107-0010	0	P-43
90023-KG7-0010	0	P-29	90301-473-0040	0	P-75	90465-MC4-0010	0	P-19
90031-KBE-9000	0	P-35	90301-634-6700	0	P-71	90474-147-0010	0	P-31
90081-KAK-9000	0	P-35	90302-GY6-9010	0	P-61	90501-KBN-9010	0	P-79
90084-428-0010	0	P-15	90302-GY6-9010	0	P-83	90503-051-8700	0	P-65
90084-KAK-9000	0	P-31	90302-GY6-9010	0	P-89	9052A-GY6-9500	0	P-35
90087-KAK-9000	1	P-31	90302-GY6-9010	0	P-105	90544-KEC8-9000	0	P-127
90101-KEC8-9000	1	P-121	90302-GY6-9010	0	P-117	90545-300-0010	2	P-61
90103-KEC8-9000	0	P-83	90302-GY6-9400	0	P-69	90549-121-0000	0	P-77
90105-KEC8-9000	0	P-115	90302-GY6-9400	0	P-83	90601-KEC8-9000	0	P-127
90106-KFC2-9000	0	P-65	90302-GY6-9400	0	P-111	90605-200-0010	0	P-43
90108-KEC8-E000	0	P-105	90302-KEC8-9000	0	P-65	90652-GY6-9010	0	P-91
90110-GW0-0010	0	P-87	90302-KEC8-9000	0	P-87	90664-216-9000	0	P-79
90110-KBE-9000	0	P-95	90304-GE8-0040	0	P-105	90667-KEC8-9000	0	P-71
90110-KEB7-9000	0	P-65	90304-GE8-0040	0	P-109	90668-KEC8-9000	0	P-71
90110-KEB7-9000	0	P-105	90304-GE8-0040	0	P-121	90677-GR1-0030	1	P-65
90111-147-0000	0	P-115	90304-HB3-7720-M1	0	P-95	90677-GR1-0030	1	P-111
90111-KEC8-9000	0	P-87	90304-KAK-9000	1	P-65	90757-439-9310	0	P-79
90112-KDR-9000	0	P-117	90305-GE8-9010	0	P-105			
90112-KEC8-9000	0	P-89	90305-KW6-9120-M1	0	P-79			
90113-KEC8-8000	0	P-61	90306-KF0-901	0	P-75	91000		
90114-KEC8-8000	0	P-61	90306-KF0-901	0	P-105			
			90321-315-6710	0	P-61	91001-KEC8-9000	0	P-39
			90321-KN7-9110	0	P-65	91021-148-0050	0	P-31
			90443-KEC2-9000	0	P-39	91021-148-0050	0	P-35
			90451-001-0010	0	P-45	91101-179-7110-M1	0	P-31
			90451-107-0000	1	P-43	91104-KEC8-9000-M1	0	P-31

零件號碼索引

PART NO. INDEX

零件號碼 PART NO.	版數 VERSION	頁次 PAGE	零件號碼 PART NO.	版數 VERSION	頁次 PAGE	零件號碼 PART NO.	版數 VERSION	頁次 PAGE
91106-KHC4-9000-M1	0	P-35	93500-04008-1H	0	P-49	94050-06080	0	P-25
91106-KHC4-9000-M2	0	P-35	93500-04010-1H	0	P-49	94050-06080	0	P-57
91201-030-0330	0	P-35	93500-04012-1H	0	P-49	94050-06080	0	P-61
91204-259-0060	0	P-23	93500-04030-0G	0	P-61	94050-06080	0	P-99
91206-286-0140	0	P-35	93500-04045-0G	0	P-61	94050-06080	0	P-115
91252-030-0000	0	P-75	93500-05016-0H	0	P-31	94050-06080	0	P-119
91254-KEC8-9000	0	P-127	93500-05022-0G	0	P-61	94050-08080	0	P-19
91258-410-0000-M2	0	P-75	93500-06014-0B	0	P-105	94050-08080	0	P-85
91301-KE2-710	0	P-23	93500-06050-0H	0	P-35	94050-10080	0	P-113
91302-200-0010	0	P-15	93600-04012-1A	0	P-61	94050-KBE2-9000	0	P-121
91302-567-0040	0	P-31	93700-05012-0H	0	P-25	94101-06000	0	P-95
91303-107-0000	1	P-35	93891-05012-07	0	P-91	94101-06800	0	P-121
91303-377-0010	0	P-17	93891-05016-07	0	P-55	94101-08800	0	P-101
91303-377-0010	0	P-31	93891-05016-08	0	P-91	94101-08800	0	P-107
91306-105-6910	0	P-19	93892-04008-18	0	P-49	94102-14800	0	P-85
91307-035-0010	0	P-23	93893-04012-18	0	P-61	94103-06700	0	P-57
91359-371-0040	0	P-31	93901-34420	0	P-115	94108-KEC8-9000	0	P-79
			93903-24380	0	P-125	94111-10800	0	P-107
			93903-25280	0	P-55	94201-16151	0	P-101
92000			93903-25280	0	P-69	94201-20120	0	P-101
			93903-25380	0	P-91	94201-20151	0	P-23
92000-06010-0H	0	P-43	93903-34380	0	P-65	94201-20151	0	P-107
92000-06020-0H	0	P-45	93903-34380	0	P-89	94251-06400	0	P-121
92000-06025-0H	0	P-45	93903-34380	0	P-115	94251-08400	0	P-25
92101-06020-0H	0	P-99	93903-34480	0	P-57	94301-08140	0	P-23
92201-05025-0H	0	P-31	93903-35380	0	P-65	94301-10140	0	P-31
92700-06035-3E	0	P-17				94301-10140	0	P-35
92811-KAK-9000	2	P-105				94301-10140	0	P-51
92812-KCD-9000	1	P-105	94000			94301-10160	0	P-17
92912-06018-0E	0	P-75				94301-10160	0	P-37
			94001-06080-0S	0	P-95	94401-25140-M1	0	P-39
			94001-08080-0S	0	P-105	94401-KEC2-9000	0	P-39
93000			94001-10080-0S	0	P-65	94510-12000	0	P-45
			94002-10080-0S	0	P-105	94510-14000	0	P-45
93404-06020-07	0	P-115	94031-10080	0	P-79	94510-16000	0	P-43



零件號碼索引

PART NO. INDEX

零件號碼 PART NO.	版數 VERSION	頁次 PAGE	零件號碼 PART NO.	版數 VERSION	頁次 PAGE	零件號碼 PART NO.	版數 VERSION	頁次 PAGE
94510-20000	0	P-27	95701-06022-08	0	P-77	96001-06016-02	0	P-51
94510-20000	0	P-43	95701-06025-08	0	P-51	96001-06016-02	0	P-97
94524-47000	0	P-79	95701-06028-02	0	P-31	96001-06016-08	0	P-17
94601-15000-M1	0	P-39	95701-06028-08	0	P-17	96001-06018-08	0	P-21
94605-KEC8-9000	0	P-127	95701-06040-02	0	P-51	96001-06020-02	0	P-31
94608-KEC8-9000	0	P-127	95701-06045-08	0	P-119	96001-06020-02	0	P-61
			95701-08012-08	0	P-95	96001-06025-08	0	P-31
			95701-08012-08	0	P-119	96001-06028-02	0	P-31
95000			95701-KEB7-E000	1	P-17	96001-06032-08	0	P-25
			95701-KEC8-E000	0	P-119	96001-06040-02	0	P-23
95002-02070	0	P-17	95799-06025-07	0	P-107	96001-06040-02	0	P-31
95002-02080	0	P-85	95801-08020-08	0	P-115	96001-06050-02	0	P-23
95002-02100	0	P-85	95801-08020-08	0	P-121	96001-06050-02	0	P-31
95002-02120	0	P-91	95801-08032-07	0	P-101	96001-06110-08	0	P-17
95002-50000	0	P-85	95801-08035-08	0	P-65	96100-60010-00	0	P-27
95005-KG7-9010	0	P-91	95801-08035-08	0	P-101	96100-60060-00	0	P-37
9500B-KEC8-9000	0	P-17	95801-08040-08	0	P-65	96100-62030-00	0	P-37
9500C-KEC8-9000	0	P-85	95801-08040-08	0	P-107	96100-62040-00	0	P-37
95014-73100	0	P-101	95801-08045-07	0	P-67	96100-63030-00	0	P-37
95014-75110-M1	0	P-27	95801-08070-08	0	P-123	96120-62020-00	0	P-37
95015-32001	0	P-101	95801-08085-08	0	P-123	96140-63010-10	0	P-75
95015-42000	0	P-101	95801-10040-08	0	P-109	96140-63030-10	0	P-79
95015-KEC8-9000	0	P-101	95801-10075-08	0	P-107	96201-KEC8-9000	0	P-107
95701-06012-08	0	P-65	95801-10075-08	0	P-109	96220-40100-M1	0	P-45
95701-06012-08	0	P-71	95801-12080-08	0	P-107	96220-60100	0	P-33
95701-06012-08	0	P-93				96600-08015-10	1	P-33
95701-06012-08	0	P-115						
95701-06014-08	0	P-71	96000					
95701-06016-08	0	P-89				97000		
95701-06016-08	0	P-119	96001-06012-02	0	P-51			
95701-06016-08	0	P-125	96001-06012-02	0	P-95	97000-56200	0	P-75
95701-06020-08	0	P-65	96001-06012-08	0	P-21	97000-56200	0	P-79
95701-06020-08	0	P-87	96001-06012-08	0	P-25	97280-51270-10	0	P-75
95701-06020-08	0	P-101	96001-06012-08	0	P-31	97550-51269-10	0	P-75
95701-06022-08	0	P-27	96001-06014-02	0	P-31	97612-62130-10	0	P-81

零件號碼索引

PART NO. INDEX

零件號碼 PART NO.	版數 VERSION	頁次 PAGE	零件號碼 PART NO.	版數 VERSION	頁次 PAGE	零件號碼 PART NO.	版數 VERSION	頁次 PAGE
97874-62129-10	0	P-81						
98000			Y					
98069-5771R	0	P-17	Y1901-001-3700	0	P-49			
98200-11500	0	P-119	Y1901-002-0200	0	P-49			
99000			Z					
99101-116-1080	0	P-49	Z062-0060	0	P-49			
K								
K446-A31-0100	0	P-49						
N								
N413-18C00	0	P-49						
N424-45A35	0	P-49						
N425-4HLNL	0	P-49						
N426-33C00	0	P-49						
W								
W1470-MW0-7500	0	P-49						
W9353-36000	0	P-49						
W9525-25250	0	P-49						