

PARTS CATALOGUE



MOTORCYCLES

KB20BG(TK)

ACTIV 110



Release Date : 2011/03/03
Print Date : 2011/07/12

ABOUT THIS PARTS LIST

- This parts list is compiled all service parts for model KB20BG(TK).
- Any difference between color chart and motorcycle will be revised according to motorcycle.
- The Mark:
 1. Marking "***" must add color code in the end before ordering parts.
 2. Marking "#" are parts with modification, Please find the details from e-Parts system.
- When modification or additions to this parts list are made a revised edition at an appropriate time.



CONTENTS

● ABOUT THIS PARTS LIST	1
● COLOR CHART OF KB20BG(TK)	3
● CONTENTS-ENGINE GROUP	6
● CONTENTS-FRAME GROUP	9
● ENGINE PARTS LIST	13
● FRAME PARTS LIST	57
● PART NO. INDEX	115

NO	MODEL			COLOR CHART OF KB20BG(TK)			
	PHOTO NO			NO. 1	NO. 2	NO. 3	NO. 4
	BASIC COLOR			Bright Silver/Black	Bright Silver	Bright Silver/Bright Red	Bright Silver/Blue
	CODE			Bright Silver/Black	Bright Silver	Bright Silver/Bright Red	Bright Silver/Blue
	PARTS NAME	PARTS NO.	VERSION	NH045MAB	NH045MAA	NH045MAC	NH045MAD
1	COVER R SIDE	83510-LBA8-307	0	A60		A61	A62
2	COVER L BODY SIDE	83610-LBA8-307	0				
3	COVER R SIDE	83510-LBA8-C10	1	D0B			
4	COVER L SIDE	83610-LBA8-C10	0				
5	COVER RR HANDLE	53206-LBA8-C10	0	N1P			
6	COVER CENTER UP	80151-LBA8-C10	0				
7	COVER CENTER LOW	80152-LBA8-C10	2				
8	LEG SHIELD	81131-LBA8-C10	0				
9	CASE BATTERY	50325-LBA8-C10	0	N1R			
10	COVER BATTERY	50326-LBA8-C10	0				
11	FENDER RR A	80105-LBA8-C10	0				
12	FENDER RR B	80106-LBA8-C10	0				
13	BOX LUGGAGE	81250-LBA8-C10	2	N1F			
14	COVER R BODY	83500-LBA8-306	0				
15	COVER L BODY (NH045)	83600-LBA8-306	0	N1F	N8A	N8B	N8C
16	CRANK CASE COMP	11100-LBA8-C10	1	N8A			
17	COVER COMP R CRANK	11330-LBA8-C10	0				
18	COVER R MARK	11336-LBA8-C10	0				
19	HOLE CAP TAPPET	12361-0E35-E80	0				
20	COVER CYL HEAD SIDE	12440-LBA8-C10	0				
21	PANEL ASSY RR BRK	43000-LBA8-E80	0				
22	LEVER HANDLE	53175-LBA8-C11	0				
23	CAP ACG	90084-LBA8-E80	0				
24	CAP 30MM	90087-4H28-E80	0				
25	COVER FR (NH045)	64301-LBA8-307	0				
DATE OF STARTING-SALES							
DATE OF END-SALES							

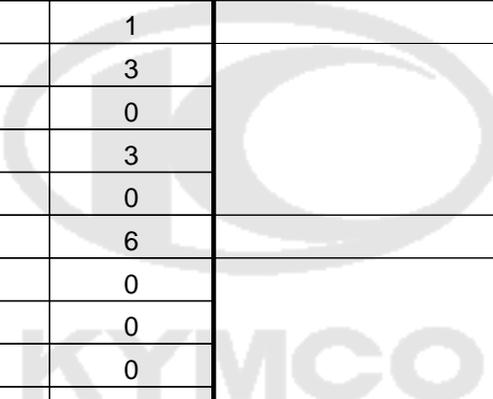
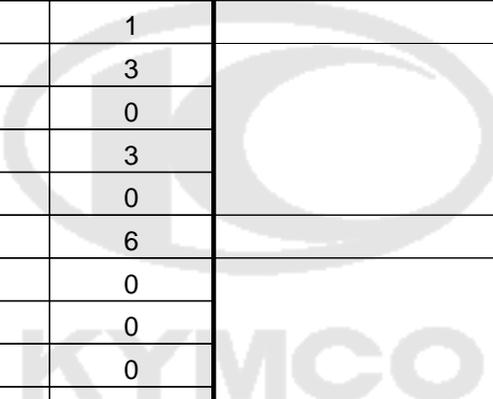
NO	MODEL			COLOR CHART OF KB20BG(TK)				
	PHOTO NO			NO. 1	NO. 2	NO. 3	NO. 4	
	BASIC COLOR			Bright Silver/Black	Bright Silver	Bright Silver/Bright Red	Bright Silver/Blue	
	CODE			Bright Silver/Black	Bright Silver	Bright Silver/Bright Red	Bright Silver/Blue	
	PARTS NAME	PARTS NO.	VERSION	NH045MAB	NH045MAA	NH045MAC	NH045MAD	
26	COVER FR	64301-LBA8-C10	0	D0B	N8P	D0G	D0E	
27	FENDER A FR	61100-LBA8-900	0	N1P	N8P	R9P	B4P	
28	FENDER B FR	61101-LBA8-900	0					
29	COVER FR HANDLE	53205-LBA8-305	0					
30	COVER FR HANDLE	53205-LBA8-C10	0					
31	COVER R BODY	83500-LBA8-C10	0					N8P
32	COVER L BODY	83600-LBA8-C10	0					
33	COVER RR CENTER	83750-LBA8-C10	0					
34	HEAD COMP CYLINDER	12200-LBA8-C10	1					NEA
35	WHEEL ASSY RR	42601-LBA8-C11	3					
36	SPRKT HUB ASSY	42610-LFD6-C50	0					NJA
37	GEAR BOX ASSY	44800-LBA8-C11	3					
38	CALIPER ASSY FR	45200-LBA8-C10	0					
39	FORK COMP RR	52110-LBA8-E80	6	NJS				
40	SEAT ASSY	77200-LBA8-E80	0					
41	EMB ACTIVE 110	86404-LBA8-E80	0					
42	STRIPE B R BODY	86443-LBA8-E80	0					
43	STRIPE B L BODY	86453-LBA8-E80	0					
44	CAUTION ANTI-	87224-LBA8-E80	1					T01
45	STRIPE MARK EUR02	87311-KKD6-E00	0					
46	LABEL TIPE	87505-KGC4-C10	1					
47	MARK KYMCO	87552-KQCQ-C00	4					
48	MARK DRIVE CAUTION	87560-GFY6-C01	3					
49	STRIPE R FR COVER	86121-LBA8-E80	0					T01
50	STRIPE L FR COVER	86131-LBA8-E80	0					
DATE OF STARTING-SALES								
DATE OF END-SALES								

CONTENTS - ENGINE GROUP

<p>E10 Crankcase left Cover</p>	<p>E11 Magneto</p>	<p>E12 Coupling coat</p>
<p>E13 Starting Motor</p>	<p>E14 Crank Case</p>	<p>E15 Crankshaft Piston</p>
<p>E16 Transmission</p>	<p>E17 Speed change foot bar</p>	<p>E18 Has moving axis</p>

CONTENTS - ENGINE GROUP

E19 Carburetor

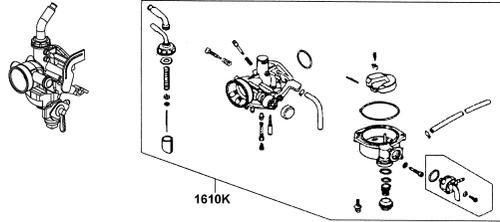

CONTENTS - FRAME GROUP

F01 Head Light

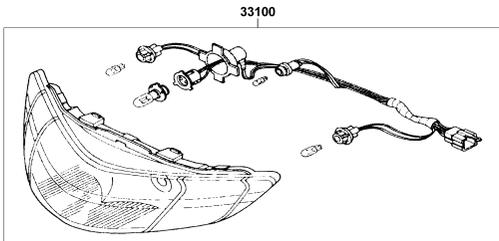

F02 Speedometer

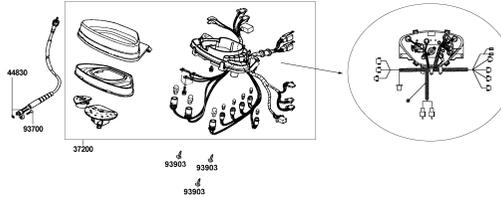

F03 Back Mirror/Handle rod

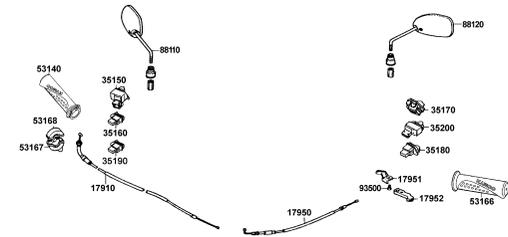

F04 Front brake cylinder

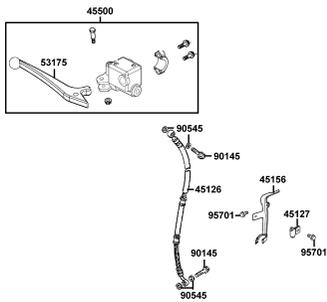

F05 Changes handle handle

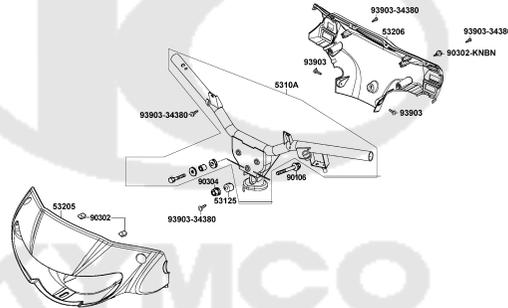

F06 Stem Steering

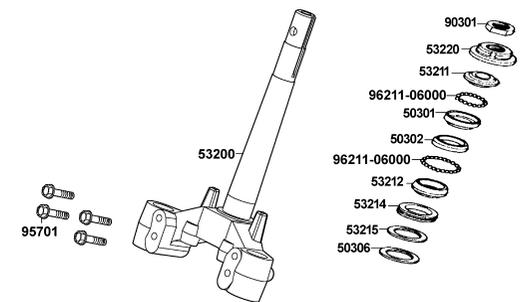

F07 Front Fender

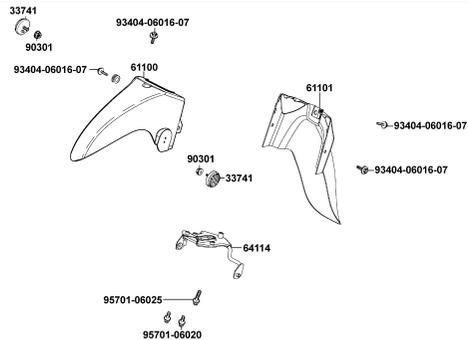

F08 Front Fork

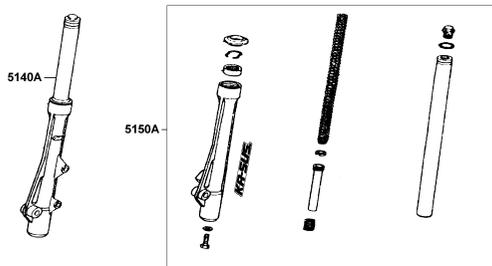

F09 Front brake calibre

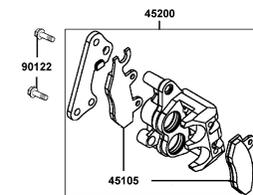

CONTENTS - FRAME GROUP

F19 Treads foot

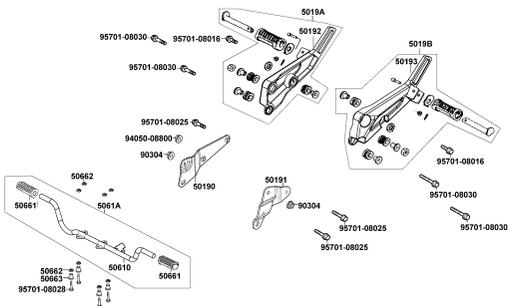

F20 Foot rest

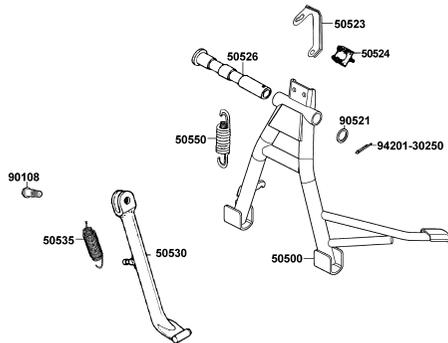

F21 Lateral forks

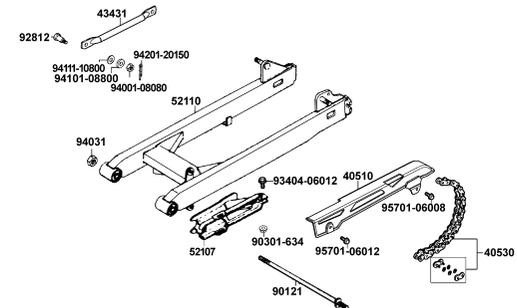

F22 Rear Cushion

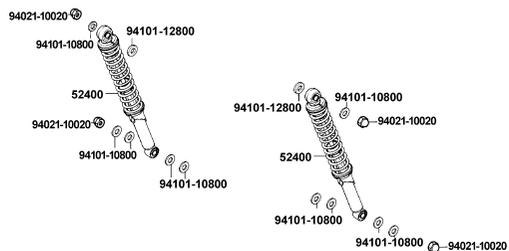

F23 Rear Fender

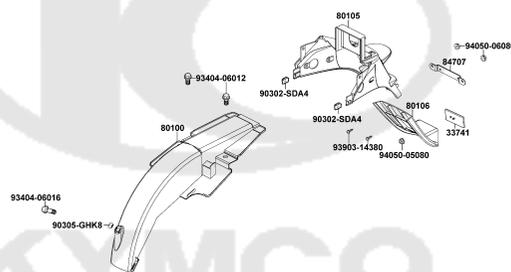

F24 Winker Tail Light

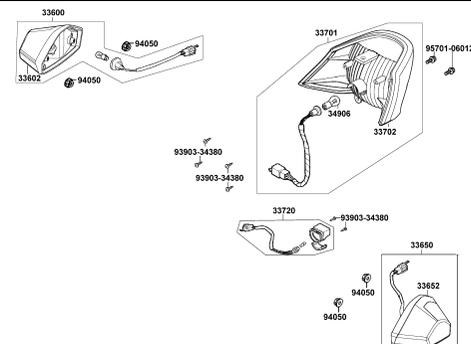

F25 Battery

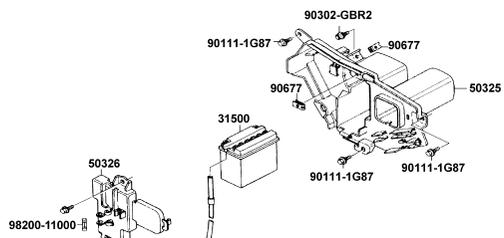

F26 Harness Wire

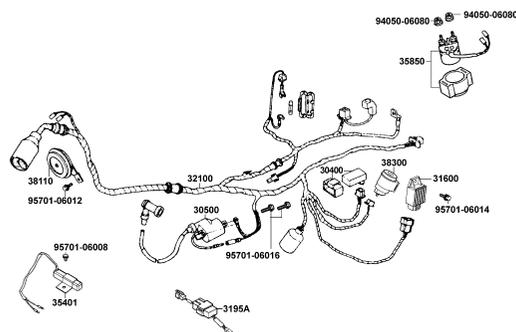

F27 Frame Body

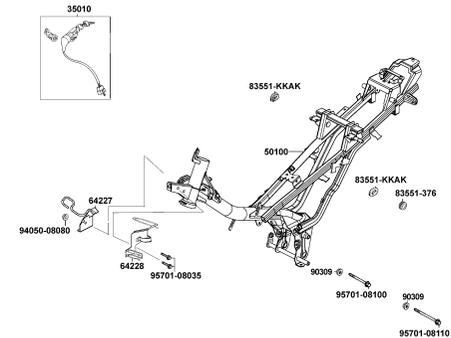

CONTENTS - FRAME GROUP

F28 Stripe

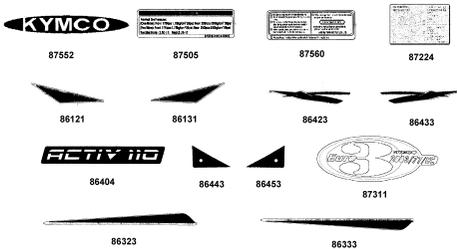

E01

Cylinder skull

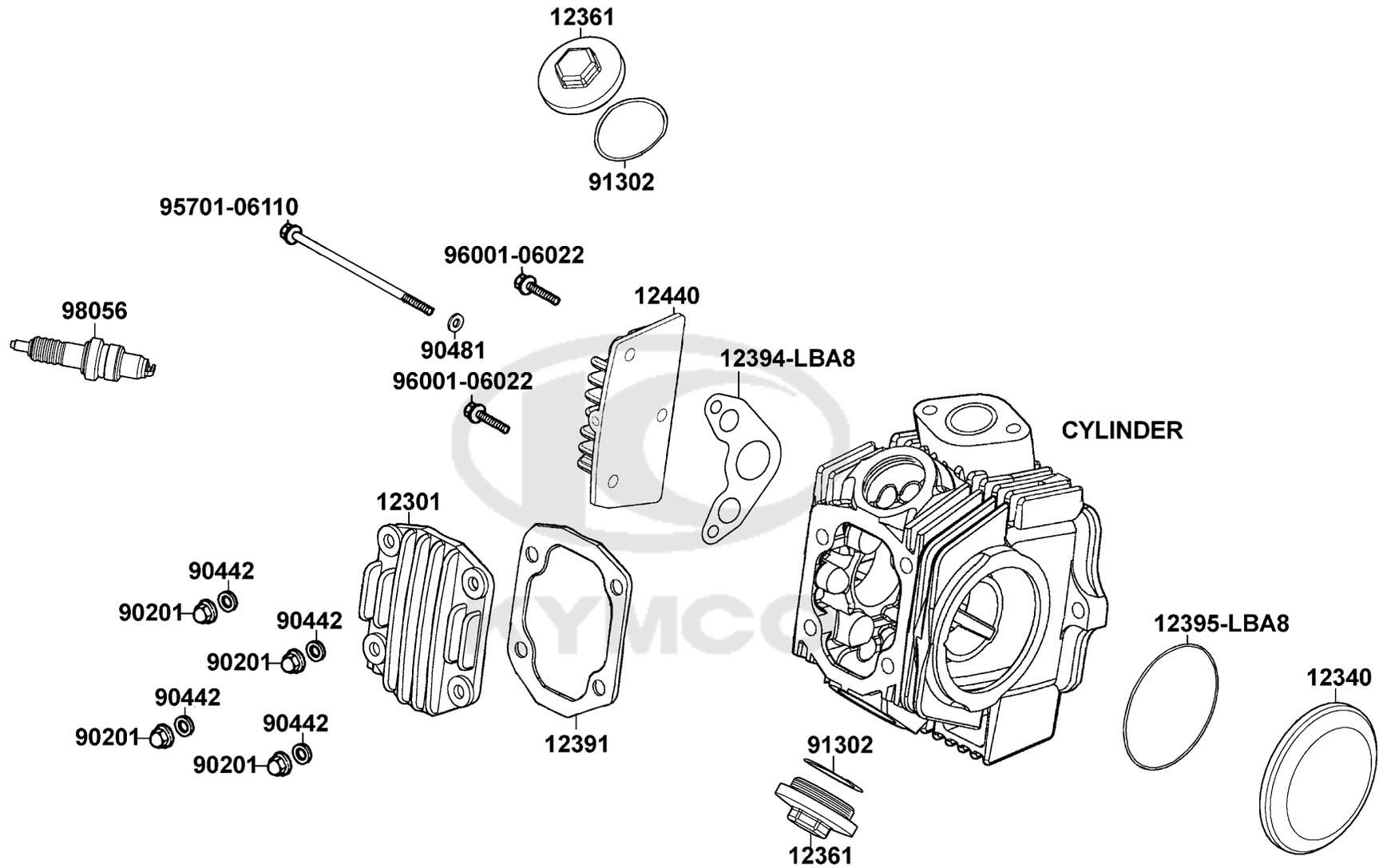

Sales mark	Ref no	Part no	Description	Reg description	Regd no	E01
	12301	12301-LBA8-C000-CK	COVER CYLINDER HEAD	COVER CYLINDER HEAD	1	
	12340	12340-LBA8-E000	COVER CYLN HEAD SIDE L	COVER CYLN HEAD SIDE L	1	
**	12361	12361-0E35-E80	HOLE CAP TAPPET ADJUSTING	HOLE CAP TAPPET ADJUSTING	1	
	12391	12391-LBA8-C10	GASKET HEAD COVER	GASKET HEAD COVER	1	
	12394	12394-LBA8-C10	GASKET CYLN HEAD COVER R	GASKET CYLN HEAD COVER R	1	
	12395	12395-LBA8-C10	GASKET CYLN HEAD COVER L	GASKET CYLN HEAD COVER L	1	
**	12440	12440-LBA8-C10	COVER CYL HEAD SIDE R	COVER CYL HEAD SIDE R	1	
	90201	90201-GFF6-011	NUT CAP 7MM	NUT CAP 7MM	1	
	90442	90442-GFF6-C00	WASHER SEALING 7MM	WASHER SEALING 7MM	1	
	90481	90481-GGS7-C00	WASHER	WASHER 6.5 MM	1	
	91302	91302-KGB4-C11	O-RING 30.8	O-RING 30.8	1	
	95701	95701-06110-08	BOLT FLANGE SH 6*110 (C)	BOLT FLANGE SH 6*110 (C)	1	
	96001	96001-06022-08	BOLT FLANGE SH 6*22	BOLT FLANGE SH 6*22	2	
	98056	98056-5771R-00	SPARK PLUG (CR7HSA)	SPARK PLUG (CR7HSA)	1	

E02

Cylinder Head

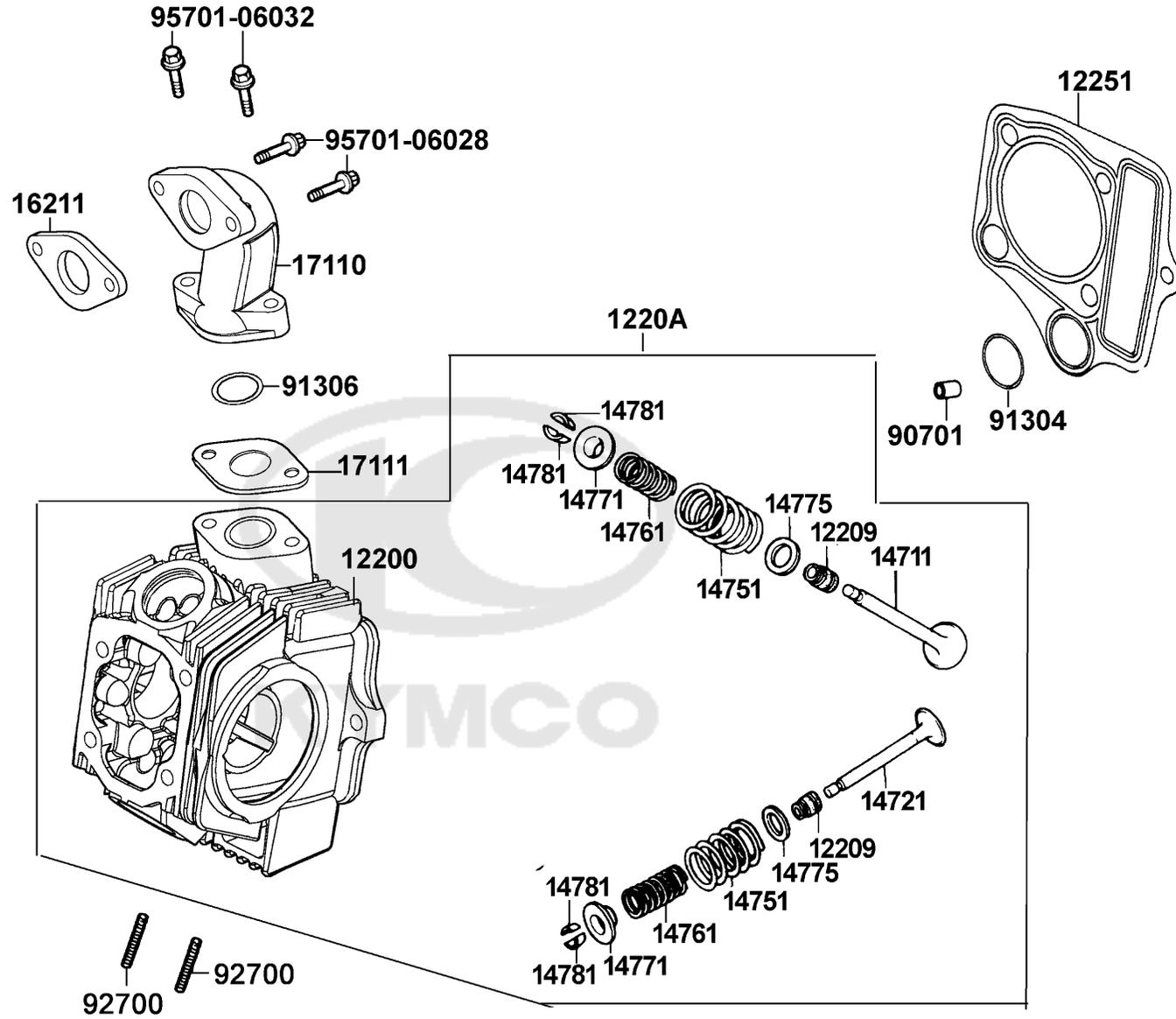

Sales mark	Ref no	Part no	Description	Reg description	Regd no	E02
**	12200	12200-LBA8-C10	HEAD COMP CYLINDER	HEAD COMP CYLINDER	1	
	12209	12209-GDB4-C00	SEAL VALVE STEM	SEAL VALVE STEM	1	
	1220A	1220A-LBA8-C10	HEAD ASSY CYLINDER	HEAD ASSY CYLINDER	1	
	12251	12251-LBA8-C11	GASKET CYLINDER HEAD	GASKET CYLINDER HEAD	1	
	14711	14711-LBA8-C10	VALVE INLET	VALVE INLET	1	
	14721	14721-LBA8-C10	VALVE EXHAUST	VALVE EXHAUST	1	
	14751	14751-LBA8-C10	SPRING VALVE OUTER	SPRING VALVE OUTER	2	
	14761	14761-LBA8-C10	SPRING VALVE INNER	SPRING VALVE INNER	2	
	14771	14771-GDB4-C00	RETAINER VALVE SPRING	RETAINER VALVE SPRING	1	
	14775	14775-MFA6-C00	SEAT VALVE SPG OUTER	SEAT VALVE SPG OUTER	1	
	14781	14781-LBA8-C10	COTTER VALVE	COTTER VALVE	1	
	16211	16211-LBA8-C10	INSULATOR CARB	INSULATOR CARB	1	
	17110	17110-LBA8-E80	PIPE INLET	PIPE INLET	1	
	17111	17111-LBA8-C10	GASKET INLET PIPE	GASKET INLET PIPE	1	
	90082	90082-0E35-C00	BOLT FLANGE 6*23	BOLT FLANGE 6*23	1	
	90701	90701-LBA8-C10	PIN DOWEL SPECIAL 8*10	PIN DOWEL SPECIAL 8*10	1	
	91304	91304-LBA8-C10	RECTANGULAR RING 9*11.7*1.5	RECTANGULAR RING 9*11.7*1.5	1	
	91306	91306-LBA8-C10	O-RING 25*2.4	O-RING 25*2.4	1	
	92700	92700-KGE2-C10	BOLT STUD 6*35 (C)	BOLT STUD 6*35 (C)	2	
	95701-06028	95701-06028-08	BOLT FLANGE 6*28	BOLT FLANGE 6*28 (C)	2	

E02

Cylinder Head

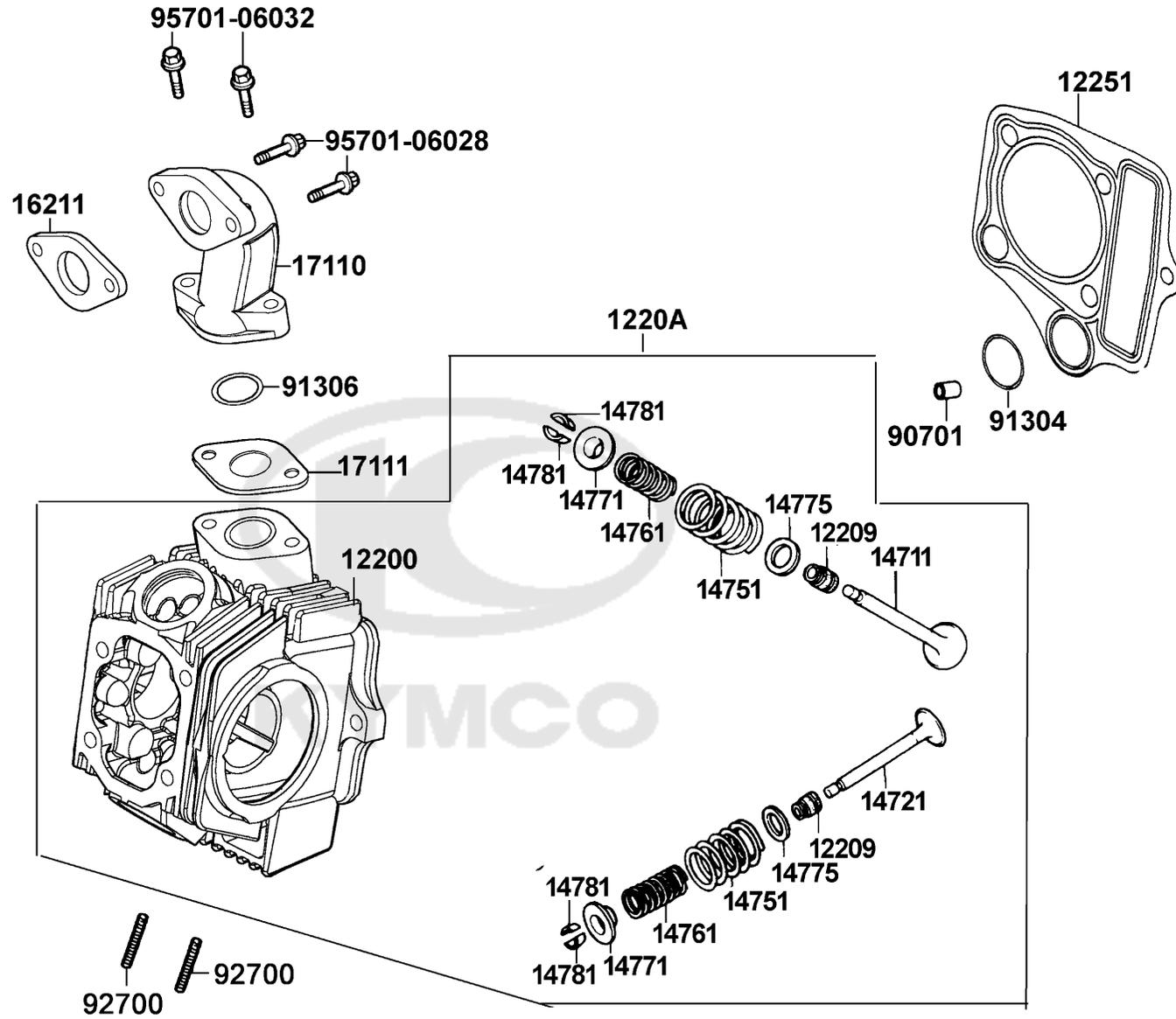

Sales mark	Ref no	Part no	Description	Reg description	Regd no	E02
------------	--------	---------	-------------	-----------------	---------	------------

95701-06032

95701-06032-08

BOLT FLANGE 6*32

BOLT FLANGE 6*32

2



E03

Cam shaft

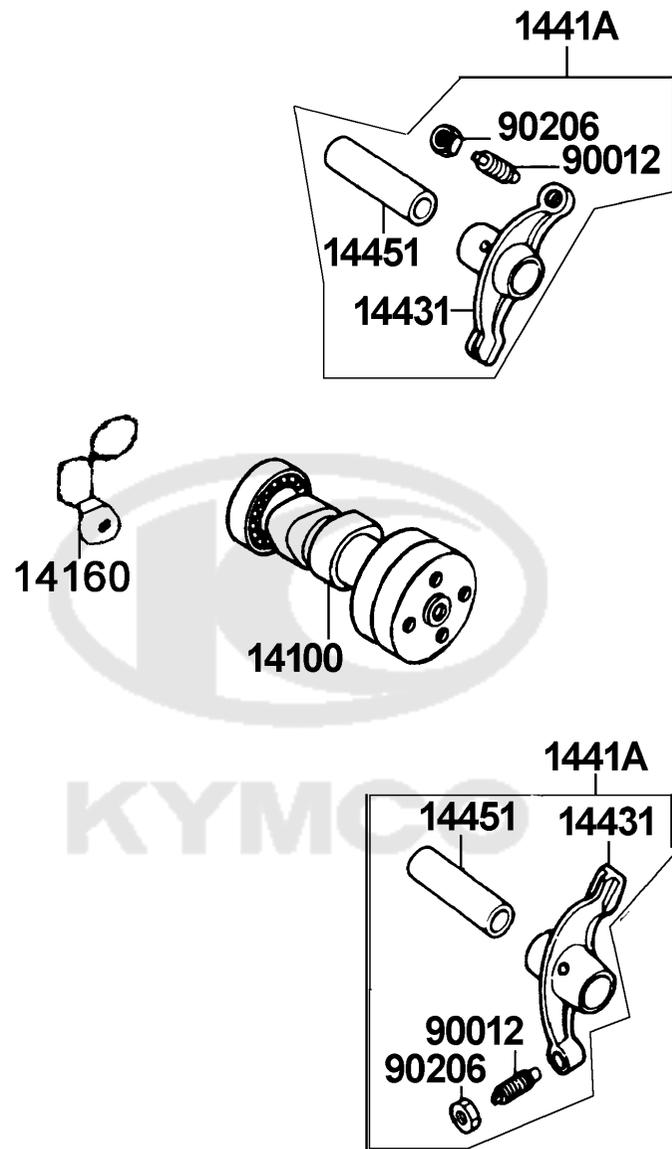

Sales mark	Ref no	Part no	Description	Reg description	Regd no	E03
14100		14100-LBA8-C10	SHAFT COMP CAM	SHAFT COMP CAM	1	
14160		14160-LBA8-C10	CAGING PLATE COMP	CAGING PLATE COMP	1	
1441A		1441A-LBA8-C10	ROCKER ARM ASSEMBLY	ROCKER ARM ASSEMBLY	1	
14431		14431-LBA8-C10	ARM VALVE ROCKER	ARM VALVE ROCKER	1	
14451		14451-LBA8-C10	SHAFT ROCKER ARM	SHAFT ROCKER ARM	1	
90012		90012-3C33-C00	SCREW TAPPET ADJUSTING	SCREW TAPPET ADJUSTING	1	
90206		90206-0A01-001	NUT TAPPET ADJG	NUT TAPPET ADJG	1	



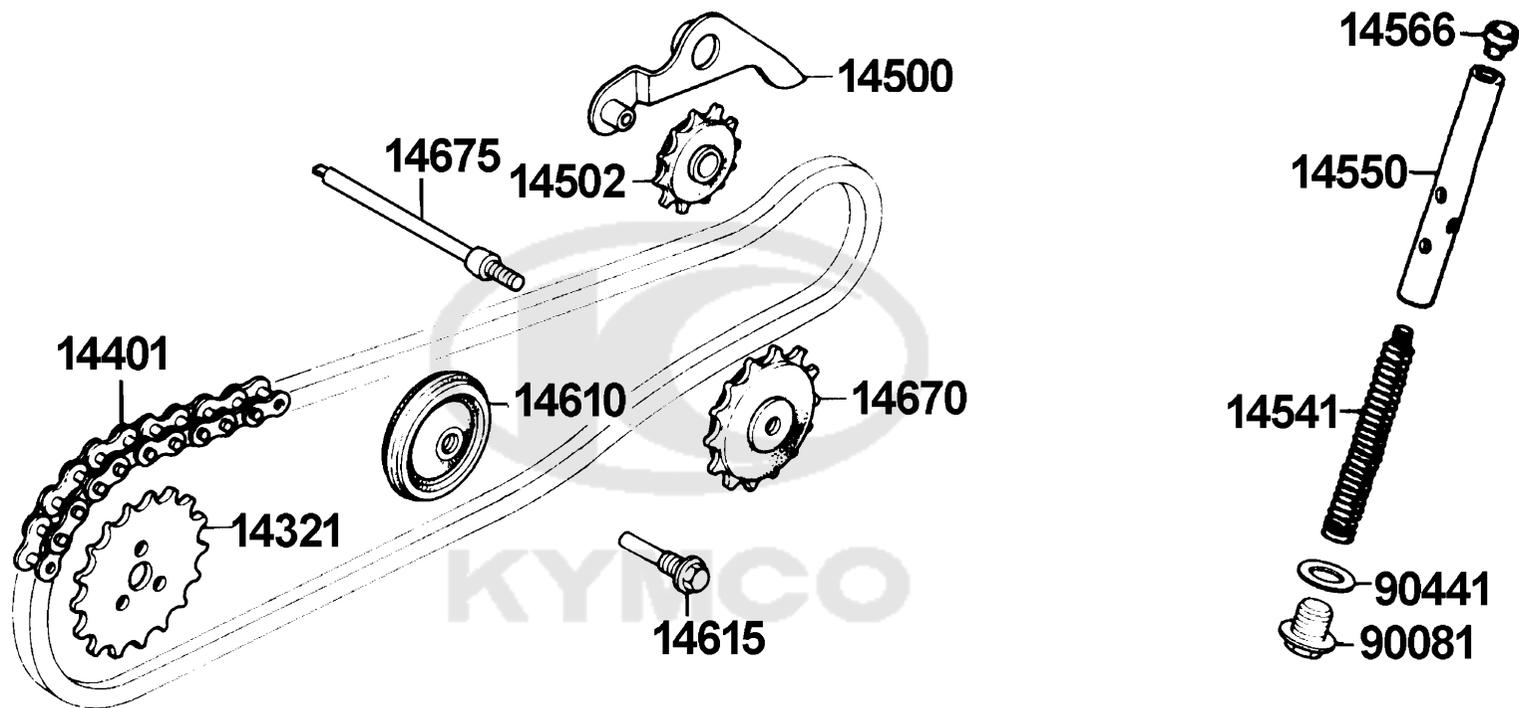

Sales mark	Ref no	Part no	Description	Reg description	Regd no	E04
14321		14321-LBA8-C10	SPROCKET CAM 28T	SPROCKET CAM 28T	1	
14401		14401-LBA8-C10	CHAIN CAM 84	CHAIN CAM 84	1	
14500		14500-LBA8-C10	ARM COMP CAM CHAIN TENSIONER	ARM COMP CAM CHAIN TENSIONER	1	
14502		14502-0F86-C00	ROLLER CAM CHAIN TENSIONER	ROLLER CAM CHAIN TENSIONER	1	
14541		14541-LBA8-C10	SPRING TENSIONER	SPRING TENSIONER	1	
14550		14550-LBA8-C10	PUSH ROD COMP TENSIONER	PUSH ROD COMP TENSIONER	1	
14566		14566-LBA8-C10	HEAD TENSIONER PUSH ROD	HEAD TENSIONER PUSH ROD	1	
14610		14610-KGC4-C00	ROLLER COMP CAM CHAIN	ROLLER COMP CAM CHAIN	1	
14615		14615-LBA8-C10	PIN GUIDE ROLLER	PIN GUIDE ROLLER	1	
14670		14670-KGB4-C10	SPROCKET CAM CHAIN GUIDE	SPROCKET CAM CHAIN GUIDE	1	
14675		14675-LBA8-C10	SPRING CAM CHAIN GUIDE SPROCK	SPRING CAM CHAIN GUIDE SPROCK	1	
90081		90081-0E35-C00	14MM SEALING BOLT	14MM SEALING BOLT	1	
90441		90441-0E35-C00	CYLINDER WASHER	CYLINDER WASHER	1	

E05

Cylinder

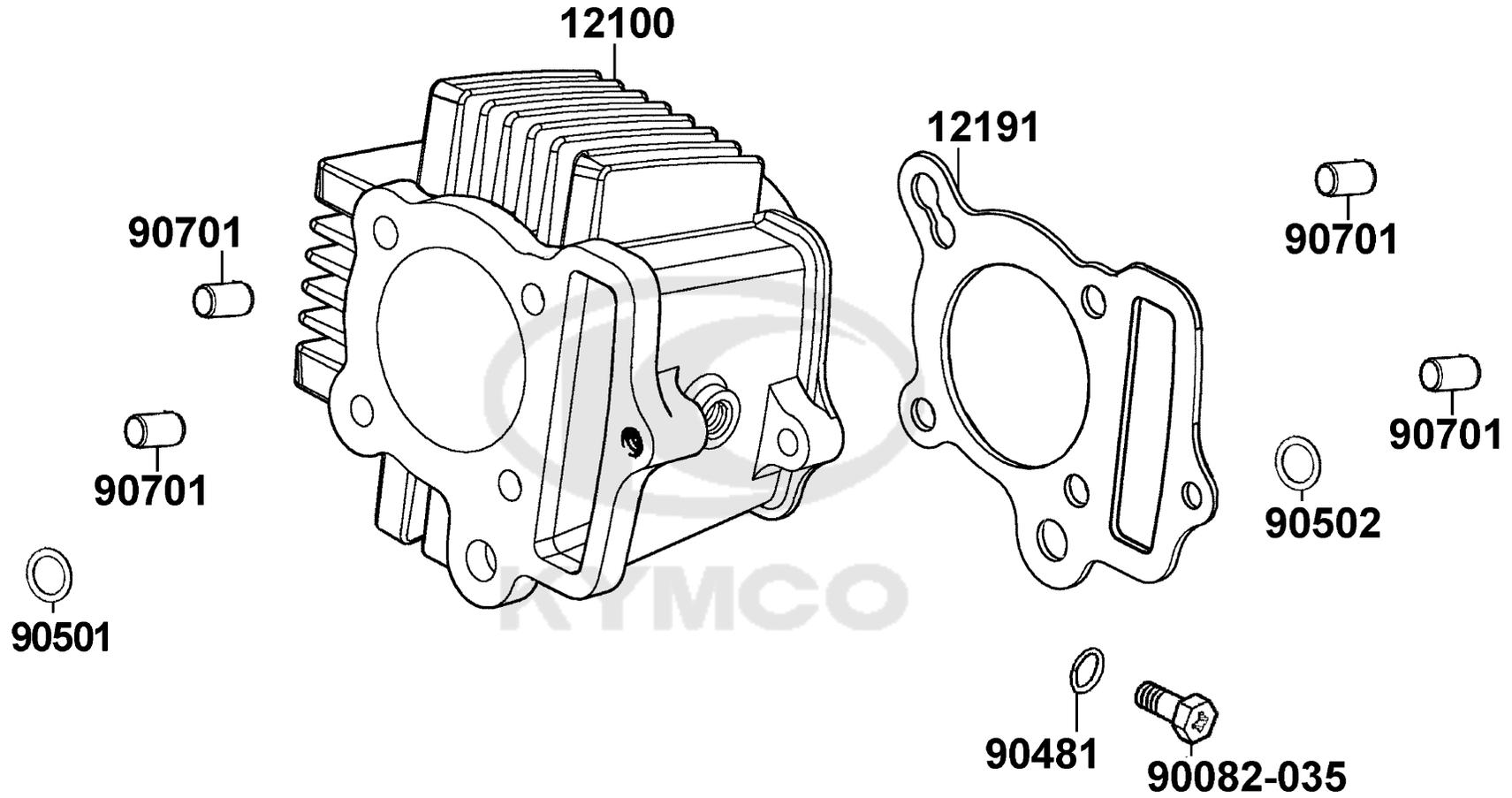

Sales mark	Ref no	Part no	Description	Reg description	Regd no	E05
	12100	12100-LBA8-C000	CYLINDER COMP	CYLINDER COMP	1	
	12191	12191-LBA8-C10	GASKET CYLINDER	GASKET CYLINDER	1	
	90082	90082-0E35-C00	BOLT FLANGE 6*23	BOLT FLANGE 6*23	1	
	90481	90481-LBA8-C10	WASHER 11.2X15X2.0	WASHER 11.2X15X2.0	1	
	90501	90501-LBA8-C10	RECTANGULAR RING 14.5*18.5*2.4	RECTANGULAR RING 14.5*18.5*2.4	1	
	90502	90502-LBA8-C10	RECTANGULAR RING 11.5*15.7*2.4	RECTANGULAR RING 11.5*15.7*2.4	1	
	90701	90701-GFF6-C00	PIN DOWEL SPECIAL 8*14	PIN DOWEL SPECIAL 8*14	1	
						

E06

Crankcase Right Cover

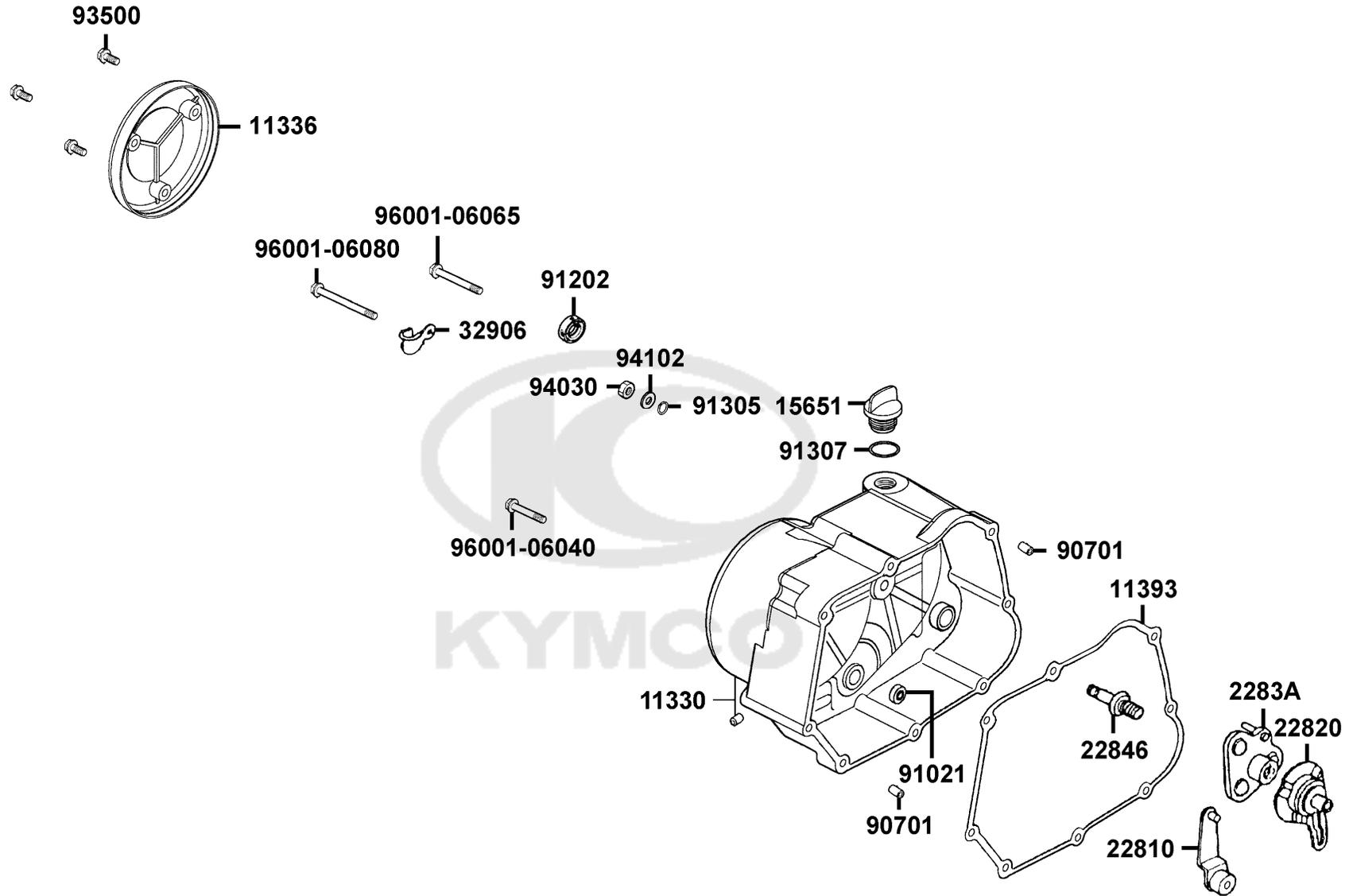

Sales mark	Ref no	Part no	Description	Reg description	Regd no	E06
**	11330	11330-LBA8-C10	COVER COMP R CRANK CASE	COVER COMP R CRANK CASE	1	
**	11336	11336-LBA8-C10	COVER R MARK	COVER R MARK	1	
	11393	11393-LBA8-C10	GASKET R CRANK CASE COVER	GASKET R CRANK CASE COVER	1	
	15651	15651-LBA8-C10	GUAGE OIL LEVEL	GUAGE OIL LEVEL	1	
	22810	22810-LBA8-C10	CLUTCH LEVEL COMP	CLUTCH LEVEL COMP	2	
	22820	22820-LBA8-C10	CLUTCH LIFT COMP	CLUTCH LIFT COMP	1	
	2283A	2283A-LBA8-C10	CLUTCH LIFTER BOSS ASSY	CLUTCH LIFTER BOSS ASSY	1	
	22846	22846-LBA8-C10	CLUTCH ADJUSTING BOLT	CLUTCH ADJUSTING BOLT	1	
	32906	32906-LBA8-C10	WIRE CLAMP (C)	WIRE CLAMP (C)	1	
	90701	90701-HDC4-C00	DOWEL PIN 8*12	DOWEL PIN 8*12	1	
	91021	91021-1H48-C00	BRG BALL RADIAL10*10	BRG BALL RADIAL10*10	1	
	91202	91202-KGB4-C10	OIL SEAL 13.7*24*5	OIL SEAL 13.7*24*5	1	
	91305	91305-LBA8-C10	O-RING 7.8*1.9	O-RING 7.8*1.9	1	
	91307	91307-0E35-W10	O-RING 18*3	O-RING 18*3	1	
	93500	93500-06012-00	SCREW PAN M6*12	SCREW PAN M6*12	3	
	94030	94030-08080-0S	NUT HEX 8MM (C)	NUT HEX 8MM (C)	1	
	94102	94102-08800	WASHER PLAIN 8MM	WASHER PLAIN 8MM	1	
	96001-06040	96001-06040-08	BOLT FLANGE 6*40	BOLT FLANGE 6*40	5	
	96001-06065	96001-06065-08	BOLT FLANGE 6*65	BOLT FLANGE 6*65	1	
	96001-06080	96001-06080-08	BOLT FLANGE SH 6*80	BOLT FLANGE SH 6*80(C)	2	

E07

Automatic clutch

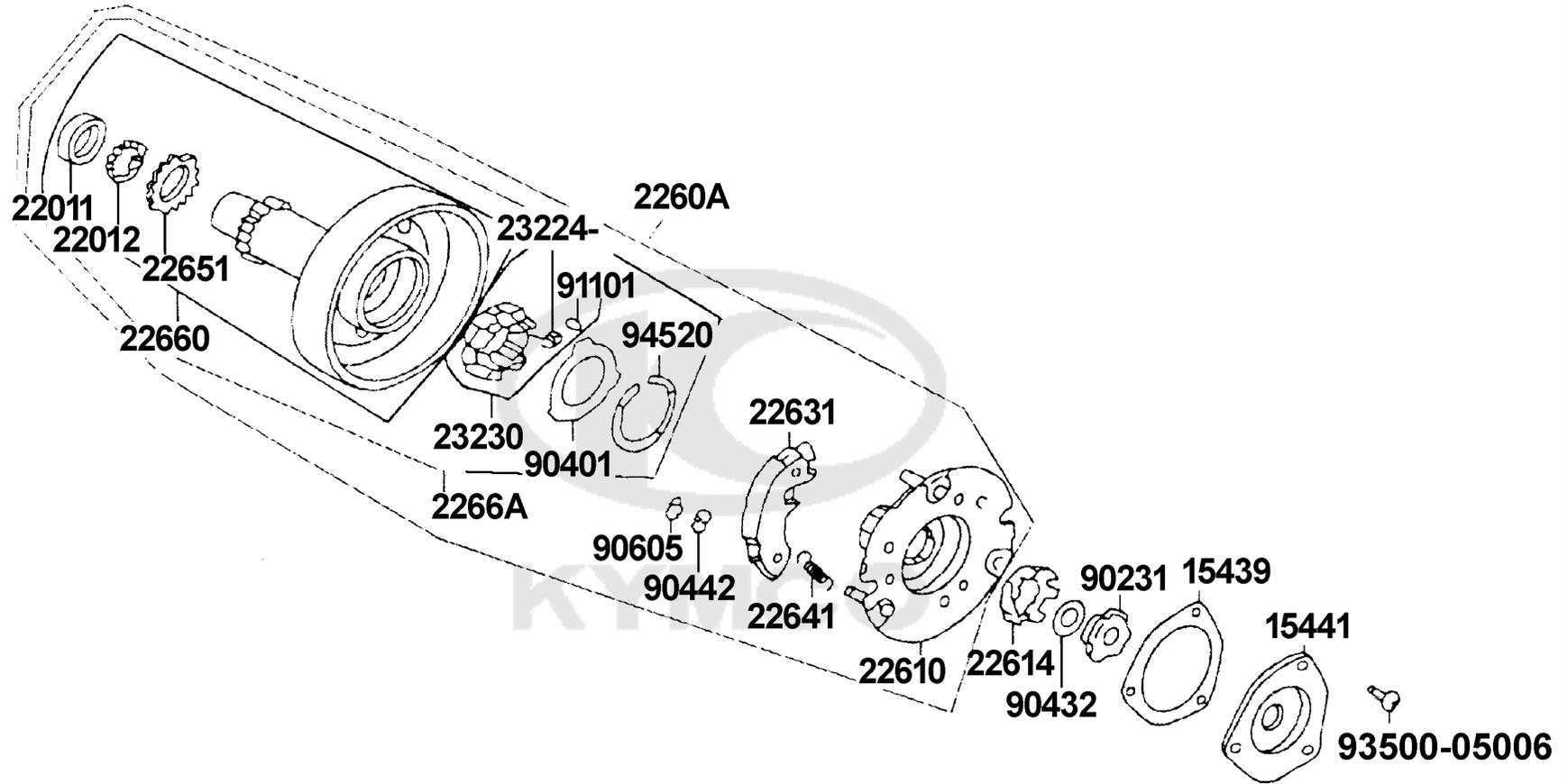

Sales mark	Ref no	Part no	Description	Reg description	Regd no	E07
	15439	15439-LBA8-C11	GASKET ROTOR OIL FILTER	GASKET ROTOR OIL FILTER	1	
	15441	15441-LBA8-C10	COVER ROTOR OIL FILTER	COVER ROTOR OIL FILTER	1	
	22011	22011-LBA8-C10	SLEEVE GEAR	SLEEVE GEAR	1	
	22012	22012-LBA8-C10	SPRING SIDE GEAR(17T)	SPRING SIDE GEAR(17T)	1	
	2260A	2260A-LBA8-C10	PRIMARY CLUTCH ASSY	PRIMARY CLUTCH ASSY	1	
	22610	22610-LBA8-C10	PRIMARY DRIVE PLATE	PRIMARY DRIVE PLATE	1	
	22614	22614-LBA8-C10	WASHER FIXED	WASHER FIXED	1	
	22631	22631-LBA8-C10	PRIMARY CLUTCH WEIGHT	PRIMARY CLUTCH WEIGHT	1	
	22641	22641-LBA8-C10	PRIMARY CLUTCH SPRING	PRIMARY CLUTCH SPRING	1	
	22651	22651-LBA8-C10	SIDE GEAR(17T)	SIDE GEAR(17T)	1	
	22660	22660-LBA8-C10	PRIMARY DRIVE GEAR COMP	PRIMARY DRIVE GEAR COMP	1	
	2266A	2266A-LBA8-C10	PRIMARY DRIVE GEAR ASSY	PRIMARY DRIVE GEAR ASSY	1	
	23224	23224-LBA8-C10	SPRING 150 ONE-WAY CLUTCH	SPRING 150 ONE-WAY CLUTCH	1	
	23230	23230-LBA8-C10	INNER COMP ONE-WAY CLUTCH	INNER COMP ONE-WAY CLUTCH	1	
	90231	90231-GKT9-C00	NUT LICK B 14MM	NUT LOCK B 14MM	1	
	90401	90401-LBA8-C10	WASHER 17.4MM	WASHER 17.4MM	1	
	90432	90432-0F86-C00	WASHER LOCK B	WASHER LOCK B	1	
	90442	90442-LBA8-C10	THRUST WASHER 9MM	THRUST WASHER 9MM	1	
	90605	90605-1F66-C00	CIR CLIP 7MM	CIR CLIP 7MM	1	
	91101	91101-LBA8-C10	ROLLER 8*8	ROLLER 8*8	1	

E07

Automatic clutch

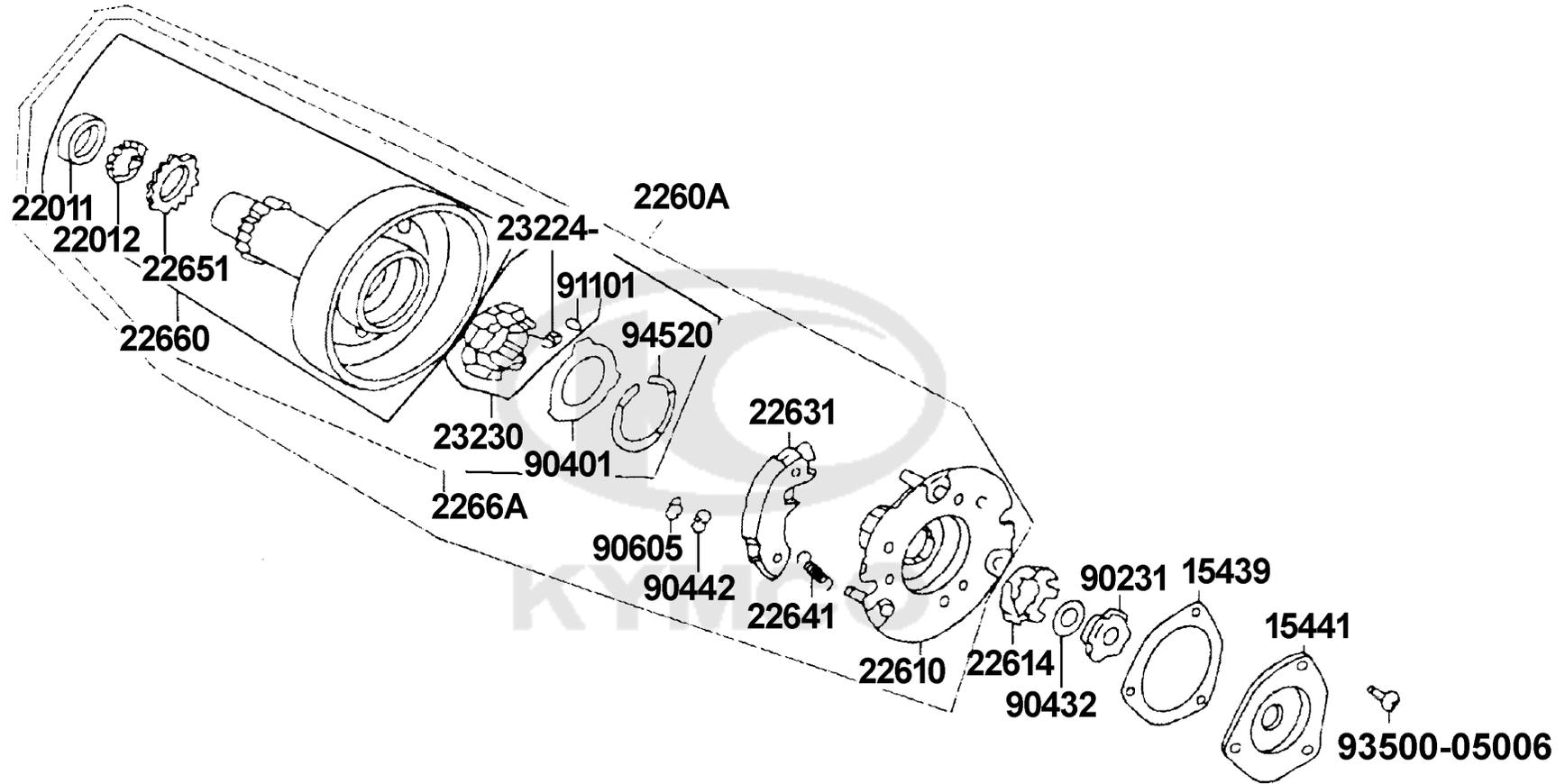

Sales mark	Ref no	Part no	Description	Reg description	Regd no	E07
------------	--------	---------	-------------	-----------------	---------	------------

93500	93500-05006-00	93500-05006-00	BOLT FLANGE SH 5*6 (C)	BOLT FLANGE SH 5*6 (C)	3	
94520	94520-42000	94520-42000	CIR CLIP IN 42MM	CIR CLIP IN 42	1	



E08

clutch

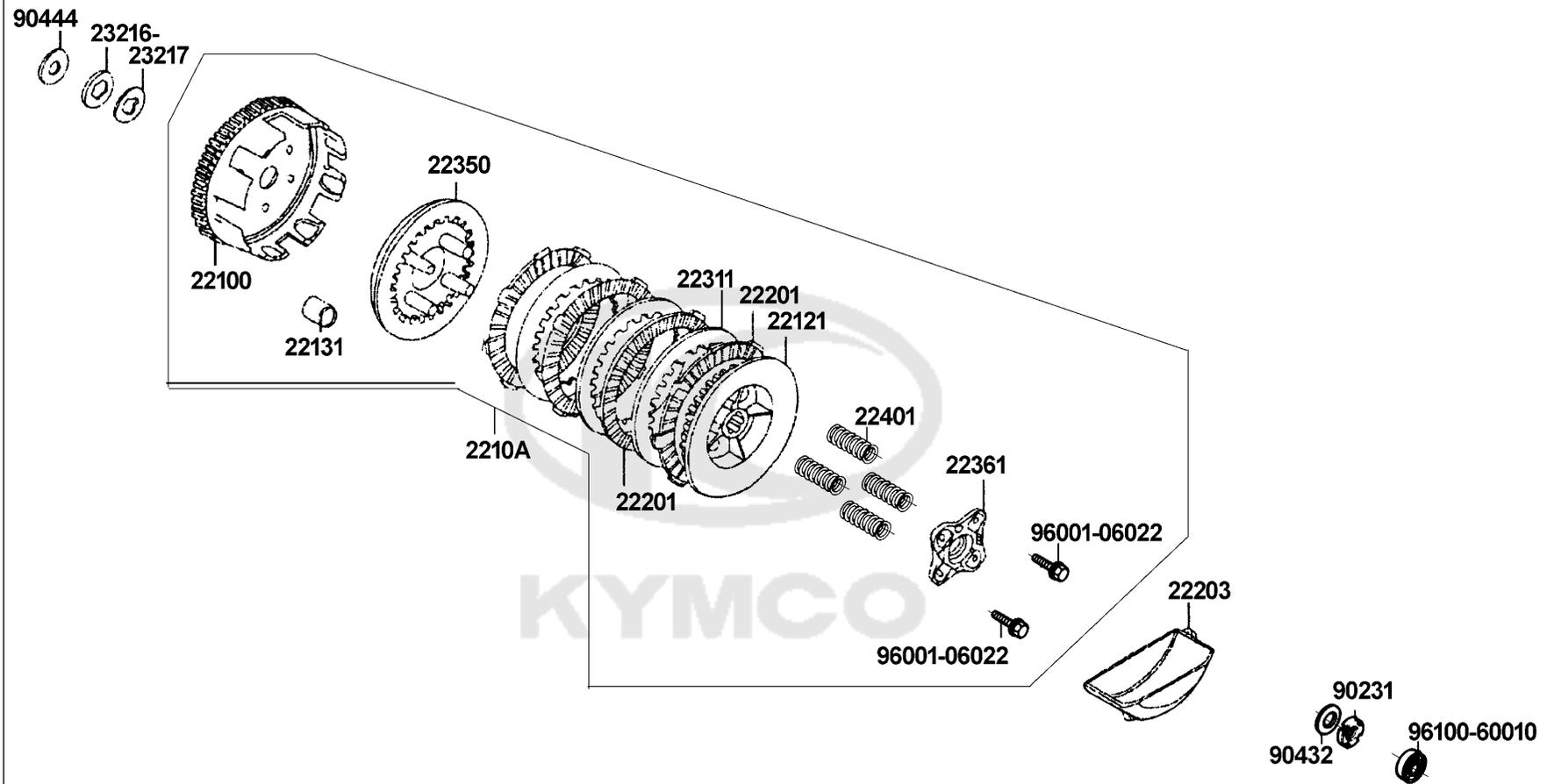

Sales mark	Ref no	Part no	Description	Reg description	Regd no	E08
22100		22100-LBA8-C10	OUTER COMP CLUTCH	OUTER COMP CLUTCH	1	
2210A		2210A-LBA8-C10	CLUTCH ASSY	CLUTCH ASSY	1	
22121		22121-LBA8-C10	CENTER CLUTCH	CENTER CLUTCH	1	
22131		22131-LBA8-C10	GUIDE CLUTCH OUTER	GUIDE CLUTCH OUTER	1	
22201		22201-LBA8-C10	DISK CLUTCH FRICTION	DISK CLUTCH FRICTION	1	
22203		22203-LBA8-C10	OIL-SEPARATING COVER	OIL-SEPARATING COVER	1	
22311		22311-1G07-C00	PLALTE CLUTCH	PLALTE CLUTCH	1	
22350		22350-LBA8-C10	PLATE CLUTCH PRESSURE	PLATE CLUTCH PRESSURE	1	
22361		22361-LBA8-C10	PLATE CLUTCH LIFTER	PLATE CLUTCH LIFTER	1	
22401		22401-LBA8-C10	SPRING CLUTCH	SPRING CLUTCH	1	
23216		23216-LBA8-C10	WASHER SPLINE 17MM	WASHER SPLINE 17MM	1	
23217		23217-LBA8-C10	WASHER FIXED	WASHER FIXED	1	
90231		90231-0G87-C00	NUT LOCK 14MM	NUT LOCK 14MM	1	
90432		90432-0F86-C00	WASHER LOCK B	WASHER LOCK B	1	
90444		90444-LBA8-C10	WASHER SPECIAL	WASHER SPECIAL	1	
96001		96001-06022-08	BOLT FLANGE SH 6*22	BOLT FLANGE SH 6*22	4	
96100		96100-60000-00	BEARING BALL RADIAL 6000	BEARING BALL RADIAL 6000	1	

E09

Oil pump

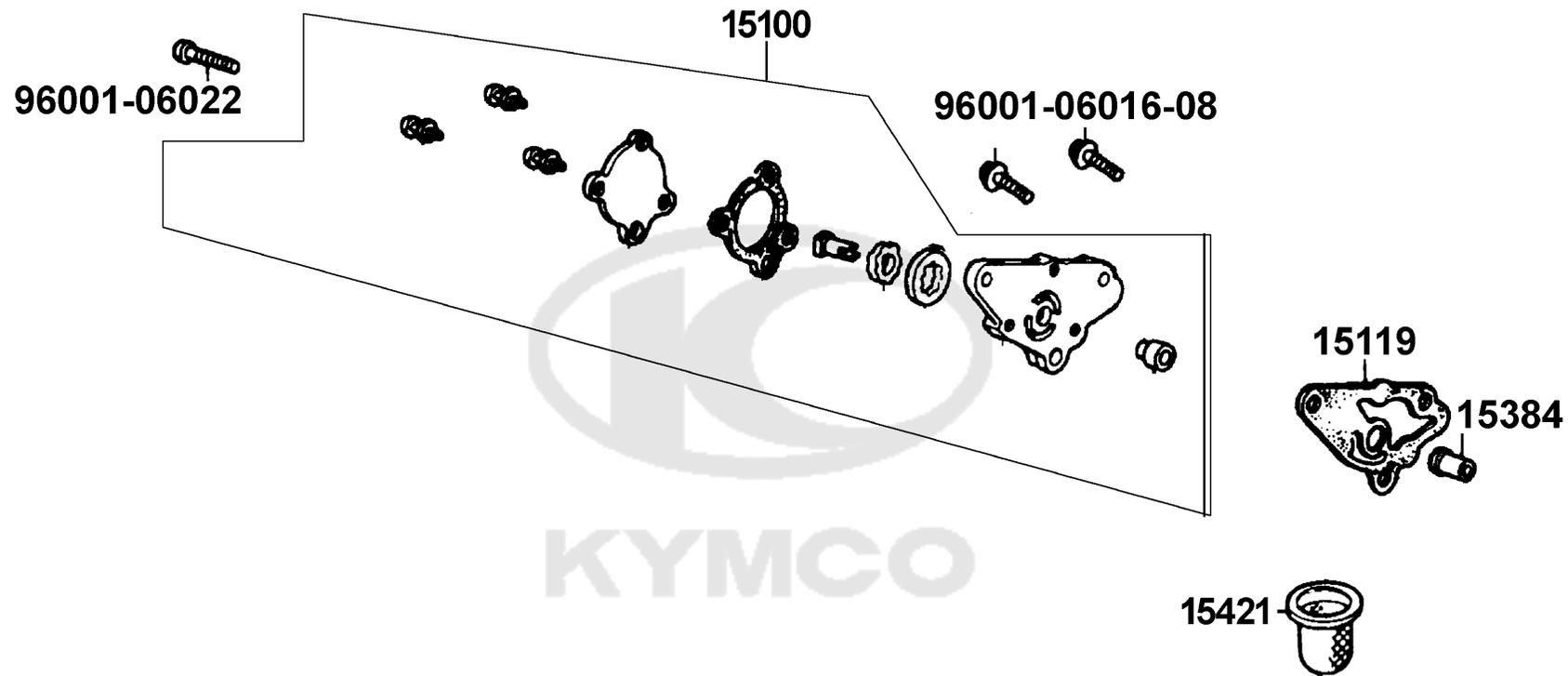

Sales mark	Ref no	Part no	Description	Reg description	Regd no	E09
	15100	15100-LBA8-C10	OIL PUMP ASSY	OIL PUMP ASSY	1	
	15119	15119-LBA8-C10	OIL PUMP BODY GASKET	OIL PUMP BODY GASKET	1	
	15384	15384-LBA8-C10	PIVOT OIL PUMP	PIVOT OIL PUMP	1	
	15421	15421-LBA8-C10	SCREEN OIL FILTER	SCREEN OIL FILTER	1	
	96001-06016	96001-06016-08	BOLT FLANGE SH 6*16	BOLT FLANGE SH 6*16	2	
	96001-06022	96001-06022-08	BOLT FLANGE SH 6*22	BOLT FLANGE SH 6*22	1	



E10

Crankcase left Cover

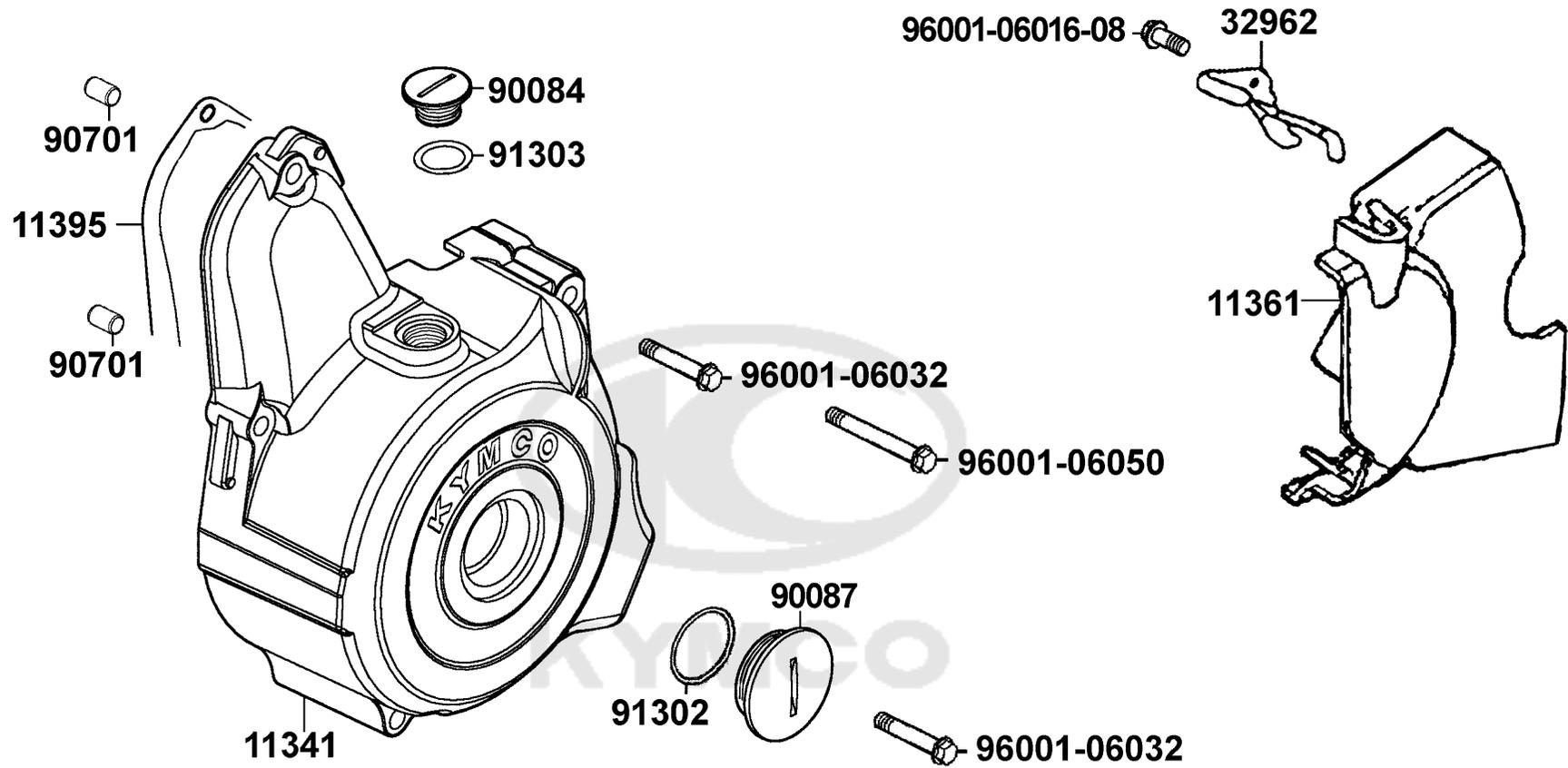

Sales mark	Ref no	Part no	Description	Reg description	Regd no	E10
	11341	11341-LBA8-C10	COVER COMP L SIDE	COVER COMP L SIDE	1	
	11361	11361-LBA8-C000	COVER LEFT REAR CRANK	COVER LEFT REAR CRANK	1	
	11395	11395-LBA8-C10	GASKET L COVER	GASKET L COVER	1	
	32962	32962-LBA8-C10	CLAMPER PULSER CORD (C	CLAMPER PULSER CORD (C	1	
**	90084	90084-LBA8-E80	CAP ACG	CAP ACG	1	
**	90087	90087-4H28-E80	CAP 30MM	CAP 30MM	1	
	90701	90701-HDC4-C00	DOWEL PIN 8*12	DOWEL PIN 8*12	1	
	91302	91302-5G67-C00	O-RING 27.4*2.4	O-RING 27.4*2.4	1	
	91303	91303-3G77-C00	O-RING 13.8*2.5	O-RING 13.8*2.5	1	
	96001-06016	96001-06016-08	BOLT FLANGE SH 6*16	BOLT FLANGE SH 6*16	1	
	96001-06032	96001-06032-08	BOLT FLANGE SH 6*32	BOLT FLANGE SH 6*32	2	
	96001-06050	96001-06050-08	BOLT FLANGE 6*50	BOLT FLANGE SH 6*50 (C)	1	

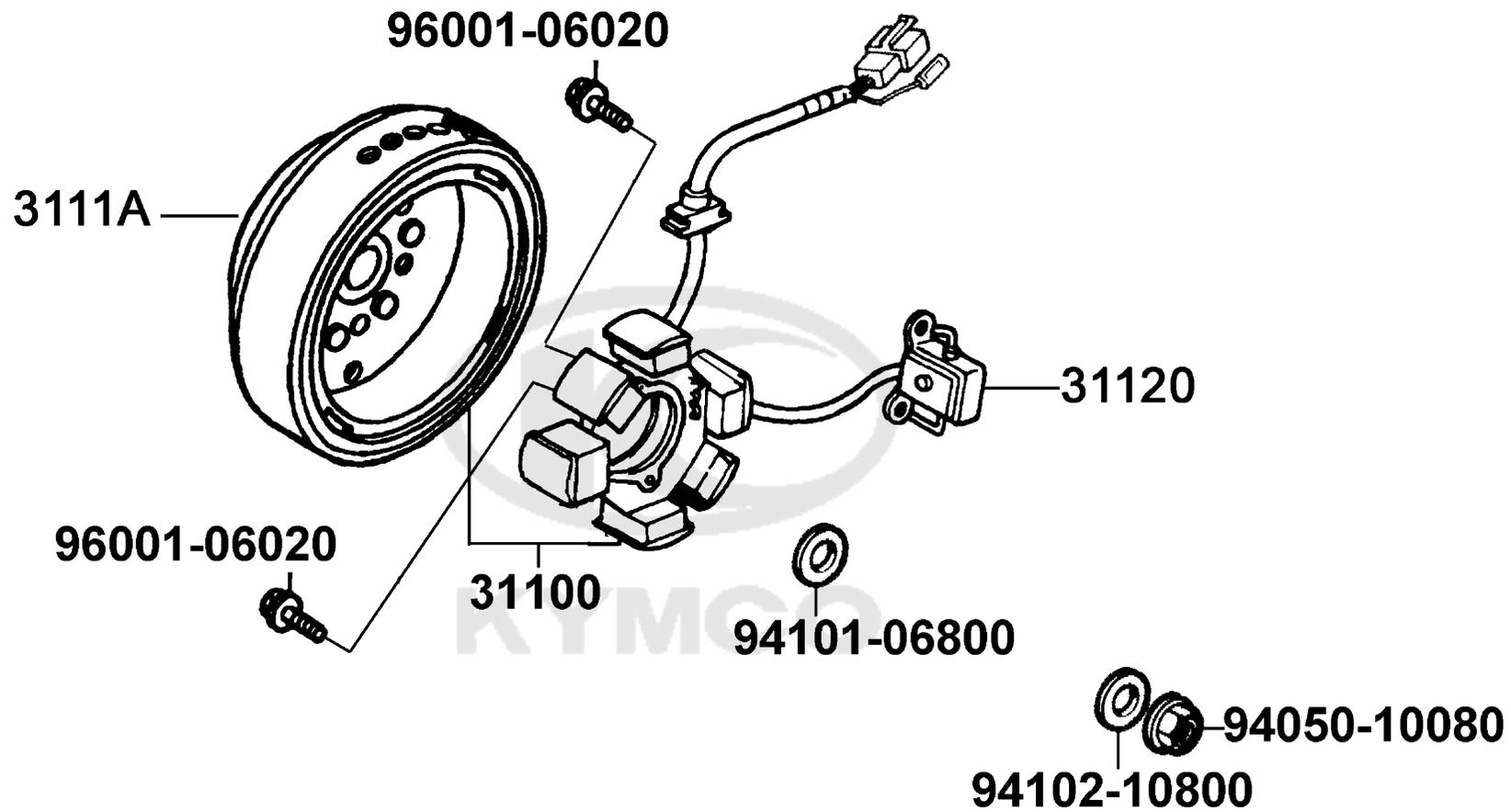

Sales mark	Ref no	Part no	Description	Reg description	Regd no	E11
	31100	31100-LBA8-E000	ACG ONE WAY COMP	ACG ONE WAY COMP	1	
	3111A	3111A-LBA8-C10	FLYWHEEL COMP	FLYWHEEL COMP	1	
	31120	31120-LBA8-E80	STATOR COMP	STATOR COMP	1	
	94050	94050-10080	NUT FLANGE 10MM	NUT FLANGE 10MM (C)	1	
	94101	94101-06800	WASHER PLAIN 6MM	WASHER PLAIN 6MM (C)	1	
	94102	94102-10800	WASHER PLAIN 10MM	WASHER PLAIN 10MM (C)	1	
	96001	96001-06020-08	BOLT FLANGE SH 6*20	BOLT FLANGE SH 6*20	2	



E12

Coupling coat

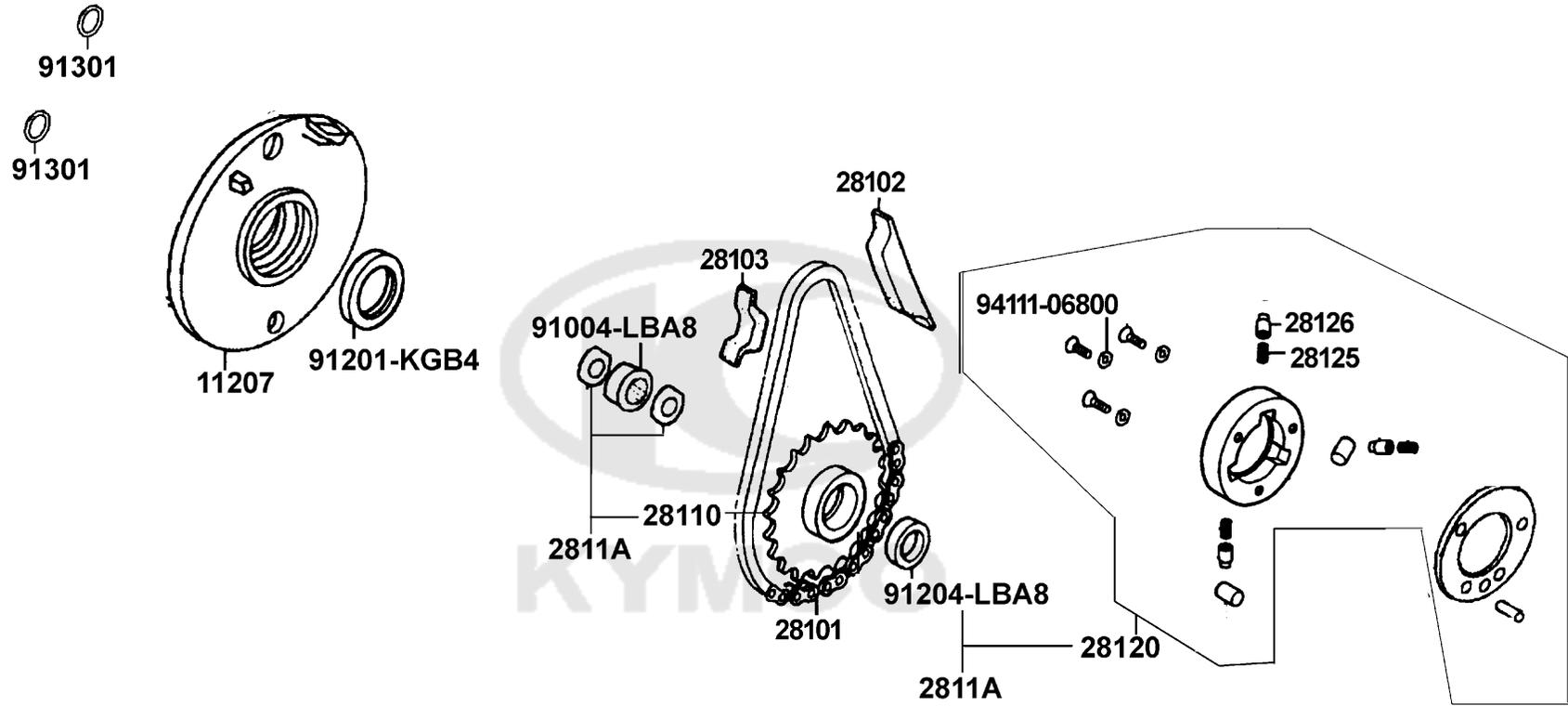

Sales mark	Ref no	Part no	Description	Reg description	Regd no	E12
11207		11207-LBA8-C10	PLATE CRANK CASE L	PLATE CRANK CASE L	1	
28101		28101-LBA8-C10	CHAIN STARTER	CHAIN STARTER	1	
28102		28102-LBA8-C10	GUIDE STARTER CHAIN	GUIDE STARTER CHAIN	1	
28103		28103-KGB4-C10	PROTECTOR STARTER CHAIN(GD-	PROTECTOR STARTER CHAIN(GD-M001C)	1	
28110		28110-LBA8-C10	STARTER SPROCKET	STARTER SPROCKET	1	
2811A		2811A-LBA8-C10	STARTER SPROCKET COMP	STARTER SPROCKET COMP	1	
28120		28120-LBA8-C10	OUTER COMP CLUTCH	OUTER COMP CLUTCH	1	
28125		28125-3C23-C00	SPRING ROLLER STARTER CLUTCH	SPRING ROLLER STARTER CLUTCH	1	
28126		28126-LBA8-C10	CAP STARTING ROLLER SPRING	CAP STARTING ROLLER SPRING	1	
91004		91004-LBA8-C10	NEEDLE BEARING	NEEDLE BEARING	1	
91201		91201-KGB4-C10	OIL SEAL 30*42*4.5	OIL SEAL 30*42*4.5	1	
91204		91204-LBA8-C10	OIL SEAL 18.9*30*5	OIL SEAL 18.9*30*5	1	
91301		91301-0G27-C00	O-RING 6.8*1.9	O-RING 6.8*1.9	1	
94111		94111-06800	WASHER SPG 6MM	WASHER SPG 6MM	3	

E13

Starting Motor

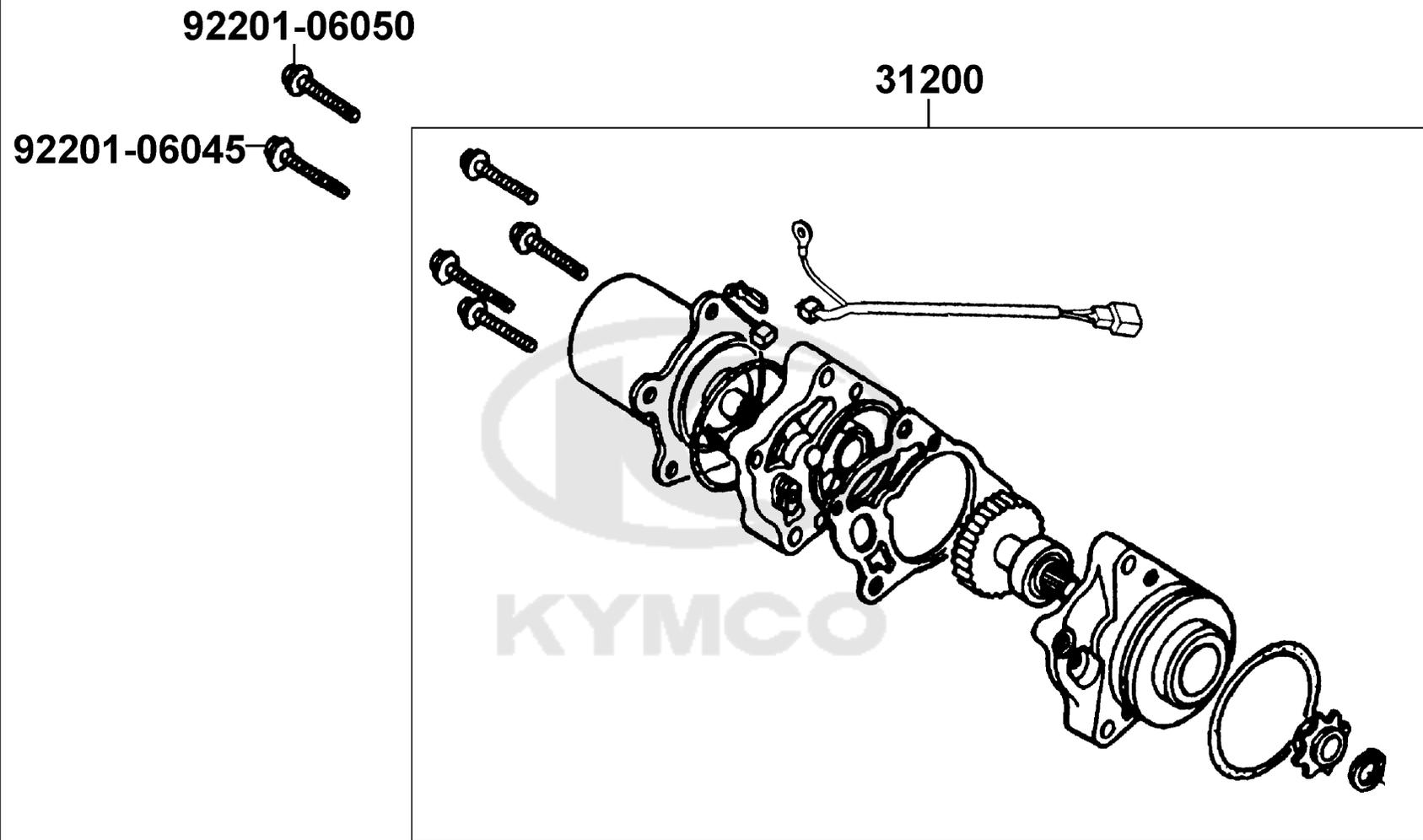

Sales mark	Ref no	Part no	Description	Reg description	Regd no	E13
------------	--------	---------	-------------	-----------------	---------	------------

31200		31200-LBA8-C10	MOTOR ASSY START	MOTOR ASSY START	1	
92201-06045		92201-06045-08	BOLT M6*45(C)	BOLT M6*45(C)	1	
92201-06050		92201-06050-08	BOLT M6*50(C)	BOLT M6*50(C)	1	



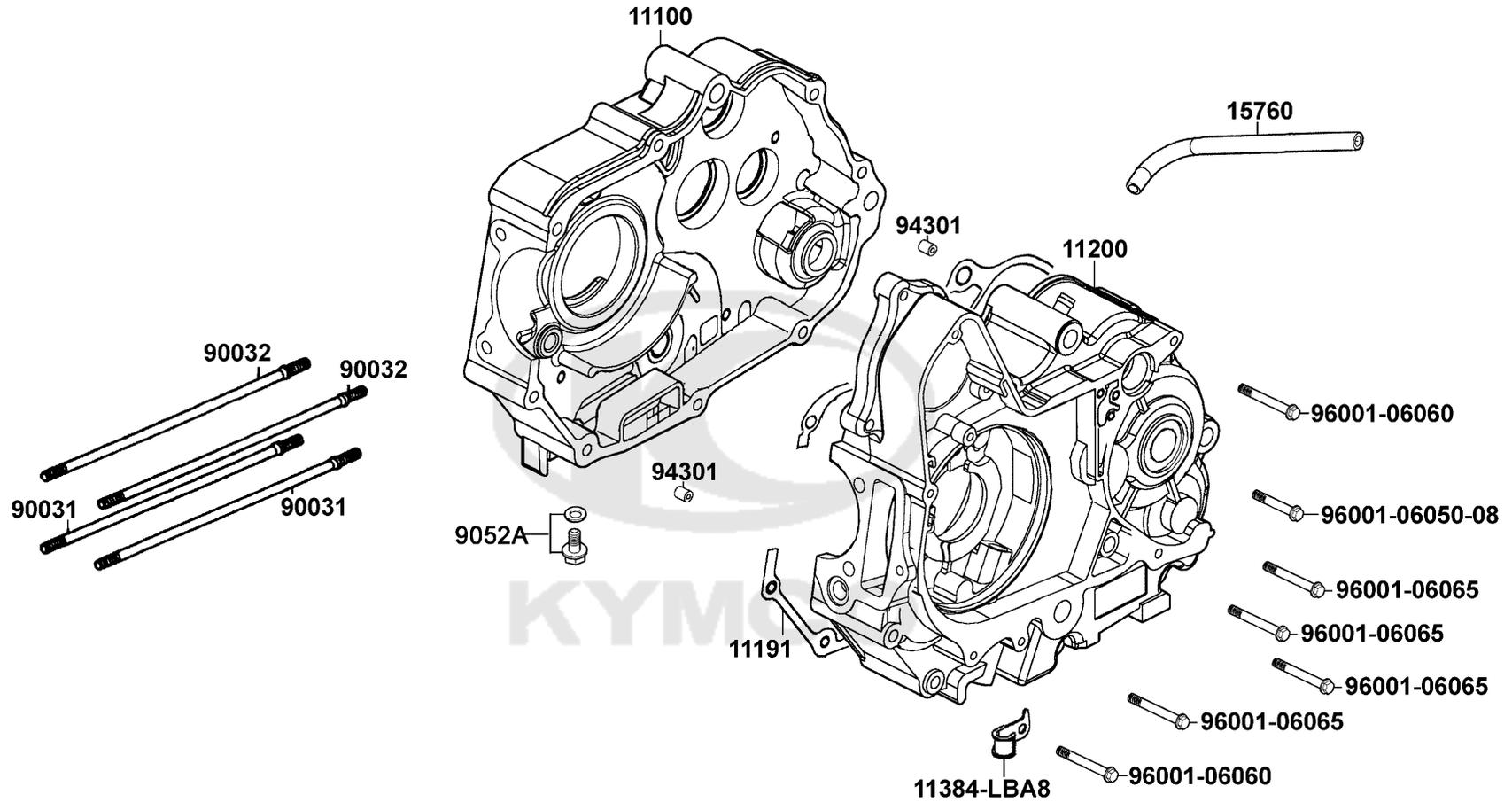

Sales mark	Ref no	Part no	Description	Reg description	Regd no	E14
**	11100	11100-LBA8-C10	CRANK CASE COMP RIGHT	CRANK CASE COMP RIGHT	1	
	11191	11191-LBA8-C10	GASKET CRANK CASE	GASKET CRANK CASE	1	
	11200	11200-LBA8-C000	CRANK CASE COMP LEFT	CRANK CASE COMP LEFT	1	
	11384	11384-LBA8-C10	CLAMP TUBE	CLAMP TUBE	1	
	15760	15760-LBA8-C10	TUBE AIR/C	TUBE AIR/C	1	
	90031	90031-LBA8-C10	BOLT A STUD 7*204*6	BOLT A STUD 7*204*6	1	
	90032	90032-LBA8-C10	BOLT B STUD 7*196*6	BOLT B STUD 7*196*6	1	
	9052A	9052A-KGB4-C10	BOLT ASSY DRAIN PLUG	BOLT ASSY DRAIN PLUG	1	
	94301	94301-10140	DOWEL PIN 10*14	PIN A DOWEL 10*14	2	
	96001-06050	96001-06050-08	BOLT FLANGE 6*50	BOLT FLANGE SH 6*50 (C)	1	
	96001-06060	96001-06060-08	BOLT FLANGE SH 6*60	BOLT FLANGE SH 6*60	2	
	96001-06065	96001-06065-08	BOLT FLANGE 6*65	BOLT FLANGE 6*65	4	

E15

Crankshaft Piston

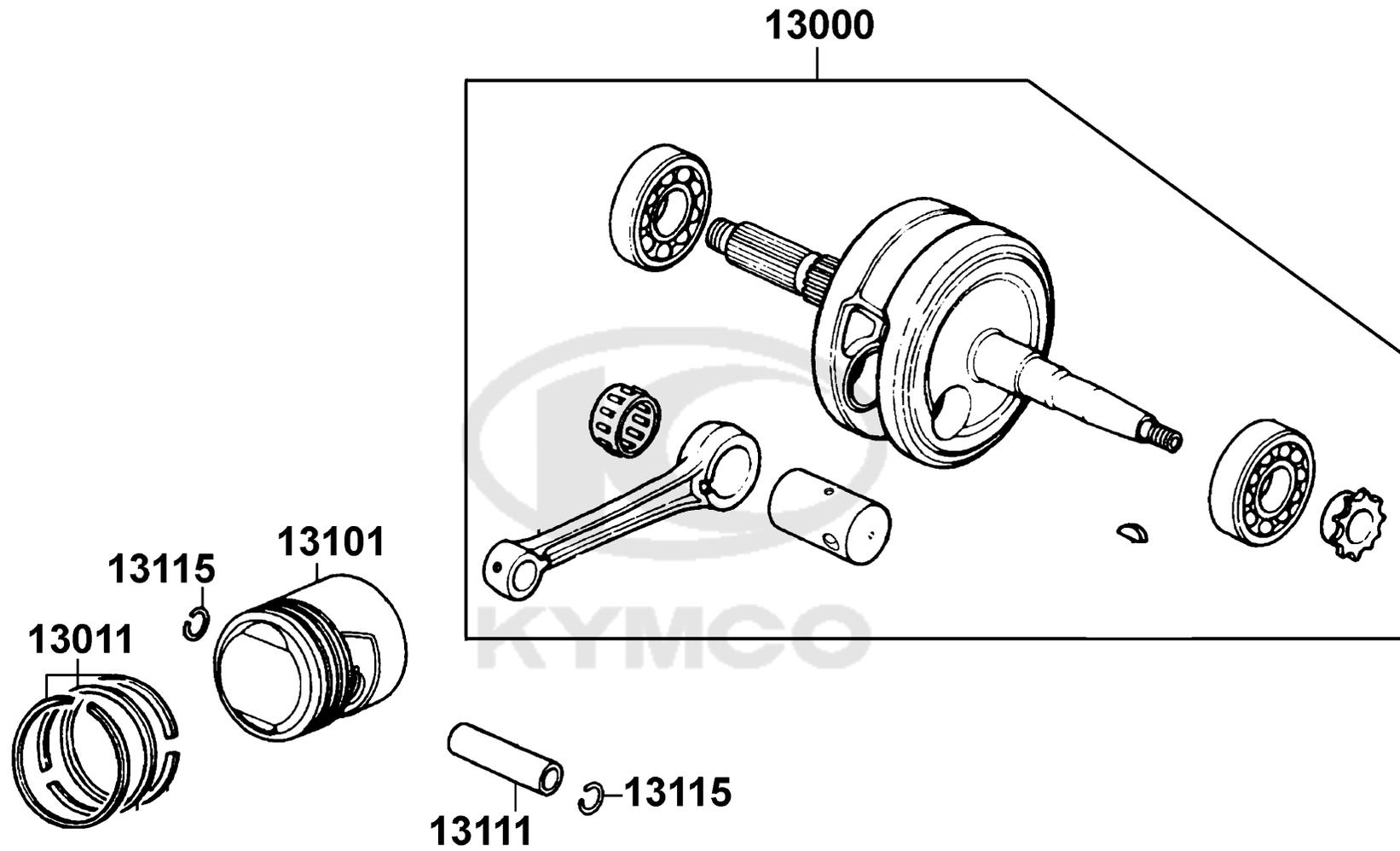

Sales mark	Ref no	Part no	Description	Reg description	Regd no	E15
13000		13000-LBA8-C10	CRANK SHAFT COMP	CRANK SHAFT COMP	1	
13011		13011-LBA8-C10	PISTON RING SET	PISTON RING SET	1	
13101		13101-LBA8-C10	PISTON	PISTON	1	
13111		13111-LBA8-C10	PIN PISTON	PIN PISTON	1	
13115		13115-0A01-C00	PISTON PIN CLIP	PISTON PIN CLIP	1	



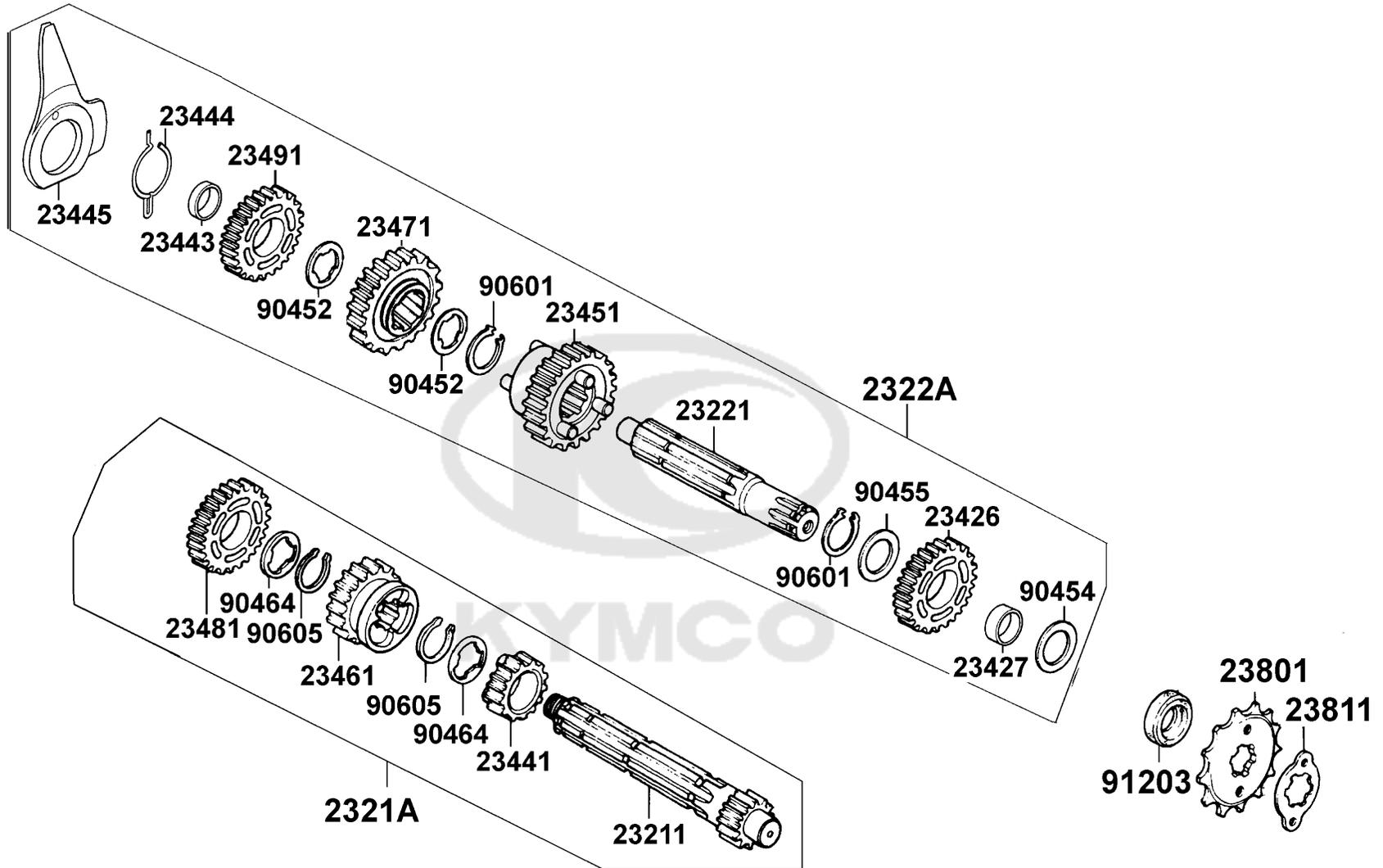

Sales mark	Ref no	Part no	Description	Reg description	Regd no	E16
	23211	23211-LBA8-C10	SHAFT MAIN TRANSMISSION	SHAFT MAIN TRANSMISSION	1	
	2321A	2321A-LBA8-C10	MAIN TRANSMISSION ASSY	MAIN TRANSMISSION ASSY	1	
	23221	23221-LBA8-C10	SHAFT COUNTER TRANSMISSION	SHAFT COUNTER TRANSMISSION	1	
	2322A	2322A-LBA8-C10	COUNTER TRANSMISSION ASSY	COUNTER TRANSMISSION ASSY	1	
	23426	23426-LBA8-C10	GEAR COUNTER SHAFT LOW	GEAR COUNTER SHAFT LOW	1	
	23427	23427-LBA8-C10	COLLAR COUNTER SHAFT LOW GEAR	COLLAR COUNTER SHAFT LOW GEAR	1	
	23441	23441-LBA8-C10	GEAR M-2	GEAR M-2	1	
	23443	23443-LBA8-C10	SLEEVE	SLEEVE	1	
	23444	23444-LBA8-C10	FRICTION SPRING	FRICTION SPRING	1	
	23445	23445-LBA8-C10	CAM LOCATING PLATE	CAM LOCATING PLATE	1	
	23451	23451-LBA8-C10	GEAR C-2	GEAR C-2	1	
	23461	23461-LBA8-C10	GEAR M-3	GEAR M-3	1	
	23471	23471-LBA8-C10	GEAR C-3	GEAR C-3	1	
	23481	23481-LBA8-C10	GEAR M-4	GEAR M-4	1	
	23491	23491-LBA8-C10	GEAR C-4	GEAR C-4	1	
	23801	23801-LBA8-C10	SPROCKET DRIVE	SPROCKET DRIVE	1	
	23811	23811-LBA8-C10	PLATE A2 FIXING	PLATE A2 FIXING	1	
	90452	90452-LBA8-C10	WASHER THRUST 17MM	WASHER THRUST 17MM	1	
	90454	90454-LBA8-C10	WASHER THRUST 17MM	WASHER THRUST 17MM	1	
	90455	90455-LBA8-C10	WASHER SPLINE 20MM	WASHER SPLINE 20MM	1	

E16

Transmission

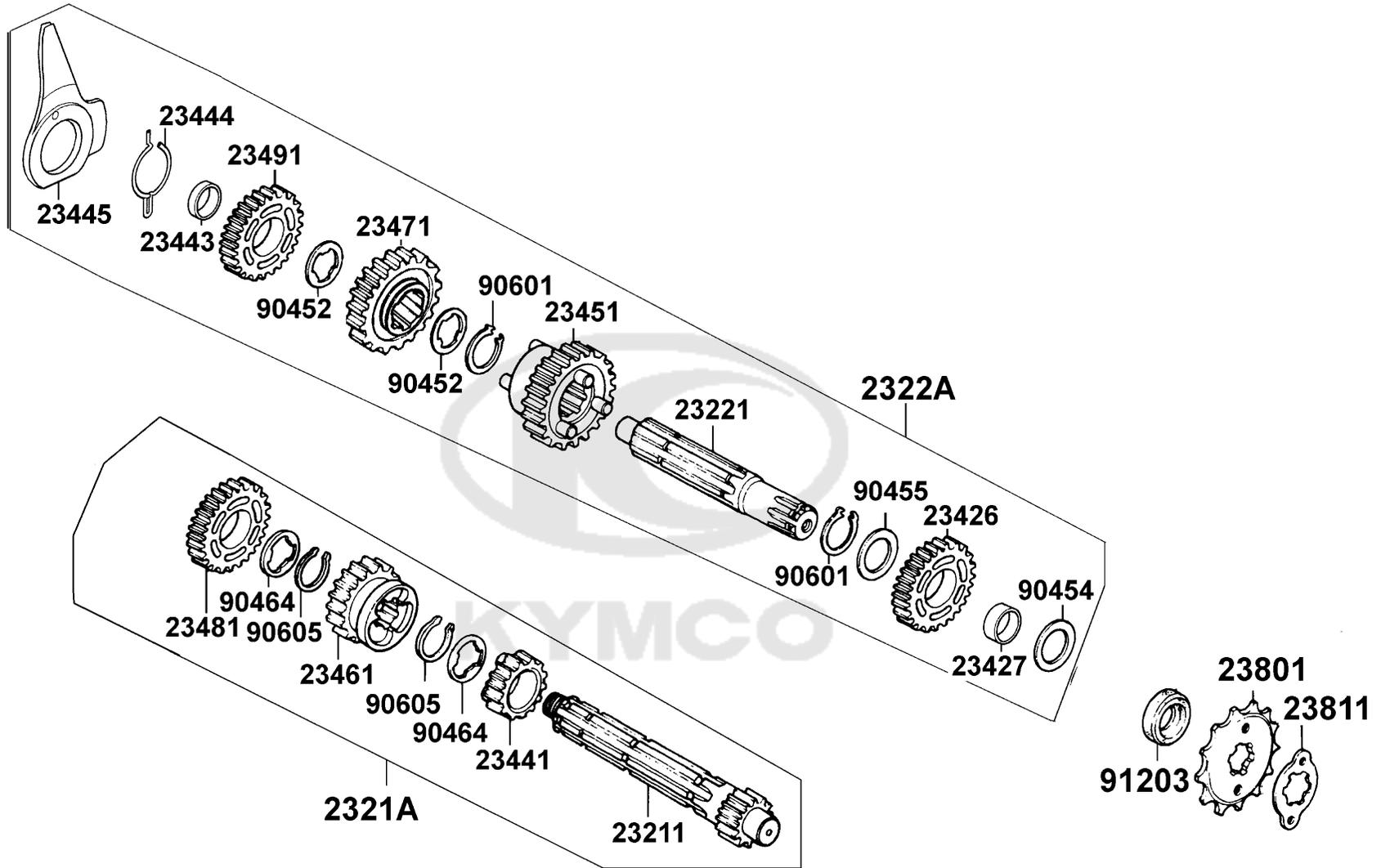

Sales mark	Ref no	Part no	Description	Reg description	Regd no	E16
	90464	90464-LBA8-C10	WASHER SPLINE 17MM	WASHER SPLINE 17MM	1	
	90601	90601-LBA8-C10	SET RING 20MM	SET RING 20MM	1	
	90605	90605-LBA8-C10	SET RING 17MM	SET RING 17MM	1	
	91203	91203-KGB4-C11	OIL SEAL 17*29*5	OIL SEAL 17*29*5	1	
						

E17

Speed change foot bar

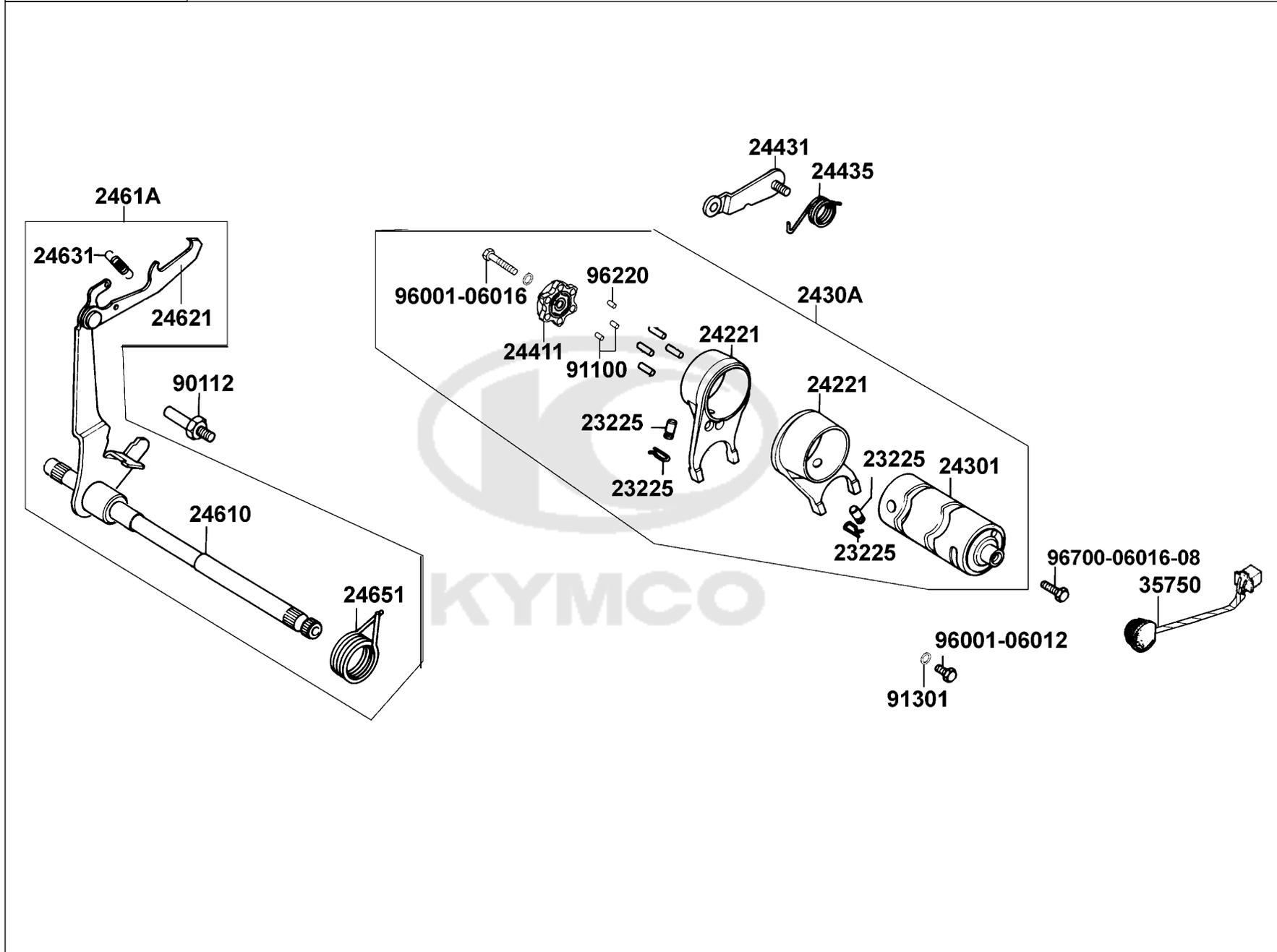

Sales mark	Ref no	Part no	Description	Reg description	Regd no	E17
	23225	23225-LBA8-C10	GUIDE PIN	GUIDE PIN	1	
	24221	24221-LBA8-C10	FORK GEAR SHIFT	FORK GEAR SHIFT	1	
	24301	24301-LBA8-C10	DRUM GEAR SHIFT	DRUM GEAR SHIFT	1	
	2430A	2430A-LBA8-C10	GEAR SHIFT CAM ASSEMBLY	GEAR SHIFT CAM ASSEMBLY	1	
	24411	24411-3D24-C00	CAM GEAR SHIFT	CAM GEAR SHIFT	1	
	24431	24431-LBA8-C10	STOPPER COMP GEAR	STOPPER COMP GEAR	1	
	24435	24435-LBA8-C10	SPRING SHIFT DRUM STOPPER	SPRING SHIFT DRUM STOPPER	1	
	24610	24610-LBA8-C10	PINDLE COMP GEAR SHIFT	PINDLE COMP GEAR SHIFT	1	
	2461A	2461A-LBA8-C10	GEAR SHIFT SPINDLE ASSEMBLY	GEAR SHIFT SPINDLE ASSEMBLY	1	
	24621	24621-1G07-C00	PLATE GEAR SHIFT	PLATE GEAR SHIFT	1	
	24631	24631-1G07-C00	SPRING GEAR SHIFT PLATE	SPRING GEAR SHIFT PLATE	1	
	24651	24651-LBA8-C10	SPRING GEAR SHIFT RETURN	SPRING GEAR SHIFT RETURN	1	
	35750	35750-LBA8-C10	WIRE LEADS SET	WIRE LEADS SET	1	
	90112	90112-LBA8-C10	LOCK SCREW 8*35(K)	LOCK SCREW 8*35(K)	1	
	91100	91100-LBA8-C10	ROLLER 3*8.5	ROLLER 3*8.5	1	
	91301	91301-LBA8-C10	O-RING 15.5*1.6	O-RING 15.5*1.6	1	
	96001-06012	96001-06012-08	BOLT FLANGE 6*12	BOLT FLANGE SH 6*12 (C)	1	
	96001-06016	96001-06016-08	BOLT FLANGE SH 6*16	BOLT FLANGE SH 6*16	1	
	96220	96220-40100	ROLLER 4*10	ROLLER 4*10	1	
	96700	96700-06016-08	BOLT SOCKET 6X16(G)	BOLT SOCKET 6X16(G)	1	

E18

Has moving axis

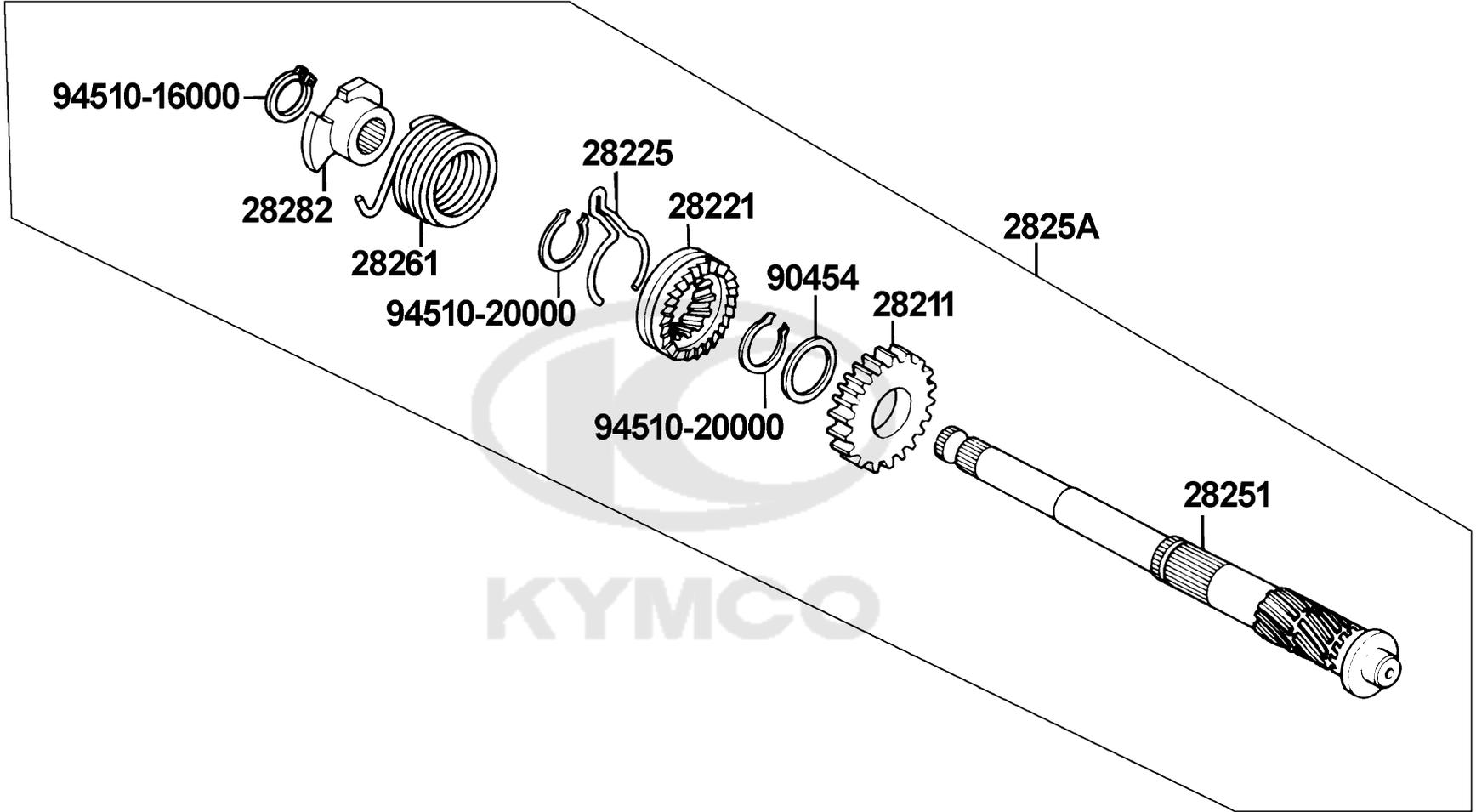

Sales mark	Ref no	Part no	Description	Reg description	Regd no	E18
	28211	28211-LBA8-C10	PINION KICK STARTER	PINION KICK STARTER	1	
	28221	28221-LBA8-C10	RATCHET KICK STARTER	RATCHET KICK STARTER	1	
	28225	28225-LBA8-C10	PLATE KICK STAR	PLATE KICK STAR	1	
	28251	28251-LBA8-C10	DPINDLE KICK STARTER	DPINDLE KICK STARTER	1	
	2825A	2825A-LBA8-C10	KIKK STARTER COMP	KIKK STARTER COMP	1	
	28261	28261-LBA8-C10	SPRING KICK STARTER	SPRING KICK STARTER	1	
	28282	28282-LBA8-C10	COLLAR KICK SPRING	COLLAR KICK SPRING	1	
	90454	90454-1G07-C00	WASHER THRUST 20MM B	WASHER THRUST 20MM B	1	
	94510-16000	94510-16000	CIR CLIP EXTERNAL	CIR CLIP EX 16	1	
	94510-20000	94510-20000	CIR CLIP EX 20	CIR CLIP EXTERNAL 20MM	2	



E19

Carburetor

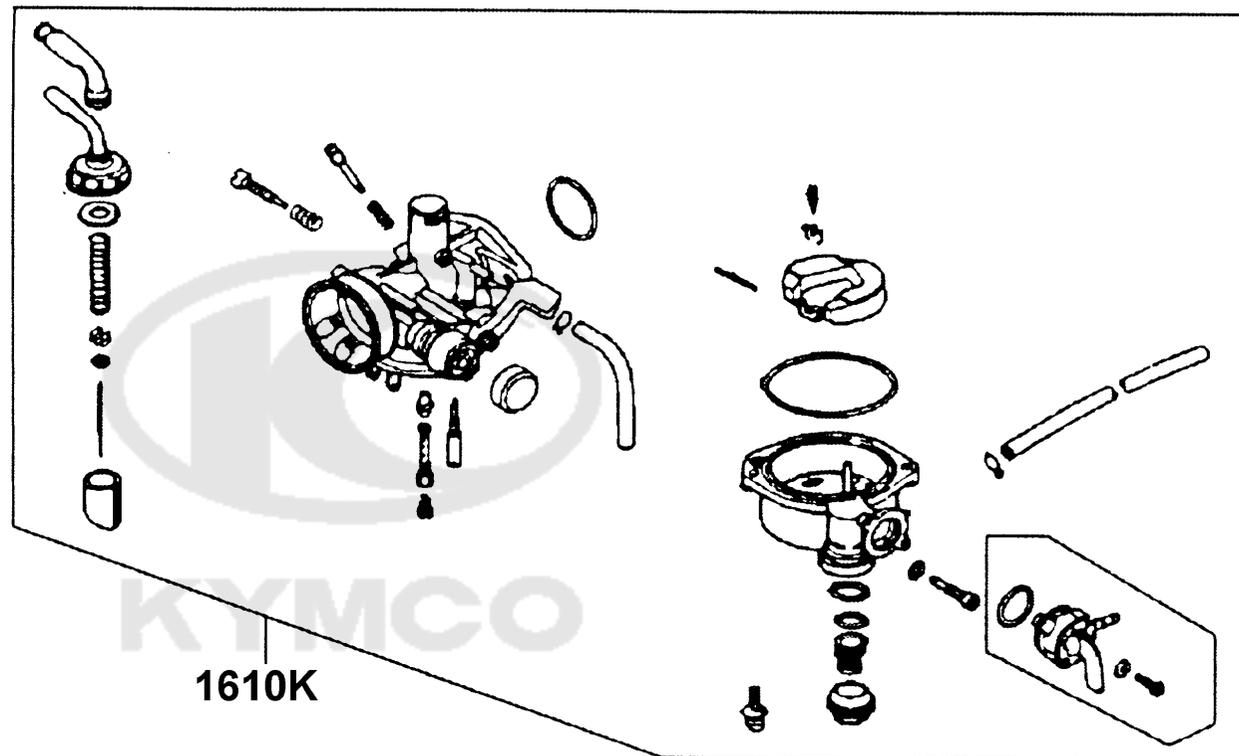
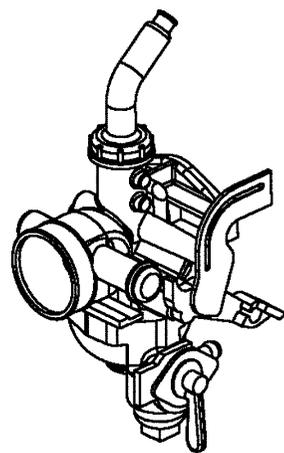

1610K

Sales mark	Ref no	Part no	Description	Reg description	Regd no	E19
------------	--------	---------	-------------	-----------------	---------	------------

1610K

1610K-LBA8-C10

CARBURETOR ASSY

CARBURETOR ASSY

1



F01

Head Light

33100

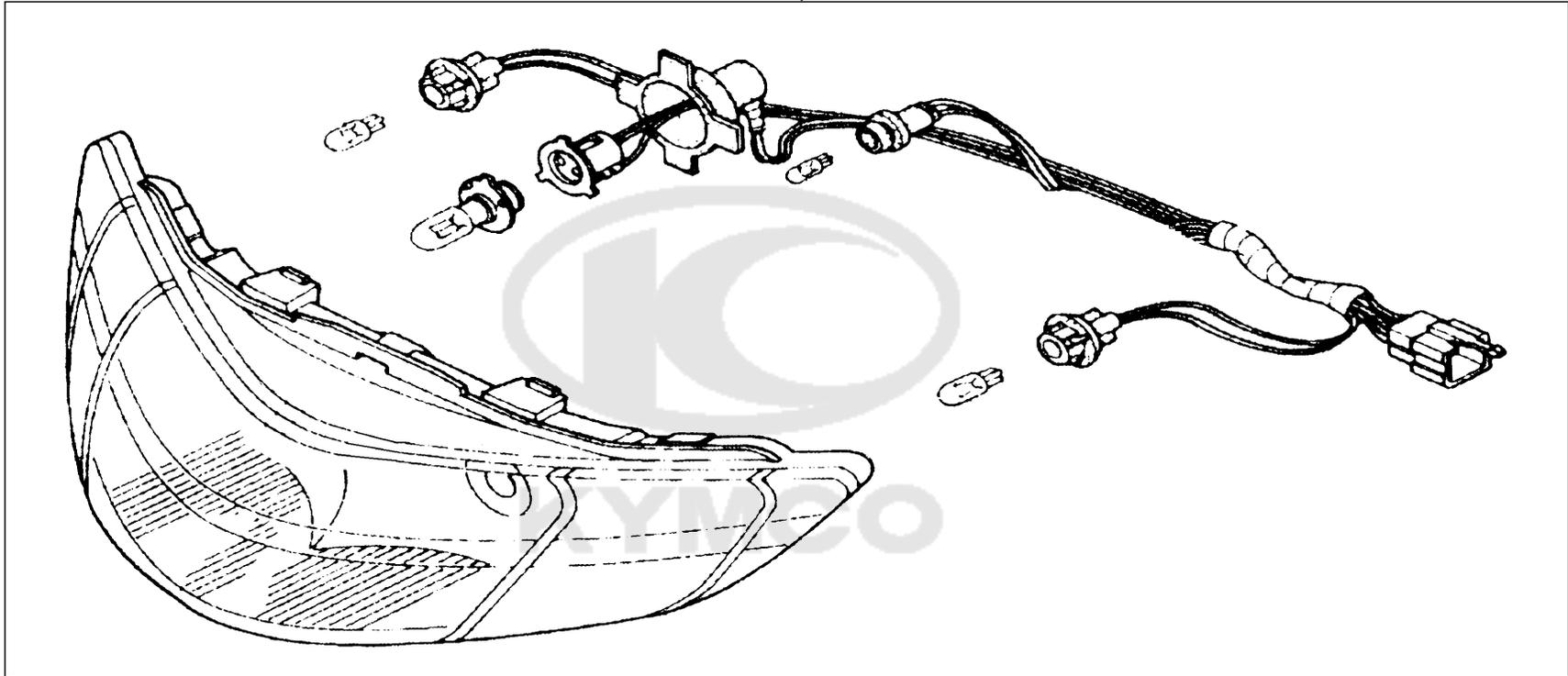

Sales mark	Ref no	Part no	Description	Reg description	Regd no	F01
------------	--------	---------	-------------	-----------------	---------	------------

33100

33100-LBA8-E80

LIGHT ASSY FR COMB

LIGHT ASSY FR COMB

1



F02

Speedometer

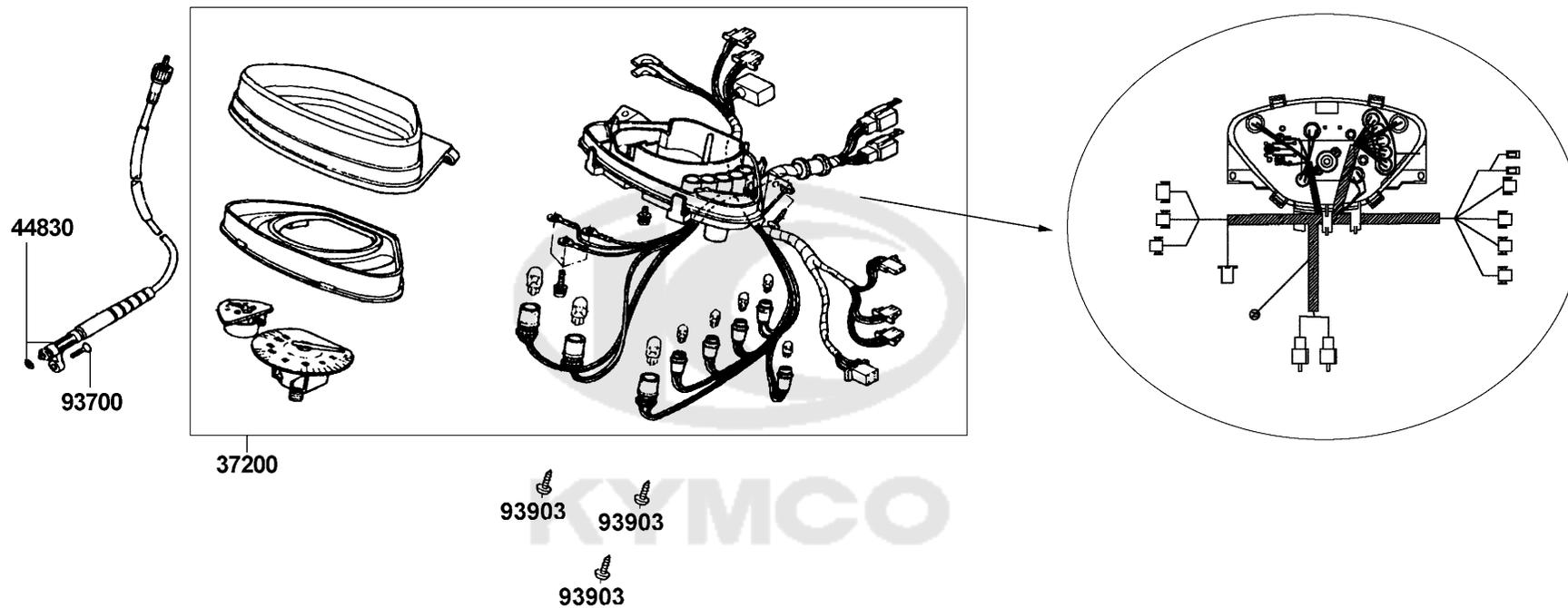

Sales mark	Ref no	Part no	Description	Reg description	Regd no	F02
------------	--------	---------	-------------	-----------------	---------	------------

37200		37200-LBA8-E80	METER SET	METER SET	1	
44830		44830-LBA8-C10	CABLE COMP SPDMT	CABLE COMP SPDMT	1	
93700		93700-05018-08	SCREW OVAL 5*18C	SCREW OVAL 5*18C	1	
93903		93903-35320	SCREW TAPPING 5*16	SCREW TAPPING 5*16	2	



F03

Back MirrorHandle rod

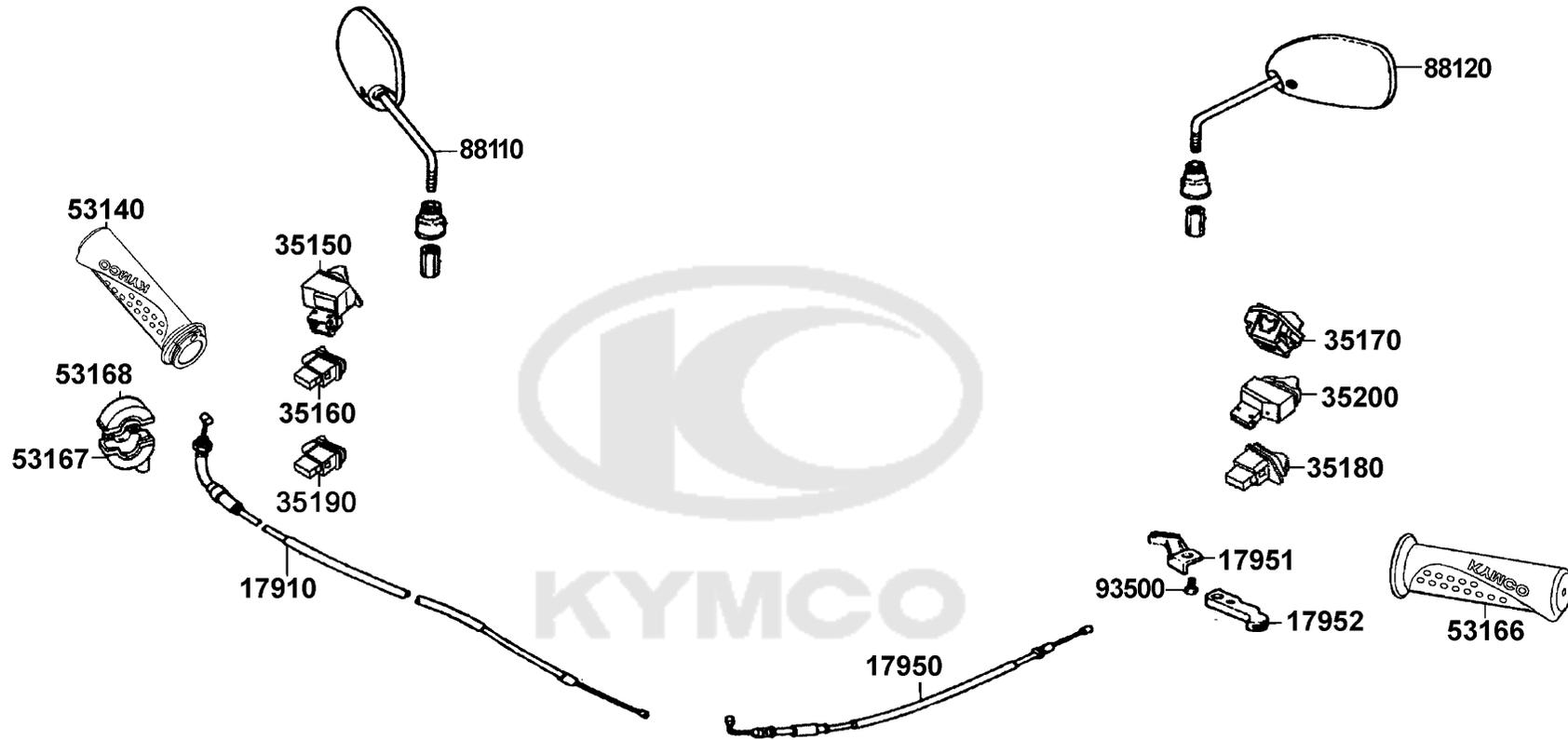

Sales mark	Ref no	Part no	Description	Reg description	Regd no	F03
17910		17910-LBA8-C10	CABLE COMP THROT	CABLE COMP THROT	1	
17950		17950-LBA8-C10	CABLE COMP CHOCK	CABLE COMP CHOCK	1	
17951		17951-LBA8-C10	STOPPER CHOCK CABLE	STOPPER CHOCK CABLE	1	
17952		17952-LBA8-C10	LEVER COMP CHOCK	LEVER COMP CHOCK	1	
35150		35150-GFY6-C00	SW ASSY RH HNDL COMP	SW ASSY RH HNDL COMP	1	
35160		35160-GFY6-C00	SW UNIT START	SW UNIT START	1	
35170		35170-KNBN-C00	SW UNIT DIMMER	SW UNIT DIMMER	1	
35180		35180-GFY6-C00	SW UNIT HORN	SW UNIT HORN	1	
35190		35190-GFY6-C00	SW UNIT HAZARD	SW UNIT HAZARD	1	
35200		35200-GFY6-C00	SW ASSY LH HNDL COMP	SW ASSY LH HNDL COMP	1	
53140		53140-KHC4-C00	GRIP COMP THROT	GRIP COMP THROT	1	
53166		53166-KFA1-C00	GRIP L HANDLE	GRIP L HANDLE	1	
53167		53167-GBN2-C00	HOUSING UND THROT	HOUSING UND THROT	1	
53168		53168-GBN2-C00	HOUSING UP THROT	HOUSING UP THROT	1	
88110		88110-LBA8-E80	MIRROR ASSY R	MIRROR ASSY R	1	
88120		88120-LBA8-E80	MIRROR ASSY L	MIRROR ASSY L	1	
93500-05012		93500-05012-0G	SCREW PAN 5*12 (K)	SCREW PAN 5*12 (K)	1	

F04

Front brake cylinder

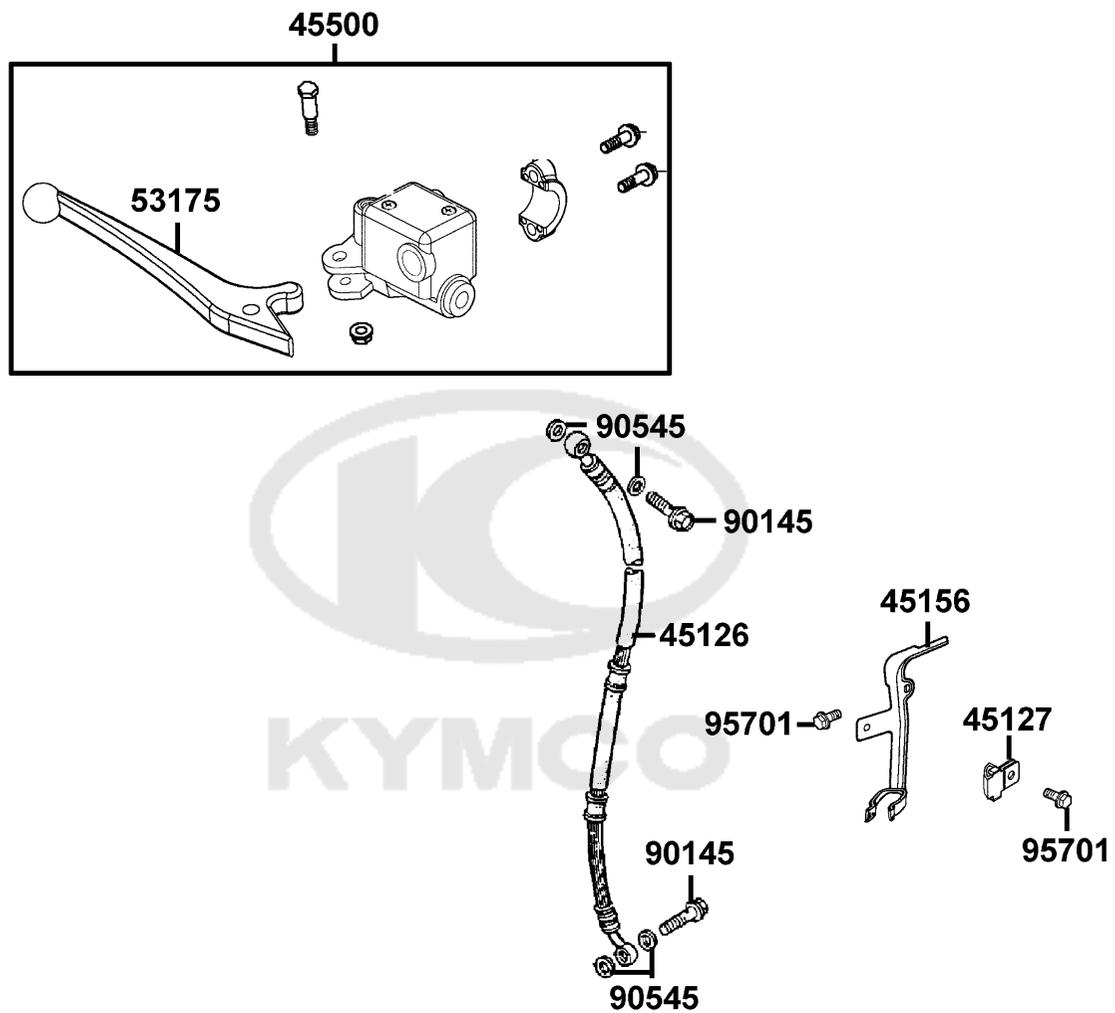

Sales mark	Ref no	Part no	Description	Reg description	Regd no	F04
	45126	45126-LBA8-E80	HOSE ASSY FR BRK	HOSE ASSY FR BRK	1	
	45127	45127-LBA8-C11	CLAMPER FR BRK	CLAMPER FR BRK	1	
	45156	45156-LBA8-C11	CLAMPER A FR BRK	CLAMPER A FR BRK	1	
	45500	45500-LBA8-E80	CYLINDER ASSY FR	CYLINDER ASSY FR	1	
**	53175	53175-LBA8-C11	LEVER R STRG HANDLE	LEVER R STRG HANDLE	1	
	90145	90145-9A61-C00	OIL BOLT 10*22	OIL BOLT 10*22	1	
	90545	90545-3L00-C00	WASHER OIL BOLT	WASHER OIL BOLT	1	
	95701	95701-06012-08	BOLT FLANGE 6*12	BOLT FLANGE 6*12	1	



F05

Changes handle handle covers

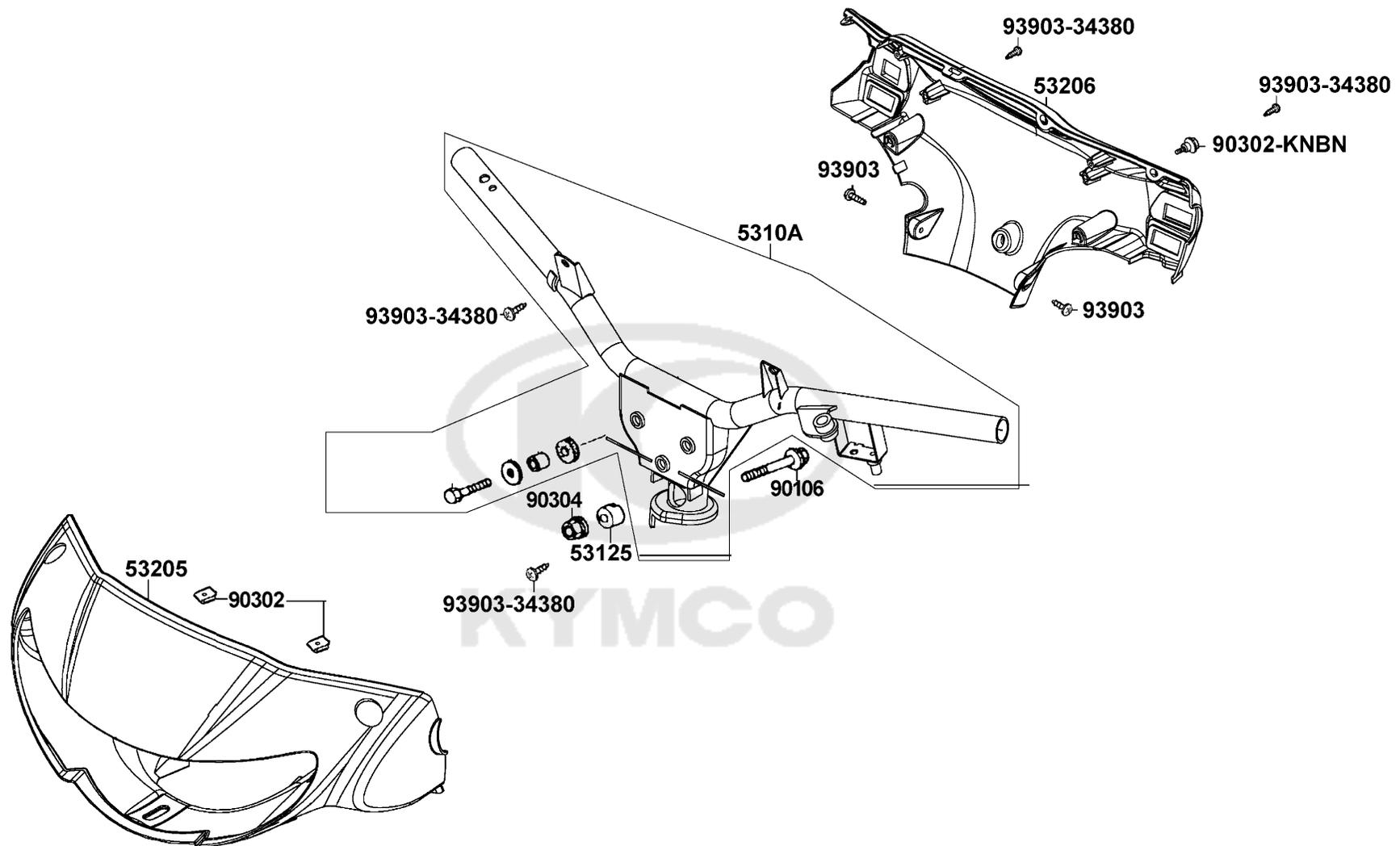

Sales mark	Ref no	Part no	Description	Reg description	Regd no	F05
	5310A	5310A-LBA8-C10	HANDLE COMP STEERING	HANDLE COMP STEERING	1	
	53125	53125-GEN5-C00	COLLAR HANDLE SET	COLLAR HANDLE SET	1	
**	53205	53205-LBA8-305	COVER FR HANDLE	COVER FR HANDLE	1	
**	53205	53205-LBA8-C10	COVER FR HANDLE	COVER FR HANDLE	1	
**	53206	53206-LBA8-C10	COVER RR HANDLE	COVER RR HANDLE	1	
	90106	90106-GEN5-901	BOLT FLANGE 10*50	BOLT FLANGE 10*50	1	
	90302-KNBN	90302-KNBN-C00	BOLT PAN 5*10	BOLT PAN 5*10	1	
	90302-SDA4	90302-SDA4-C00	NUT SPRING 4MM	NUT SPRING 4MM	1	
	90304	90304-GHE8-C00	NUT U 10MM(C)	NUT U 10MM(C)	1	
	93903-14380	93903-14380	SCREW TAPPING 4*12 (K)	SCREW TAPPING 4*12 (K)	2	
	93903-34380	93903-34380	SCREW TAPPING 4*12	SCREW TAPPING 4*12	4	

F06

Stem Steering

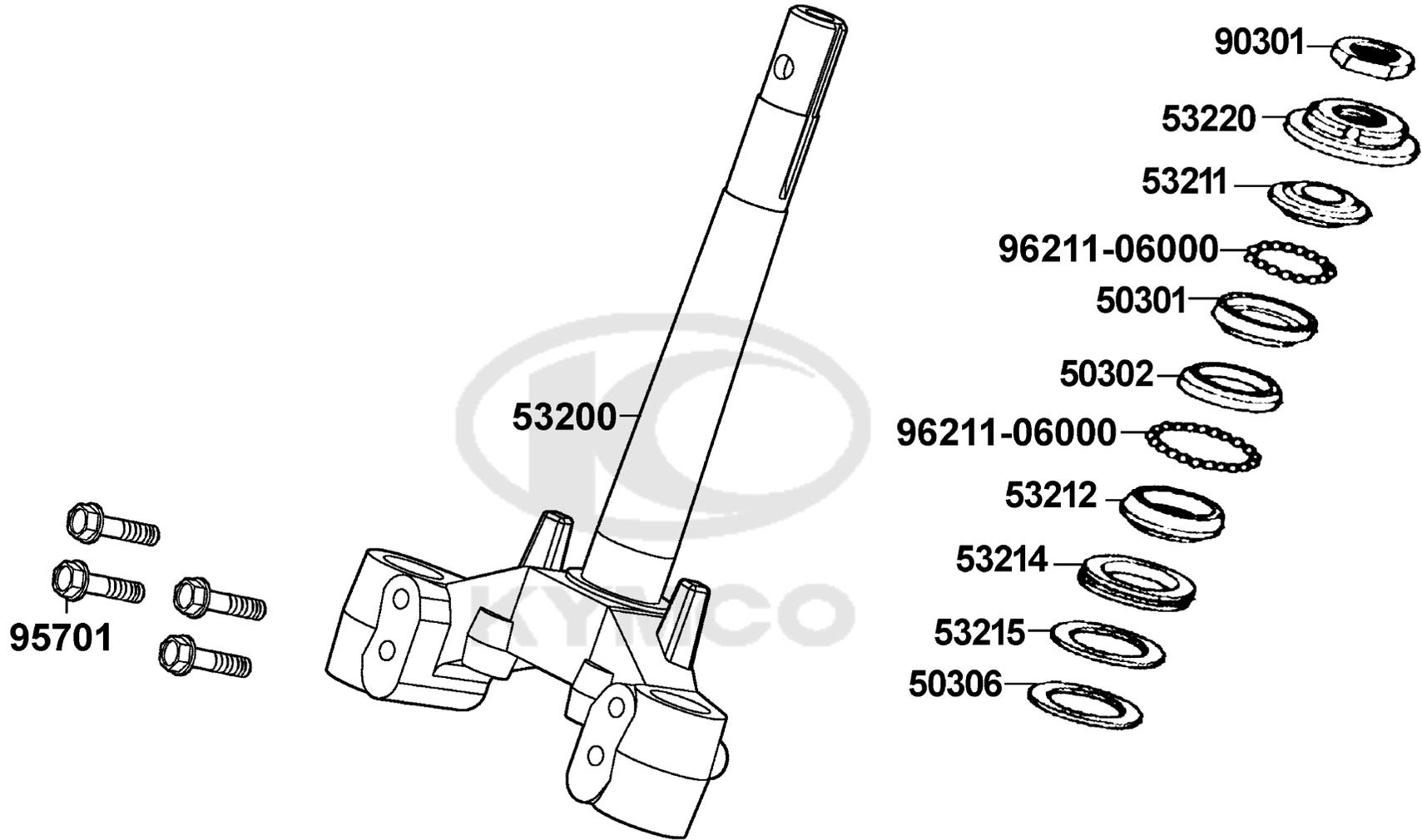

Sales mark	Ref no	Part no	Description	Reg description	Regd no	F06
50301		50301-LBA8-C10	RACE UPPER STRG BALL	RACE UPPER STRG BALL	1	
50302		50302-LBA8-C10	RACE BOT STRG BALL	RACE BOT STRG BALL	1	
50306		50306-LBA8-C10	WASHER STRG	WASHER STRG	1	
53200		53200-LBA8-C11	STEM COMP STRG	STEM COMP STRG	1	
53211		53211-LBA8-C10	RACE STRG TOP CONE	RACE STRG TOP CONE	1	
53212		53212-LBA8-C10	RACE STRG BOT CONE	RACE STRG BOT CONE	1	
53214		53214-LBA8-C10	DUST SEAL STRG HEAD	DUST SEAL STRG HEAD	1	
53215		53215-LBA8-C10	WASHER STRG HNDL	WASHER STRG HNDL	1	
53220		53220-LBA8-C10	THREAD STRG HEAD TOP	THREAD STRG HEAD TOP	1	
90301		90301-LBA8-C10	NUT STRG STEM	NUT STRG STEM	1	
95701		95701-10045-08	BOLT FLANGE 10*45(C)	BOLT FLANGE 10*45(C)	4	
96211-06000-D		96211-06000-D	BALL STEEL 6	BALL STEEL 6	1	
96211-06000-U		96211-06000-U	BALL STEEL 6	BALL STEEL 6	1	

F07

Front Fender

33741



90301

93404-06016-07



93404-06016-07



61100

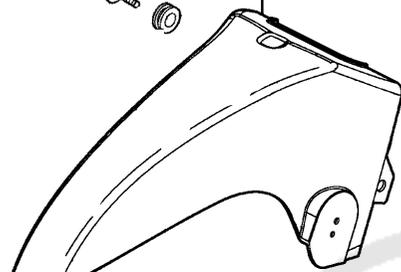

61101

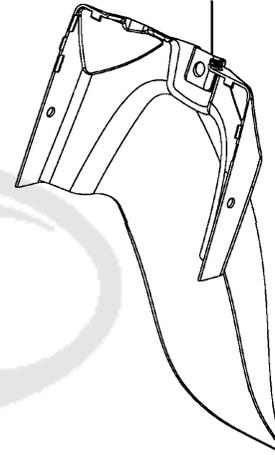

93404-06016-07



90301



33741



93404-06016-07



KIMCO

64114

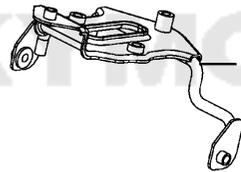

95701-06025



95701-06020

Sales mark	Ref no	Part no	Description	Reg description	Regd no	F07
	33741	33741-GFY6-C00	REFLEX REFLECTOR	REFLEX REFLECTOR	1	
**	61100	61100-LBA8-900	FENDER A FR	FENDER A FR	1	
**	61101	61101-LBA8-900	FENDER B FR	FENDER B FR	1	
	64114	64114-LBA8-C10	STAY B FR FENDER	STAY B FR FENDER	1	
	90301	90301-6D34-C00	NUT FLANGE 6MM	NUT FLANGE 6MM	1	
	93404	93404-06016-08	BOLT WASHER 6*16	BOLT WASHER 6*16 (C)	4	
	95701-06020	95701-06020-08	SCREW FLANGE 6*20	BOLT FLANGE 6*20 ?	2	
	95701-06025	95701-06025-08	BOLT FLANGE 6*25	BOLT FLANGE 6*25	1	



Sales mark	Ref no	Part no	Description	Reg description	Regd no	F08
------------	--------	---------	-------------	-----------------	---------	------------

5140A	5140A-LBA8-E81	5140A-LBA8-E81	FORK ASSY R FR	FORK ASSY R FR	1	
5150A	5150A-LBA8-E81	5150A-LBA8-E81	FORK SET L FR	FORK SET L FR	1	



F09

Front brake calibre

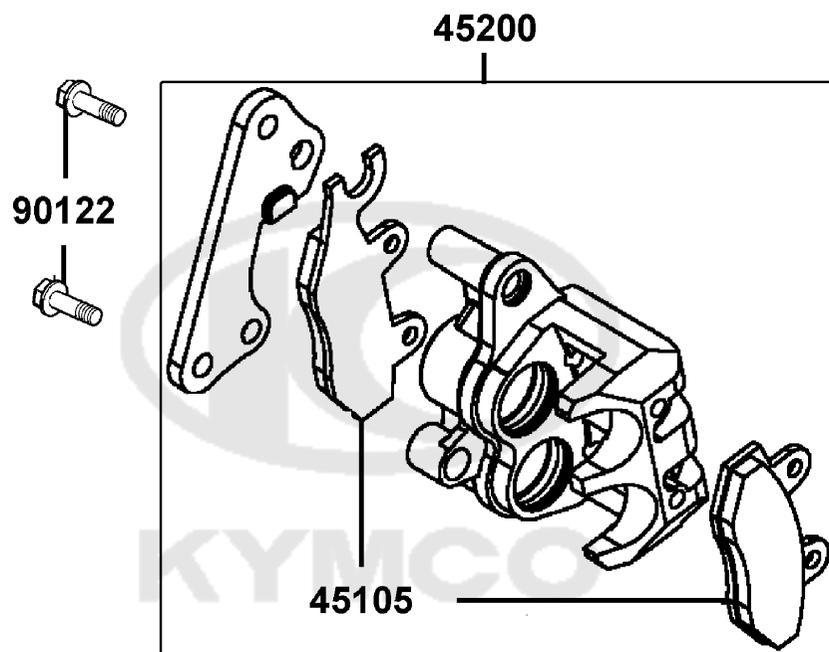

Sales mark	Ref no	Part no	Description	Reg description	Regd no	F09
------------	--------	---------	-------------	-----------------	---------	------------

	45105	45105-LBA8-305	PAD COMP A&B	PAD COMP A+B	1	
**	45200	45200-LBA8-C10	CALIPER ASSY FR	CALIPER ASSY FR	1	
	90122	90122-KGD4-C11	BOLT FLANGE 8*25 (C)	BOLT FLANGE 8*25 (C)	1	



F10

Front WheelAI

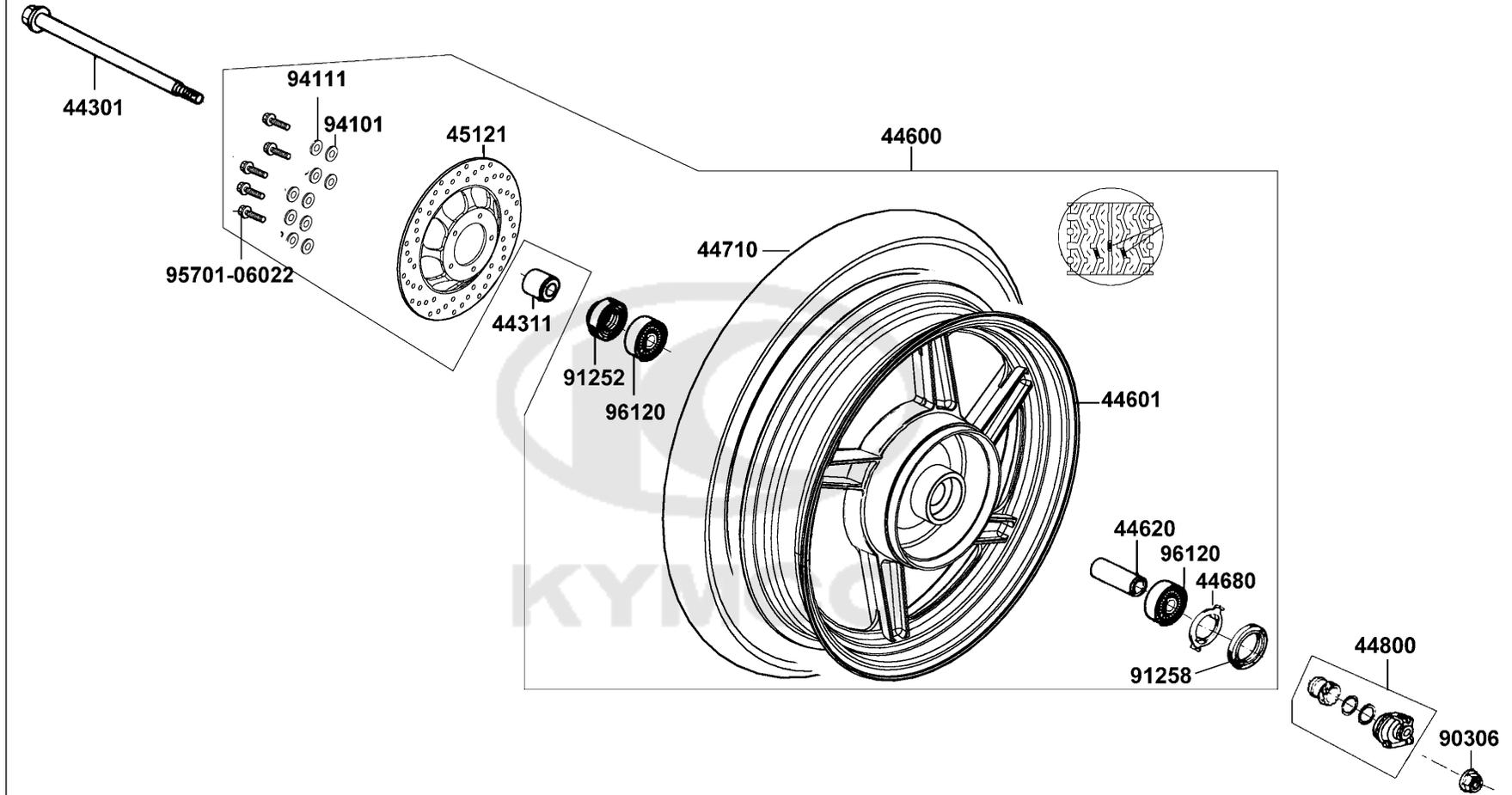

Sales mark	Ref no	Part no	Description	Reg description	Regd no	F10
	44301	44301-LBA8-C11	AXLE FR WHEEL	AXLE FR WHEEL	1	
	44311	44311-LBA8-C11	COLLAR FR WHEEL SIDE	COLLAR FR WHEEL SIDE	1	
	44600	44600-LBA8-E81	WHEEL ASSY FR	WHEEL ASSY FR	1	
	44601	44601-LBA8-C11	WHEEL COMP FR CAST	WHEEL COMP FR CAST	1	
	44620	44620-LBA8-C11	COLLAR FR DIST	COLLAR FR DIST	1	
	44680	44680-LBA8-C11	RETAINER GEAR BOX	RETAINER GEAR BOX	1	
	44710	44710-LBA8-E81	TIRE ASSY FR2.50-17(HF314A)	TIRE ASSY FR2.50-17(HF314A)	1	
**	44800	44800-LBA8-C11	GEAR BOX ASSY	GEAR BOX ASSY	1	
	45121	45121-LBA8-C11	DISK FR BRK	DISK FR BRK	1	
	90306	90306-KLF0-C00	NUT FLANGE 12MM	NUT FLANGE 12MM	1	
	91252	91252-LBA8-C11	OIL SEAL WHEEL 20*37*7	OIL SEAL WHEEL 20*37*7	1	
	91258	91258-4L10-007	DUST SEAL 40*50*5	DUST SEAL 40*50*5	1	
	94101	94101-06800	WASHER PLAIN 6MM	WASHER PLAIN 6MM (C)	1	
	94111	94111-06800	WASHER SPG 6MM	WASHER SPG 6MM	5	
	95701-06022	95701-06022-08	BOLT FLANGE 6*22	BOLT FLANGE 6*22	1	
	96120	96120-63010-10	BEARING BALL RADIAL 6301	BEARING BALL RADIAL 6301	2	

F11

Latter braking vane

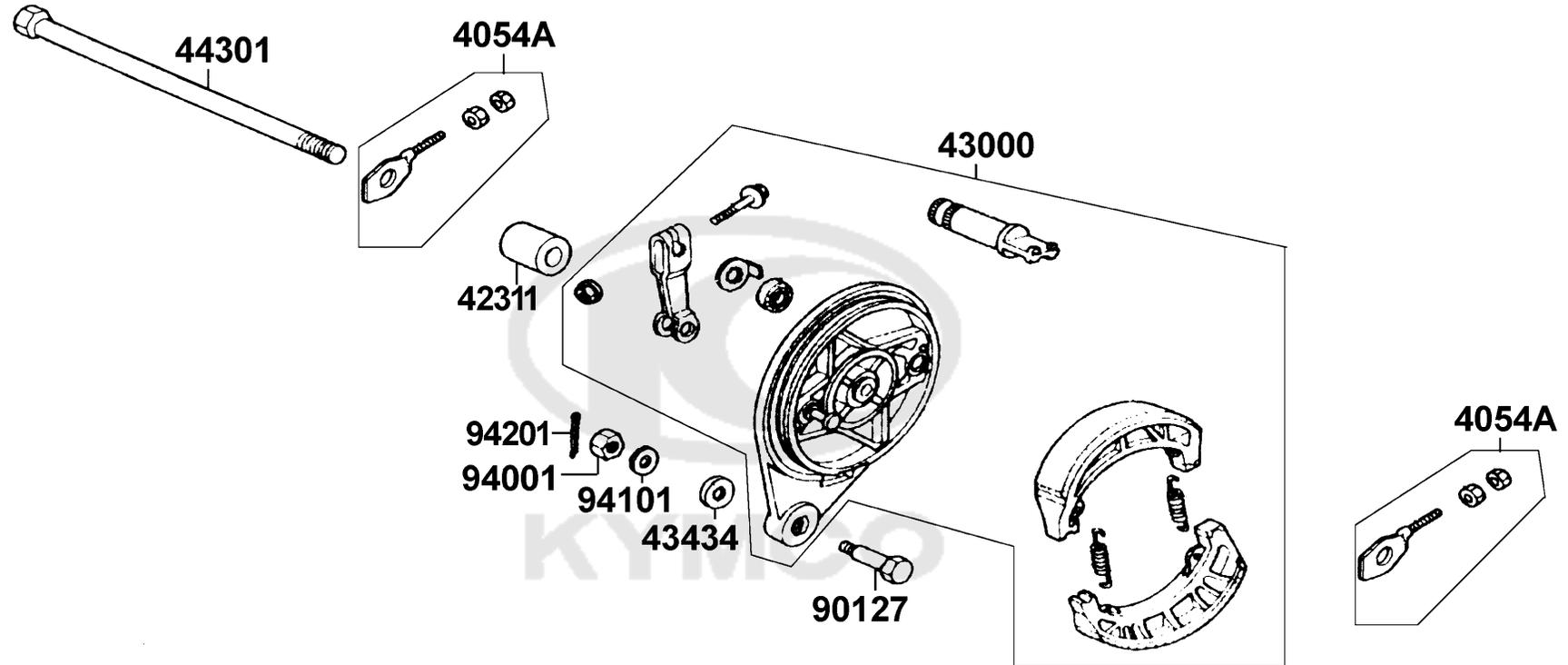

Sales mark	Ref no	Part no	Description	Reg description	Regd no	F11
	4054A	4054A-LBA8-C10	DRIVE CHAIN ADJUSTER ASSY	DRIVE CHAIN ADJUSTER ASSY	1	
	42311	42311-LBA8-C11	COLLAR RR PANEL SIDE	COLLAR RR PANEL SIDE	1	
**	43000	43000-LBA8-E80	PANEL ASSY RR BRK	PANEL ASSY RR BRK	1	
	43434	43434-2F86-C00	RUBBER STOPPER ARM CUSHION	RUBBER STOPPER ARM CUSHION	1	
	44301	44301-KFW6-C00	AXLE FR WHEEL(MFZn2-B)	AXLE FR WHEEL(MFZn2-B)	1	
	90127	90127-LBA8-C10	BOLT FLANGE8*30	BOLT FLANGE8*30	1	
	94001	94001-08080-0S	NUT HEX 8MM	NUT HEX 8MM (C)	1	
	94101	94101-08800	WASHER PLAIN 8MM	WASHER PLAIN 8MM (C)	1	
	94201	94201-20150	PIN SPLIT 2*15	PIN SPLIT 2* 15	1	



F12

Rear WheelAI

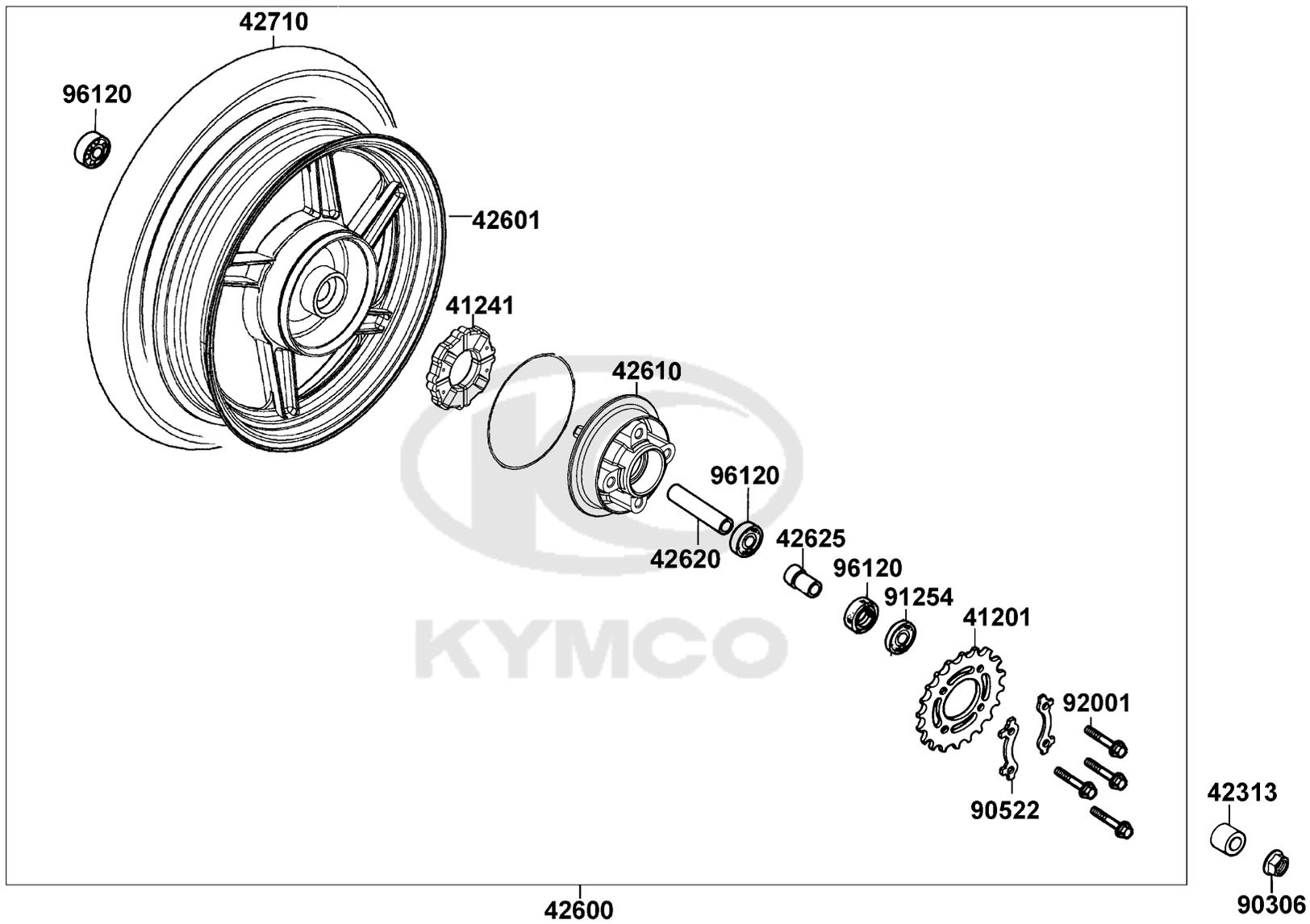

Sales mark	Ref no	Part no	Description	Reg description	Regd no	F12
	41201	41201-LBA8-C10	SPRKT DRIVEN 36T	SPRKT DRIVEN 36T	1	
	41241	41241-LBA8-C10	DAMPER RR WHEEL	DAMPER RR WHEEL	1	
	42313	42313-LBA8-C11	COLLAR RR HUB SIDE	COLLAR RR HUB SIDE	1	
	42600	42600-LBA8-C11	WHEEL ASSY RR	WHEEL ASSY RR	1	
**	42601	42601-LBA8-C11	WHEEL COMP RR CAST	WHEEL COMP RR CAST	1	
**	42610	42610-LFD6-C50	SPRKT HUB ASSY	SPRKT HUB ASSY	1	
	42620	42620-LBA8-C11	COLLAR RR DIST	COLLAR RR DIST	1	
	42625	42625-LBA8-C11	SLEEVE SPRKT HUB	SLEEVE SPRKT HUB	1	
	42710	42710-LBA8-C10	TIRE ASSY RR	TIRE ASSY RR	1	
	90306	90306-KLF0-C00	NUT FLANGE 12MM	NUT FLANGE 12MM	1	
	90522	90522-LBA8-C10	WASHER TONGUED 8MM	WASHER TONGUED 8MM	1	
	91254	91254-LBA8-C10	DUST SEAL	DUST SEAL RR WHEEL	1	
	92001	92001-LBA8-C10	BOLT FLANGE 8*35 (C)	BOLT FLANGE 8*35 (C)	4	
	96120	96120-63010-10	BEARING BALL RADIAL 6301	BEARING BALL RADIAL 6301	2	

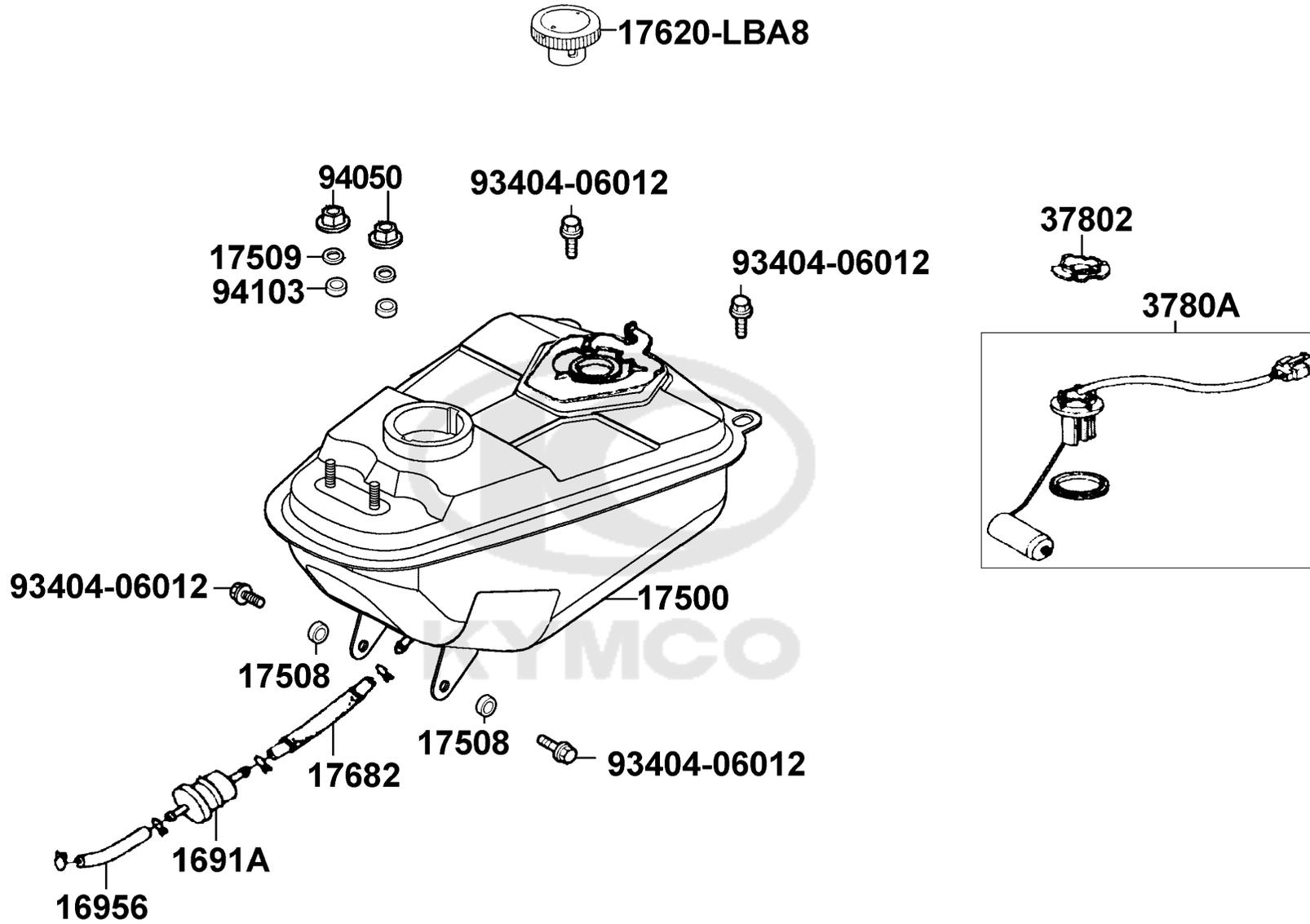

Sales mark	Ref no	Part no	Description	Reg description	Regd no	F13
1691A		1691A-GFY6-C00	STRAINER ASSY FUEL	STRAINER ASSY FUEL	1	
16956		16956-LBA8-C10	TUBE FUEL (STRAIN TO CARB)	TUBE FUEL (STRAIN TO CARB)	1	
17500		17500-LBA8-C10	TANK COMP FUEL	TANK COMP FUEL	1	
17508		17508-LBA8-C10	DAMPING MAT SEAT CUSHION	DAMPING MAT SEAT CUSHION	1	
17509		17509-LBA8-C10	TANK COLLAR	TANK COLLAR	1	
17620		17620-LBA8-C10	CAP FUEL FILLER	CAP FUEL FILLER	1	
17682		17682-LBA8-C10	TUBE FUEL (TANK TO STRAIN)	TUBE FUEL (TANK TO STRAIN)	1	
37802		37802-LBA8-C10	RET FUEL UNIT	RET FUEL UNIT	1	
3780A		3780A-LBA8-C10	FUEL UNIT ASSY	FUEL UNIT ASSY	1	
93404		93404-06012-08	BOLT WASHER 6*12	BOLT WASHER 6*12 (C)	4	
94050		94050-06080	NUT FLANGE 6MM	NUT FLANGE 6MM	2	
94103		94103-06800	WASH PLAIN 6MM	SPECIAL WASHERC	2	

F14

SeatRear frame

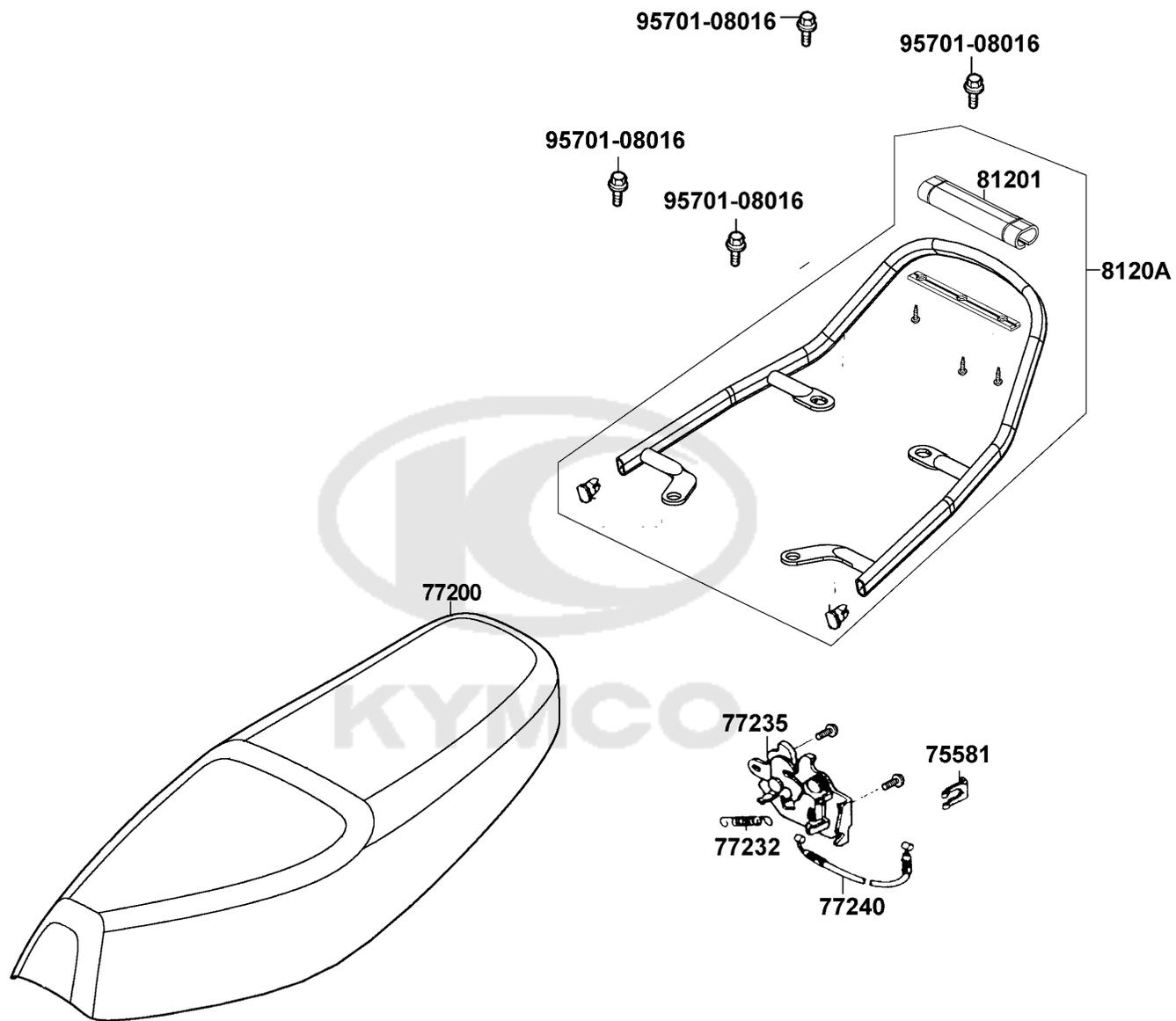

Sales mark	Ref no	Part no	Description	Reg description	Regd no	F14
	75581	75581-6C73-C00	SET SPG LOCK KET(43*C)	SET SPG LOCK KET(43*C)	1	
**	77200	77200-LBA8-E80	SEAT ASSY	SEAT ASSY	1	
	77232	77232-LLC5-C10	STAY SEAT LOCK	STAY SEAT LOCK	1	
	77235	77235-LBA8-C10	SEAT CATCH COMP	SEAT CATCH COMP	1	
	77240	77240-GGS7-C11	CABLE SEAT LOCK	CABLE SEAT LOCK	1	
	81201	81201-LBA8-C10	GRIP RR	GRIP RR	1	
	8120A	8120A-LBA8-E80	RR CARRIER ASSY	RR CARRIER ASSY	1	
	95701	95701-08016-08	BOLT FLANGE 8*16 (C)	BOLT FLANGE 8*16 (C)	4	

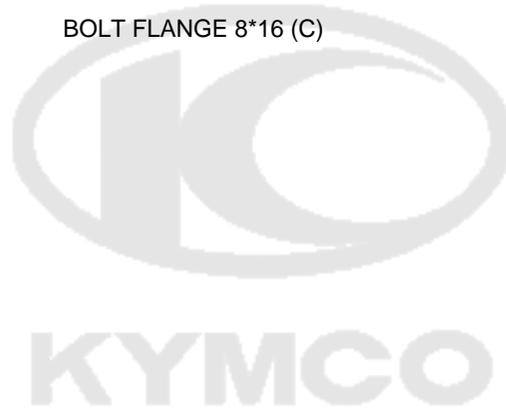

F15

Front coverside cover

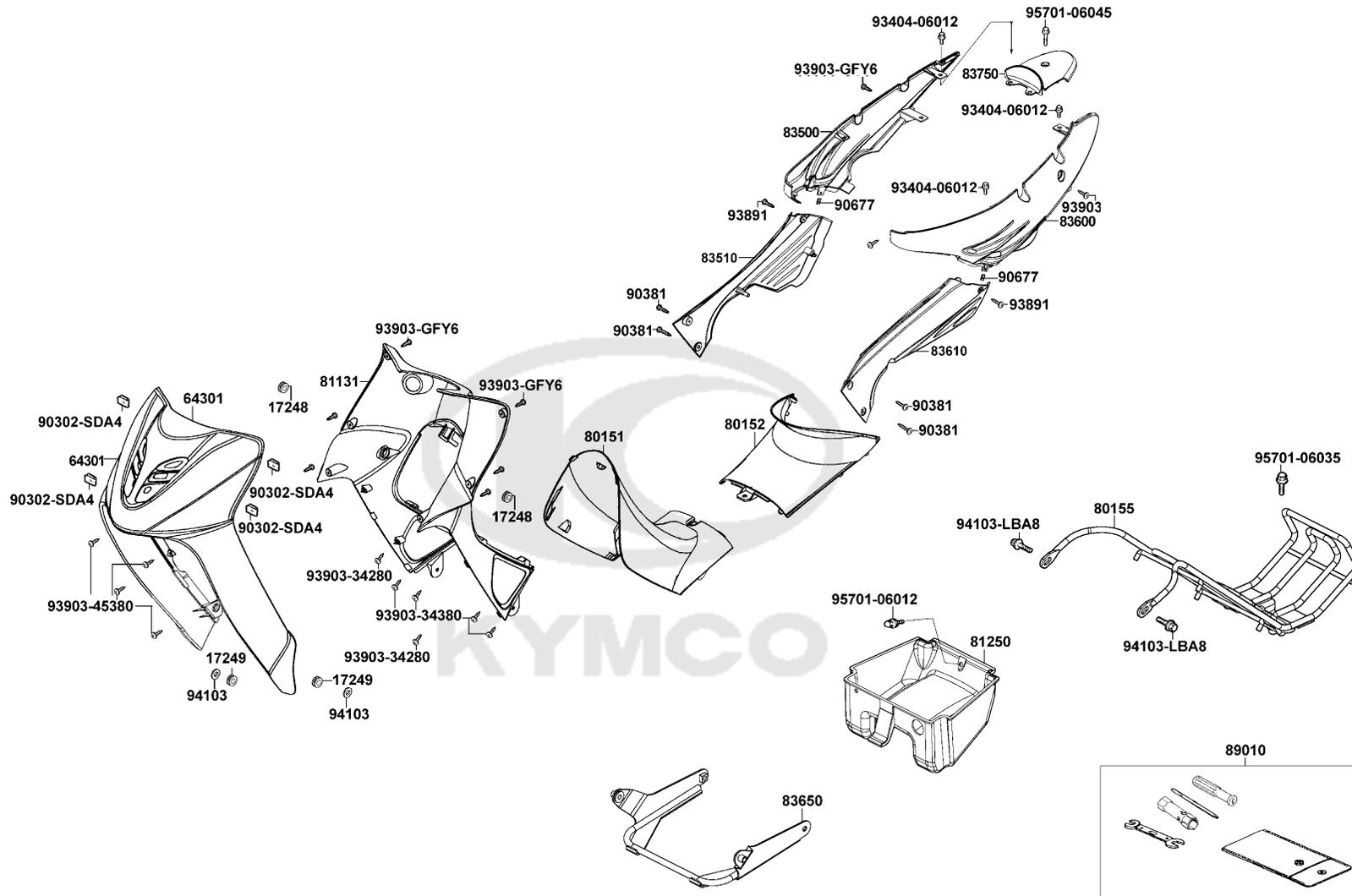

Sales mark	Ref no	Part no	Description	Reg description	Regd no	F15
	17248	17248-LBA8-C00	GROMMET B PILLION STEP BRACKET	GROMMET B PILLION STEP BRACKET	1	
	17249	17249-LBA8-C10	GROMMET COLLAR FR	GROMMET COLLAR FR	1	
**	64301	64301-LBA8-306	COVER FR (NH045/RR136)	COVER FR (NH045/RR136)	1	
**	64301	64301-LBA8-C10	COVER FR	COVER FR	1	
**	80151	80151-LBA8-C10	COVER CENTER UP	COVER CENTER UP	1	
**	80152	80152-LBA8-C10	COVER CENTER LOW	COVER CENTER LOW	1	
	80155	80155-LBA8-C10	CARRIER LUGGAGE	CARRIER LUGGAGE	1	
**	81131	81131-LBA8-C10	LEG SHIELD	LEG SHIELD	1	
**	81250	81250-LBA8-C10	BOX LUGGAGE	BOX LUGGAGE	1	
**	83500	83500-LBA8-306	COVER R BODY	COVER R BODY	1	
**	83500	83500-LBA8-C10	COVER R BODY	COVER R BODY	1	
**	83510	83510-LBA8-307	COVER R SIDE	COVER R SIDE	1	
**	83510	83510-LBA8-C10	COVER R SIDE	COVER R SIDE	1	
**	83600	83600-LBA8-306	COVER L BODY	COVER L BODY	1	
**	83600	83600-LBA8-C10	COVER L BODY	COVER L BODY	1	
**	83610	83610-LBA8-307	COVER L BODY SIDE(NH045/NH001)	COVER L BODY SIDE(NH045/NH001)	1	
**	83610	83610-LBA8-C10	COVER L SIDE	COVER L SIDE	1	
	83650	83650-LBA8-C000	WINDSHIELD SUPPORT	WINDSHIELD SUPPORT	1	
**	83750	83750-LBA8-C10	COVER CENTER RR	COVER CENTER RR	1	
	89010	89010-KGB4-C00	TOOL SET	TOOL SET	1	

F15

Front coverside cover

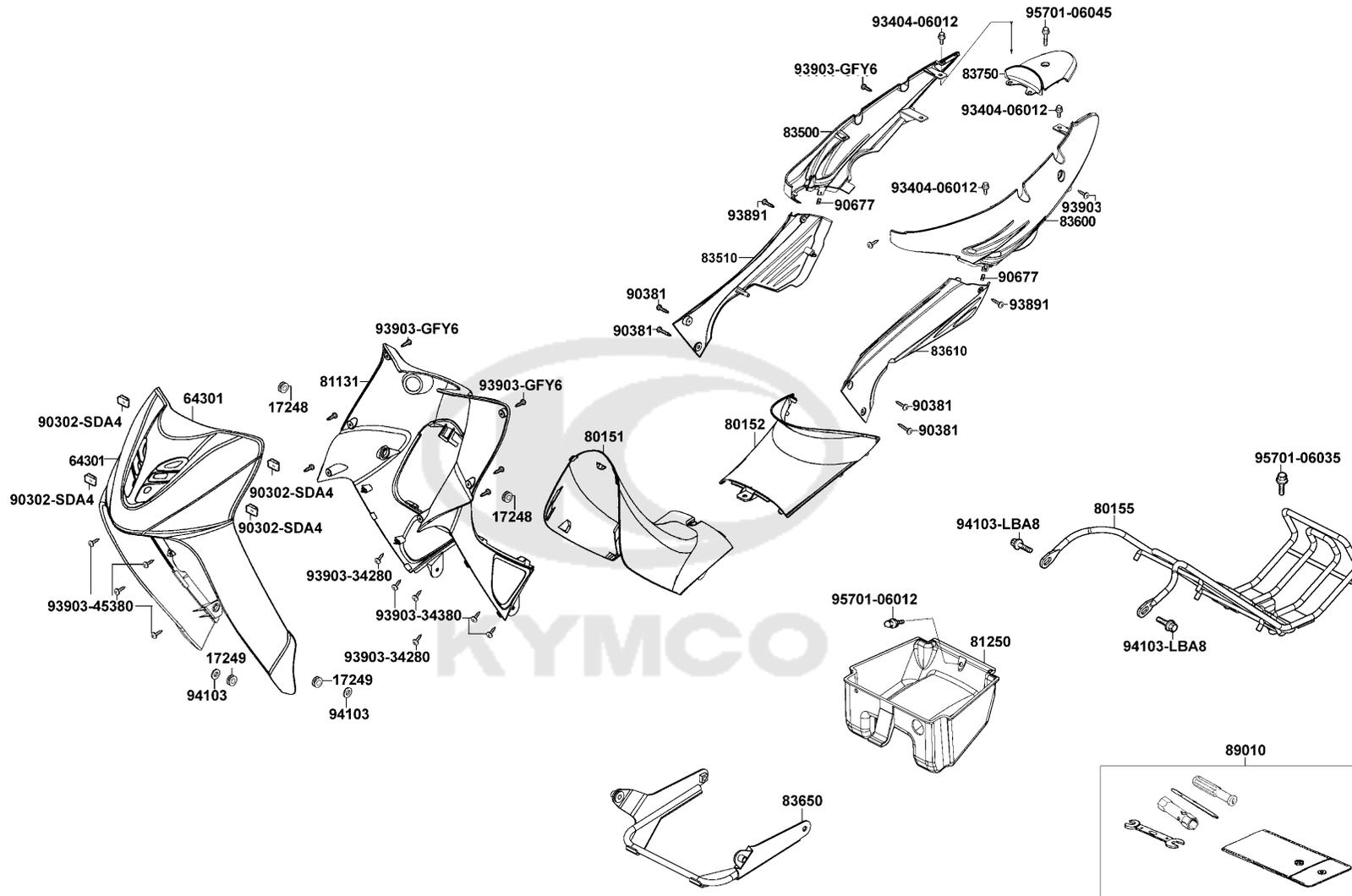

Sales mark	Ref no	Part no	Description	Reg description	Regd no	F15
	90302-SDA4	90302-SDA4-C00	NUT SPRING 4MM	NUT SPRING 4MM	1	
	90381	90381-LBA8-C10	SCREW SPECIAL 6*20	SCREW SPECIAL 6*20	1	
	90677	90677-GAR1-C00	NUT CLIP 5MM	NUT CLIP 5MM	1	
	93404	93404-06012-08	BOLT WASHER 6*12	BOLT WASHER 6*12 (C)	4	
	93891	93891-05016-07	SCREW WASHER 5*16 (K)	SCREW WASHER 5*16 (K)	1	
	93903-34280	93903-34280	SCREW TAPPING 4*10 (K)	SCREW TAPPING 4*10 (K)	1	
	93903-34380	93903-34380	SCREW TAPPING 4*12	SCREW TAPPING 4*12	5	
	93903-45380	93903-45380	SCREW TAPPING 5*16(K)	SCREW TAPPING 5*16(K)	1	
	93903-GFY6	93903-GFY6-C00	SCREW TAPPING 4*14	SCREW TAPPING 4*14	1	
	94103	94103-LBA8-C10	WASHER SPECIAL	WASHER SPECIAL	1	
	95701	95701-06012-07	BOLT FLANGE 6*12(K)	BOLT FLANGE 6*12(K)	1	

F16

Air Cleaner

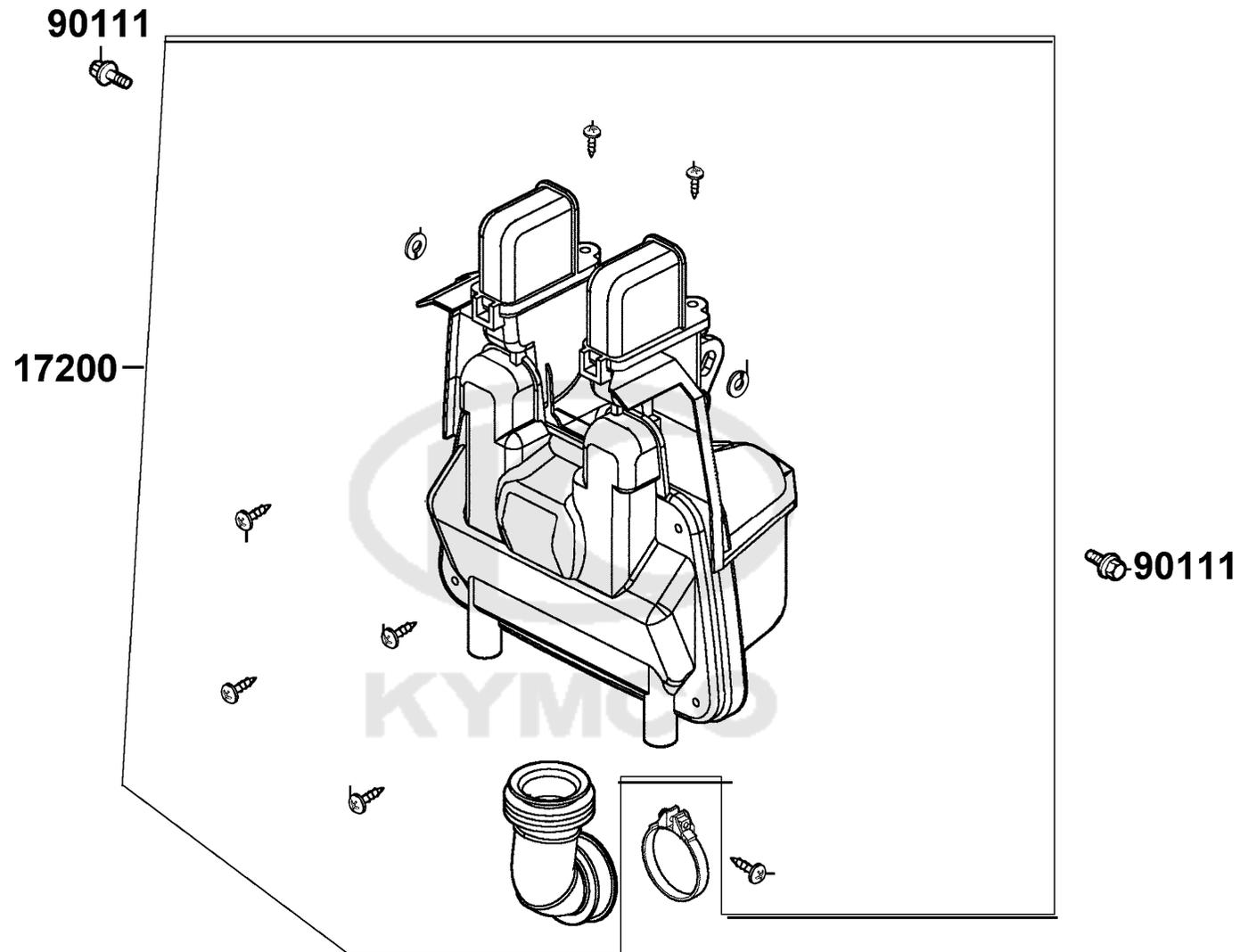

Sales mark	Ref no	Part no	Description	Reg description	Regd no	F16
------------	--------	---------	-------------	-----------------	---------	------------

17200	17200-LBA8-E00	17200-LBA8-E00	AIR/C ASSY	AIR/C ASSY	1	
90111	90111-KFW6-C00	90111-KFW6-C00	BOLT FLANGE 6MM	BOLT FLANGE 6MM	1	



F17

Muffler

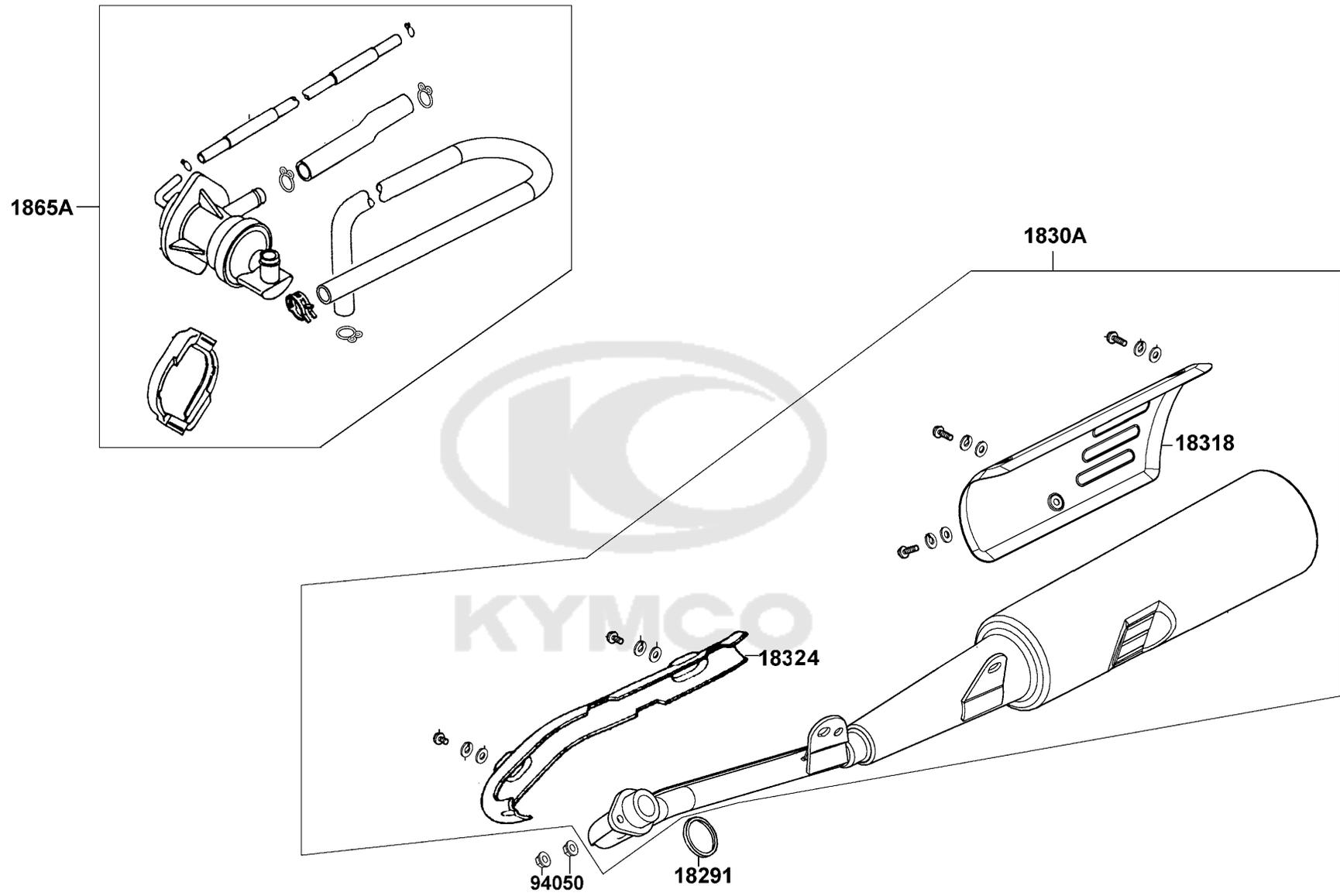

Sales mark	Ref no	Part no	Description	Reg description	Regd no	F17
	18291	18291-GHC8-C00	GASKET EXH PIPE	GASKET EXH PIPE	1	
	1830A	1830A-LBA8-E80	MUFFLER ASSY EXH	MUFFLER ASSY EXH	1	
	18318	18318-KGC4-E00	PROTECTOR MUFFLER COMP	PROTECTOR MUFFLER BODY	1	
	18324	18324-LBA8-C10	EXHAUST PIPE GUARD	EXHAUST PIPE GUARD	1	
	1865A	1865A-LBA8-E80	AIC/V SET	AIC/V SET	1	
	94050	94050-06080	NUT FLANGE 6MM	NUT FLANGE 6MM	2	
						

F18

Foot bar

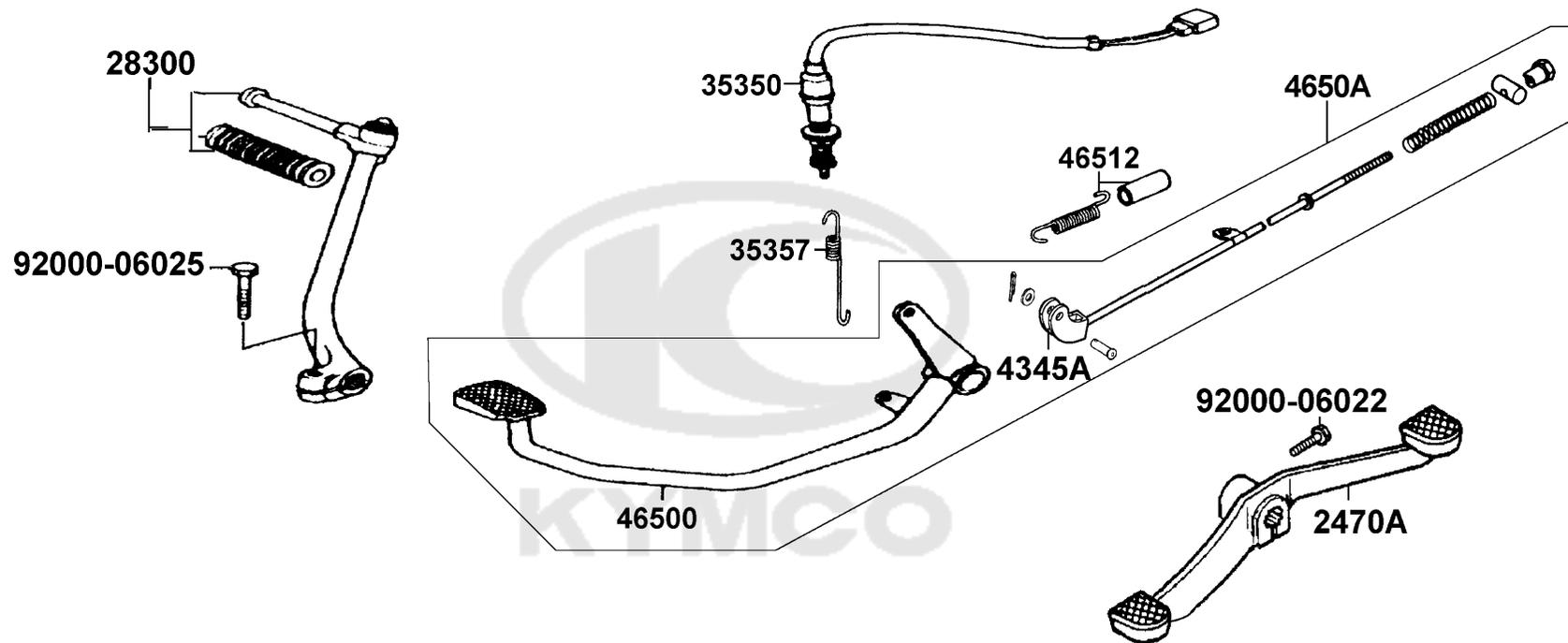

Sales mark	Ref no	Part no	Description	Reg description	Regd no	F18
2470A		2470A-LBA8-E30	PEDAL COMP CHANGE	PEDAL COMP CHANGE	1	
28300		28300-LBA8-C10	ARM ASSY KICK STARTER	ARM ASSY KICK STARTER	1	
35350		35350-KADA-C10	SW ASSY RR STOP	SW ASSY RR STOP	1	
35357		35357-LBA8-C10	SPG STOP SW	SPG STOP SW	1	
4345A		4345A-LBA8-E80	ROD ASSY RR BRK	ROD ASSY RR BRK	1	
46500		46500-LBA8-C10	PEDAL RR BRK	PEDAL RR BRK	1	
4650A		4650A-LBA8-E80	PEDAL ASSY RR BRK	PEDAL ASSY RR BRK	1	
46512		46512-LBA8-C10	SPG BRK PEDAL	SPG BRK PEDAL	1	
92000-06022		92000-06022-0H	BOLT HEX 6*22 (C)	BOLT HEX 6*22 (C)	1	
92000-06025		92000-06025-0H	BOLT HEX 6*25	BOLT HEX 6*25 (C)	1	

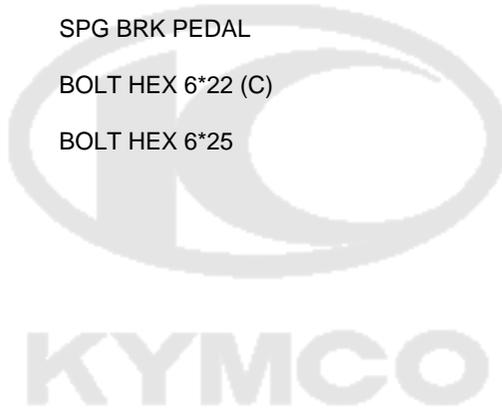

Sales mark	Ref no	Part no	Description	Reg description	Regd no	F19
50190		50190-LBA8-C10	BRKT R PILLION STEP	BRKT R PILLION STEP	1	
50191		50191-LBA8-C10	BRKT L PILLION STEP	BRKT L PILLION STEP	1	
5019A		5019A-LBA8-C10	STEP ASSY R PILLION	STEP ASSY R PILLION	1	
5019B		5019B-LBA8-C10	STEP ASSY L PILLION	STEP ASSY L PILLION	1	
50610		50610-LBA8-C10	BAR COMP STEP	BAR COMP STEP	1	
5061A		5061A-LBA8-C10	BAR ASSY FR STEP	BAR ASSY FR STEP	1	
50661		50661-LBA8-C10	RUBBER FR STEP	RUBBER FR STEP	1	
50662		50662-LBA8-C10	DAMPING MAT FR STEP COMP	DAMPING MAT FR STEP COMP	1	
50663		50663-LBA8-C10	COLLAR FR SYEP COMP	COLLAR FR SYEP COMP	1	
90304		90304-LBA8-C10	NUT U FLANGE 10MM (C)	NUT U FLANGE 10MM (C)	1	
94050-08800		94050-08800-08	NUT FLANGE 8MM(C)	NUT FLANGE 8MM(C)	1	
95701-08016		95701-08016-08	BOLT FLANGE 8*16 (C)	BOLT FLANGE 8*16 (C)	2	
95701-08025		95701-08025-08	BOLT FLANGE 8*25	BOLT FLANGE 8*25	3	
95701-08028		95701-08028-08	BOLT FLANGE 8*28 (C)	BOLT FLANGE 8*28 (C)	4	
95701-08030		95701-08030-08	BOLT FLANGE 8*30	BOLT FLANGE 8*30 (C)	1	

F20

Foot rest

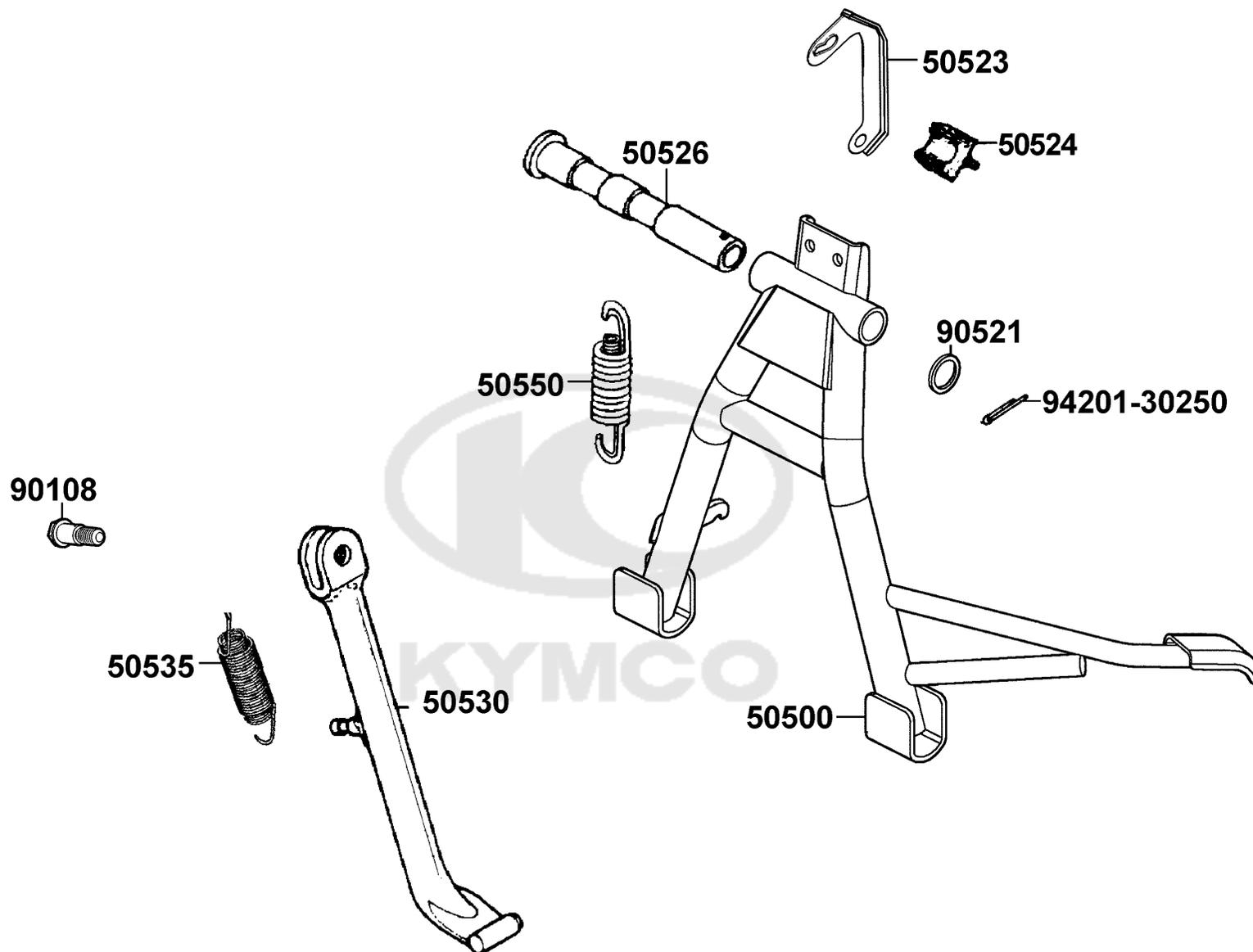

Sales mark	Ref no	Part no	Description	Reg description	Regd no	F20
50500		50500-LBA8-C10	STAND COMP MAIN	STAND COMP MAIN	1	
50523		50523-LBA8-C10	HOOK MAIN STAND	HOOK MAIN STAND	1	
50524		50524-LBA8-C10	RUBBER MAIN STAND	RUBBER MAIN STAND	1	
50526		50526-LBA8-C10	SHAFT MAIN STAND PIVOT	SHAFT MAIN STAND PIVOT	1	
50530		50530-LBA8-E80	SIDE STAND COMP	SIDE STAND COMP	1	
50535		50535-KKB1-E00	SPG A SIDE STAND	SPG A SIDE STAND	1	
50550		50550-KEB7-C00	SPG MAIN STAND COMP	SPG MAIN STAND COMP	1	
90108		90108-KUDU-900	SCREW SIDE STAND PIVOT	SIDE STAND PIVOT	1	
90521		90521-0H28-C00	DIA WASHER 17*22*1.6 C	DIA WASHER 17*22*1.6 C	1	
94201		94201-30250	PIN SPLIT 3*25	PIN SPLIT 3*25	1	



F21

Latter forks

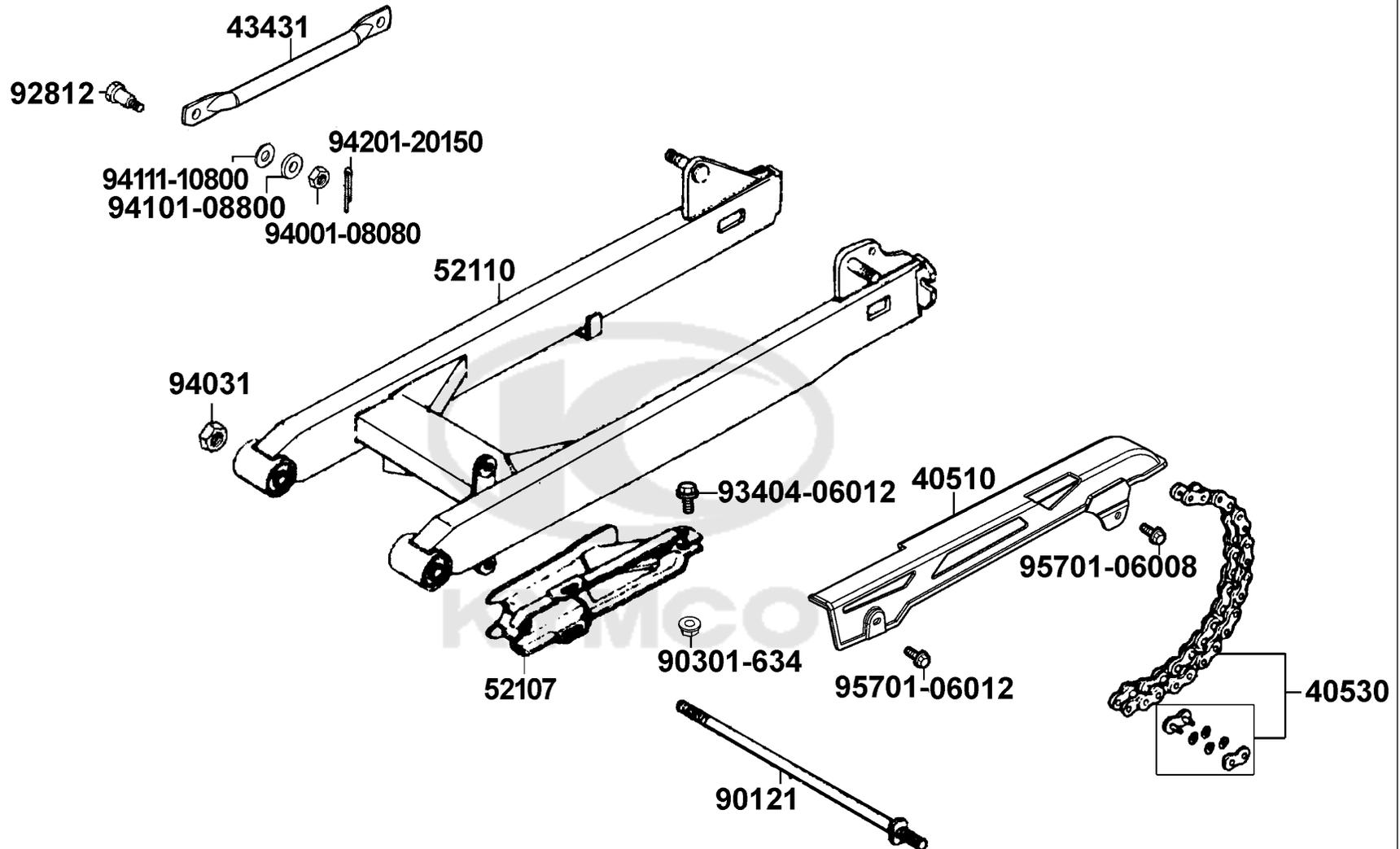

Sales mark	Ref no	Part no	Description	Reg description	Regd no	F21
	40510	40510-LBA8-E80	CASE DRIVE CHAIN	CASE DRIVE CHAIN	1	
	40530	40530-LBA8-E80	DRIVE CHAIN 428HG-108	DRIVE CHAIN 428HG-108	1	
	43431	43431-LBA8-E000	ARM RR STPR	ARM RR STPR	1	
	52107	52107-LBA8-C10	SLIDER CHAIN	SLIDER CHAIN	1	
**	52110	52110-LBA8-E80	FORK COMP RR	FORK COMP RR	1	
	90121	90121-LBA8-C10	BOLT RR FORK PIVOT	BOLT RR FORK PIVOT	1	
	90301	90301-6D34-C00	NUT FLANGE 6MM	NUT FLANGE 6MM	1	
	92812	92812-10000	BOLT RR BRAKE STPR ARM	BOLT RR BRAKE STPR ARM	1	
	93404	93404-06012-08	BOLT WASHER 6*12	BOLT WASHER 6*12 (C)	1	
	94001	94001-08080-0S	NUT HEX 8MM	NUT HEX 8MM (C)	1	
	94031	94031-LBA8-C10	NUT HEX 10MM	NUT HEX 10MM	1	
	94101	94101-08800	WASHER PLAIN 8MM	WASHER PLAIN 8MM (C)	1	
	94111	94111-10800	WASHER SPG 10MM	WASHER SPG 10MM (C)	1	
	94201	94201-20150	PIN SPLIT 2*15	PIN SPLIT 2* 15	1	
	95701-06008	95701-06008-08	BOLT FLANGE 6*8	BOLT FLANGE 6*8 (C)	1	
	95701-06012	95701-06012-08	BOLT FLANGE 6*12	BOLT FLANGE 6*12	1	

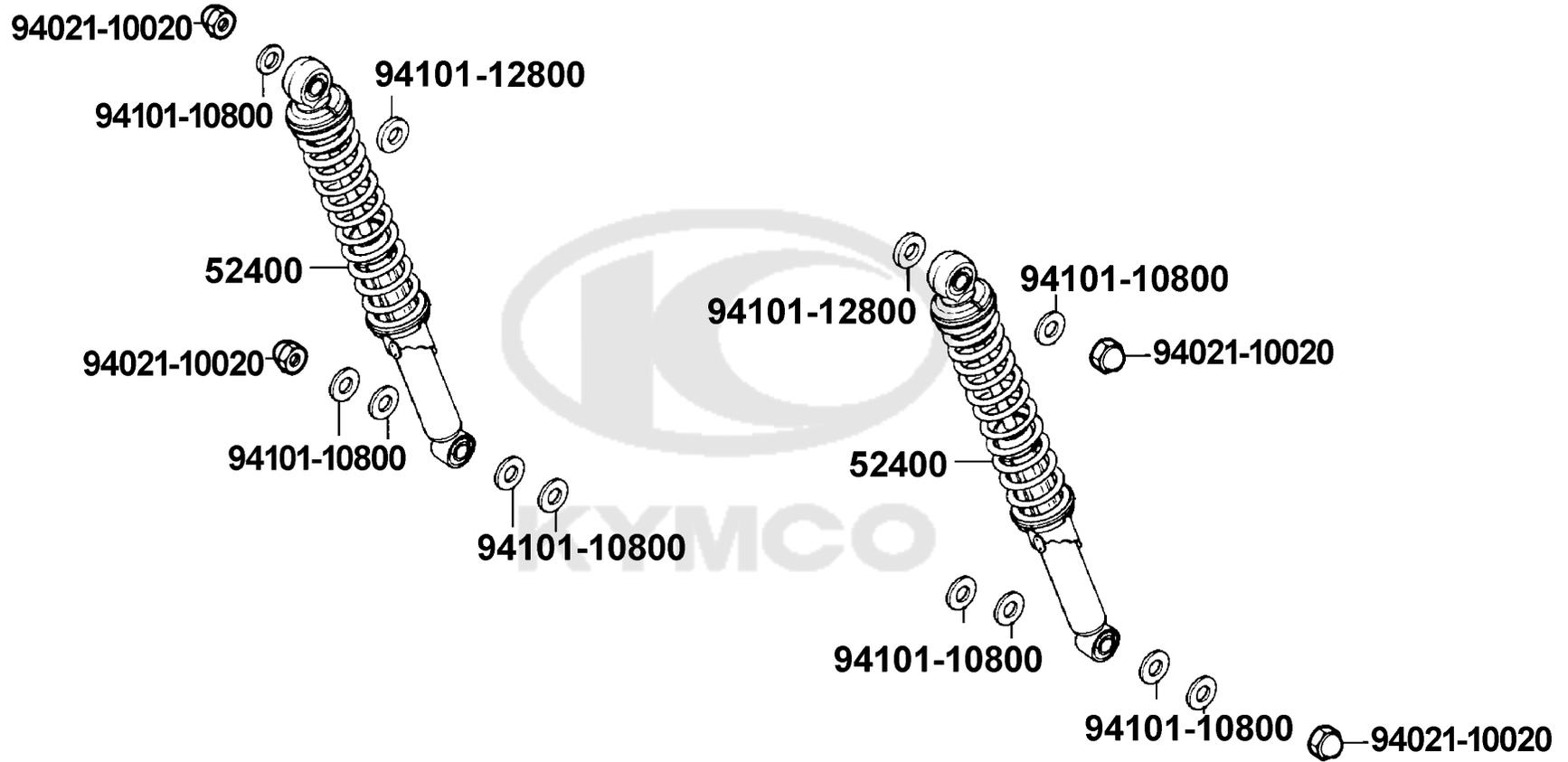

Sales mark	Ref no	Part no	Description	Reg description	Regd no	F22
------------	--------	---------	-------------	-----------------	---------	------------

52400		52400-LBA8-E80	CUSHION ASSY RR	CUSHION ASSY RR	1	
94021		94021-10020-0S	NUT HEX CAP 10MM	NUT HEX CAP 10MM (Cr)	4	
94101		94101-10800	WASHER PLAIN 10MM	WASHER PLAIN 10MM	10	



F23

Rear Fender

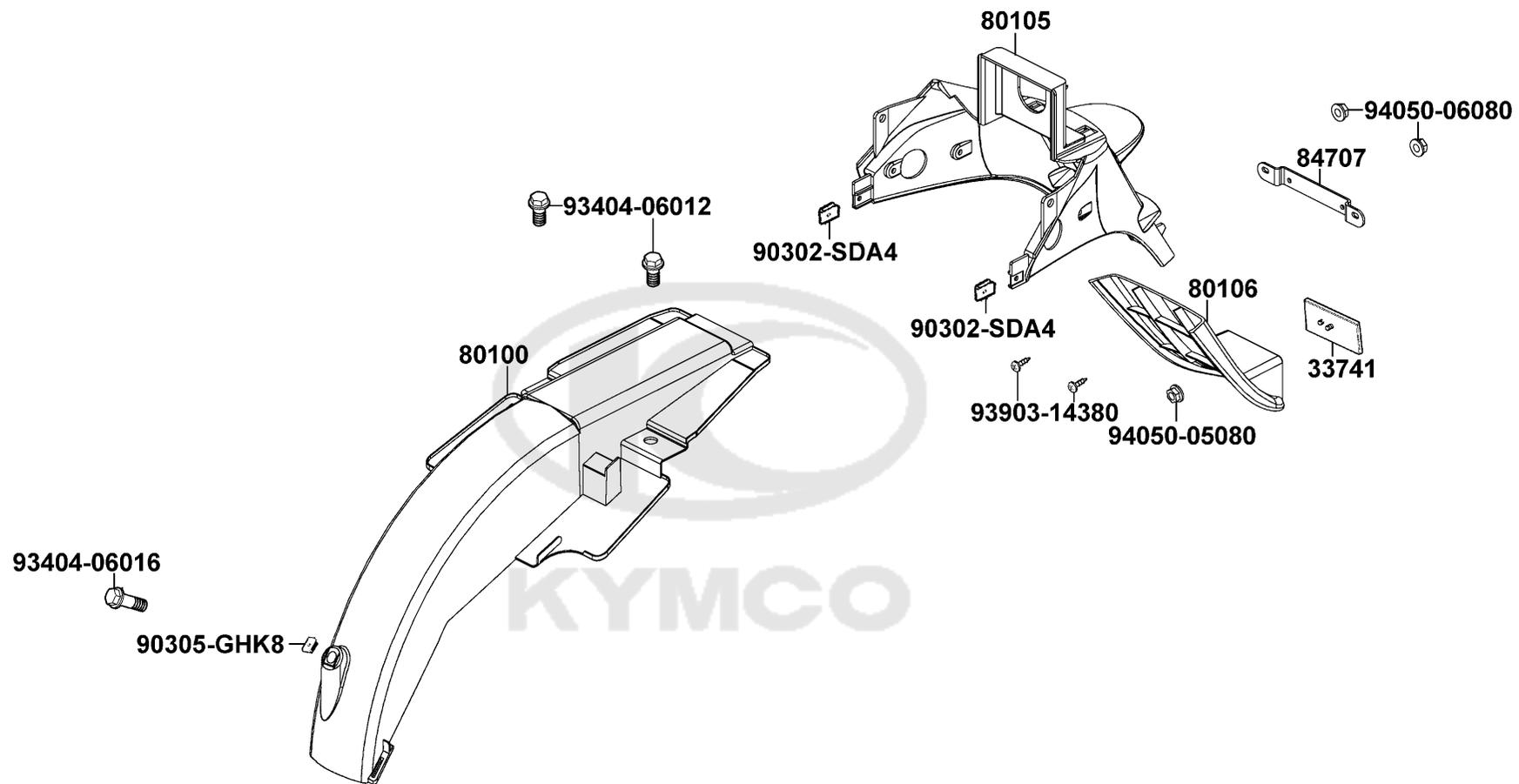

Sales mark	Ref no	Part no	Description	Reg description	Regd no	F23
	33741	33741-KGB4-C00	REFLEX REFLECTOR	REFLEX REFLECTOR	1	
	80100	80100-LBA8-C10	FENDER RR INNER	FENDER RR INNER	1	
**	80105	80105-LBA8-C10	FENDER RR A	FENDER RR A	1	
**	80106	80106-LBA8-C10	FENDER RR B	FENDER RR B	1	
	84707	84707-KGB4-C10	UNDER NUMBER BRKT	UNDER NUMBER BRKT	1	
	90302-SDA4	90302-SDA4-C00	NUT SPRING 4MM	NUT SPRING 4MM	1	
	90305-GHK8	90305-GHK8-C00	NUT CLIP 6MM	NUT CLIP 6MM	1	
	93404-06012	93404-06012-08	BOLT WASHER 6*12	BOLT WASHER 6*12 (C)	2	
	93404-06016	93404-06016-08	BOLT WASHER 6*16	BOLT WASHER 6*16 (C)	1	
	93903	93903-14380	SCREW TAPPING 4*12 (K)	SCREW TAPPING 4*12 (K)	2	
	94050-05080	94050-05080	NUT FLANGE 5MM	NUT FLANGE 5MM	1	
	94050-06080	94050-06080	NUT FLANGE 6MM	NUT FLANGE 6MM	1	

F24

Winker Tail Light

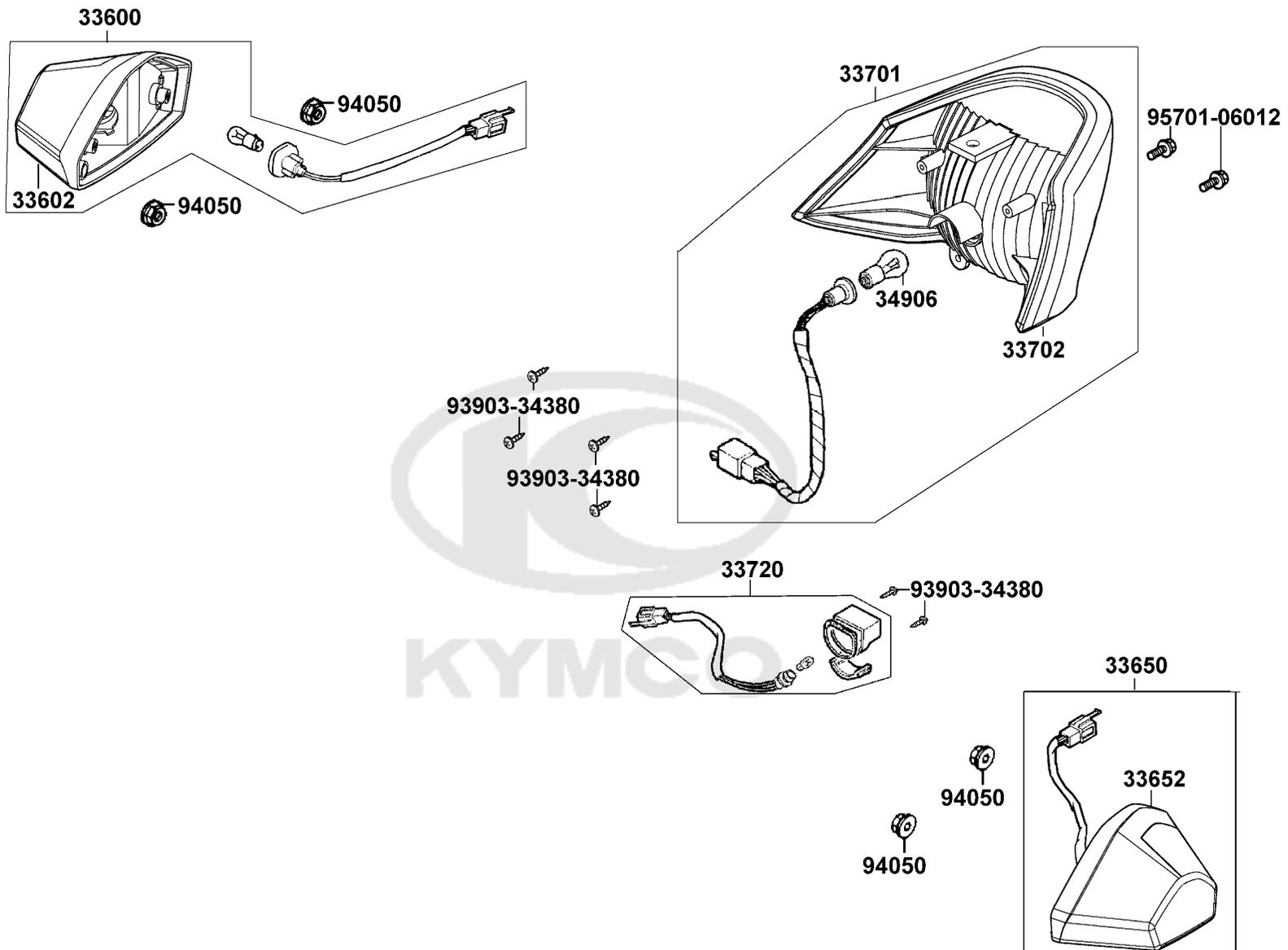

Sales mark	Ref no	Part no	Description	Reg description	Regd no	F24
	33600	33600-LBA8-E80	WINKER ASSY R RR	WINKER ASSY R RR	1	
	33602	33602-LBA8-C10	LENS R RR WINKER	LENS R RR WINKER	1	
	33650	33650-LBA8-E80	WINKER ASSY L RR	WINKER ASSY L RR	1	
	33652	33652-LBA8-C10	LENS L RR WINKER	LENS L RR WINKER	1	
	33701	33701-LBA8-E80	IGHT ASSY RR COMP	IGHT ASSY RR COMP	1	
	33702	33702-LBA8-C10	LENS TAIL LIGHT	LENS TAIL LIGHT	1	
	33720	33720-LBA8-C10	LIGHT ASSY LICENCE	LIGHT ASSY LICENCE	1	
	34906-LBA8	34906-LBA8-E80	BULB TAIL & STOP	BULB TAIL & STOP	1	
	93903-34380	93903-34380	SCREW TAPPING 4*12	SCREW TAPPING 4*12	2	
	94050	94050-06080	NUT FLANGE 6MM	NUT FLANGE 6MM	4	
	95701	95701-06012-08	BOLT FLANGE 6*12	BOLT FLANGE 6*12	2	



F25

Battery

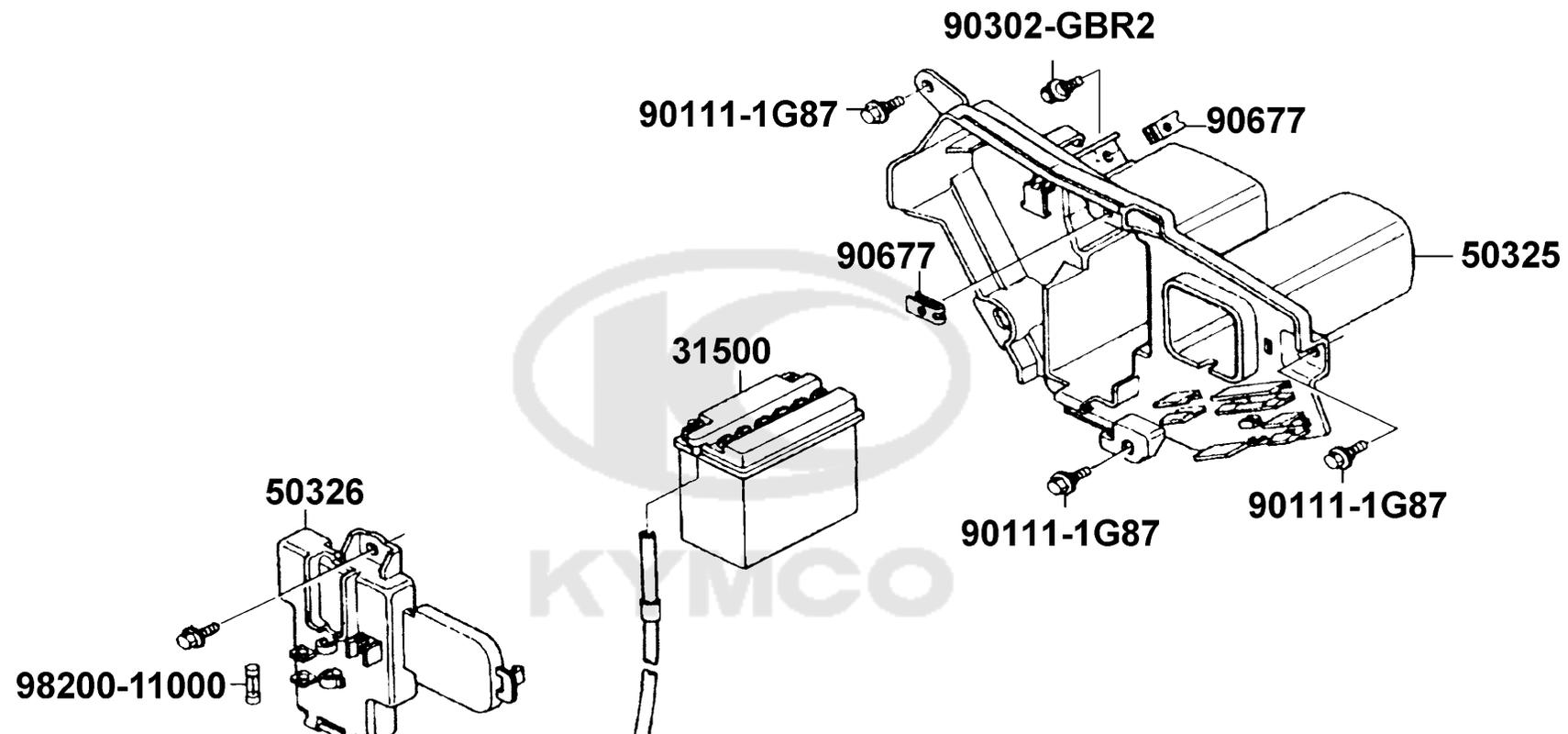

Sales mark	Ref no	Part no	Description	Reg description	Regd no	F25
	31500	31500-LBA8-E80	BATTER CB5L-B	BATTER CB5L-B	1	
**	50325	50325-LBA8-C10	CASE BATTERY	CASE BATTERY	1	
**	50326	50326-LBA8-C10	COVER BATTERY	COVER BATTERY	1	
	90111	90111-1G87-C00	BOLT FLANGE 6MM	BOLT FLANGE 6MM	1	
	90302	90302-GBR2-C00	BOLT-WASH 5*12	BOLT-WASH 5*12	1	
	90677	90677-GAR1-C00	NUT CLIP 5MM	NUT CLIP 5MM	1	
	98200	98200-11000	FUSE 10A	FUSE A10	1	



F26

Harness Wire

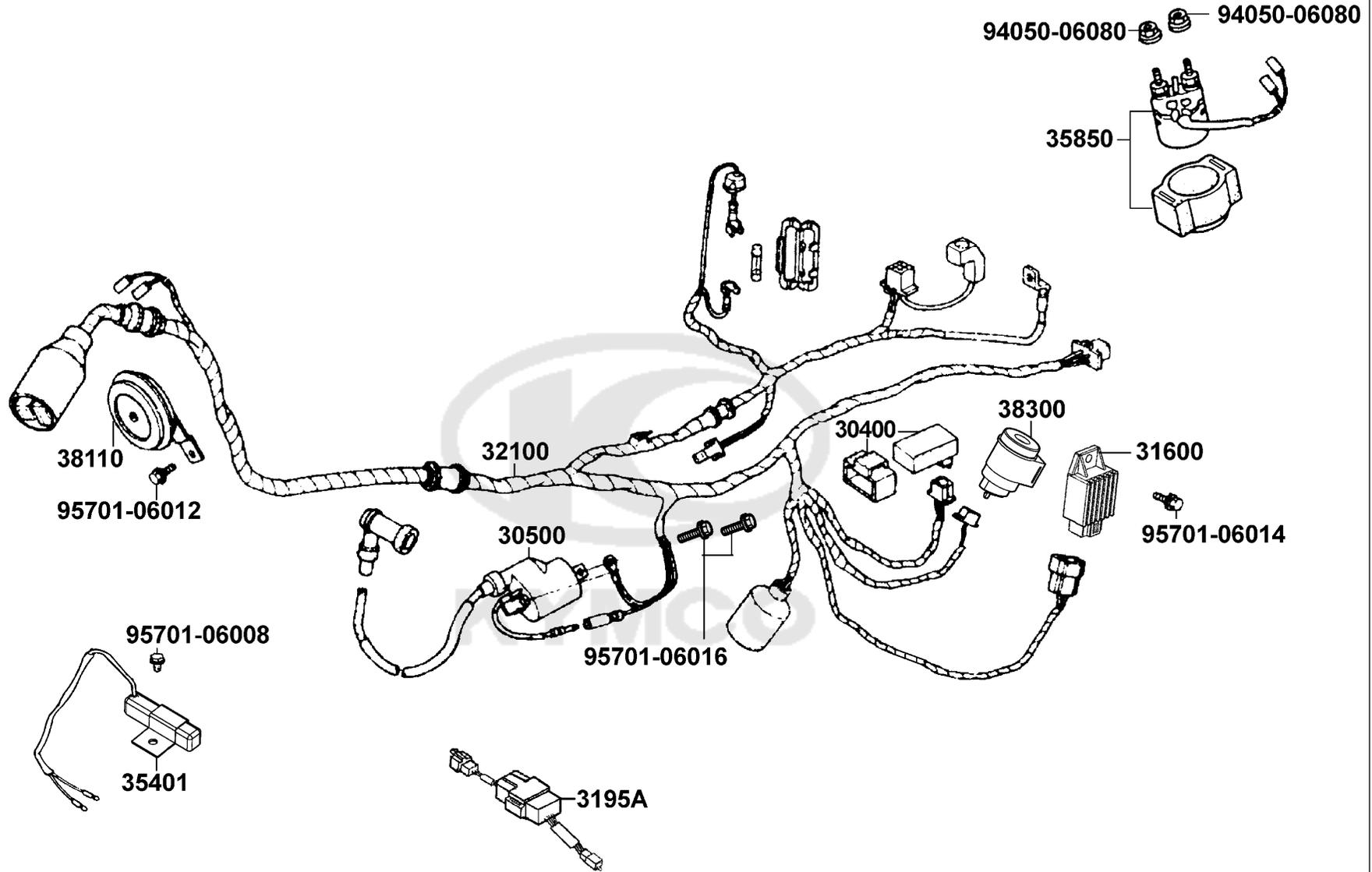

Sales mark	Ref no	Part no	Description	Reg description	Regd no	F26
30400		30400-LBA8-C10	UNIT ASSY CDI	UNIT ASSY CDI	1	
30500		30500-LBA8-C10	COIL ASSY IGN	COIL ASSY IGN	1	
31600		31600-KDU-9000	REG REC COMP(AC)	REG REC COMP(AC)	1	
3195A		3195A-LBB9-B50	HAZARD CONTROL ASSY	HAZARD CONTROL ASSY	1	
32100		32100-LBA8-E81	HARNES WIRE	HARNES WIRE	1	
35401		35401-GAR1-C00	RESISTOR COMP B	RESISTOR COMP B	1	
35850		35850-LBA8-C10	RELAY ASSY START	RELAY ASSY START	1	
38110		38110-LBA8-E0B	HORN COMP	HORN COMP	1	
38300		38300-GLW0-C00	RELAY ASSY WINKERF	RELAY ASSY WINKERF	1	
94050		94050-06080	NUT FLANGE 6MM	NUT FLANGE 6MM	2	
95701-06008		95701-06008-08	BOLT FLANGE 6*8	BOLT FLANGE 6*8 (C)	1	
95701-06012		95701-06012-08	BOLT FLANGE 6*12	BOLT FLANGE 6*12	1	
95701-06014		95701-06014-08	BOLT FLANGE 6*14	BOLT FLANGE 6*14	1	
95701-06016		95701-06016-08	BOLT FLANGE 6*16	BOLT FLANGE 6*16	2	

F27

Frame Body

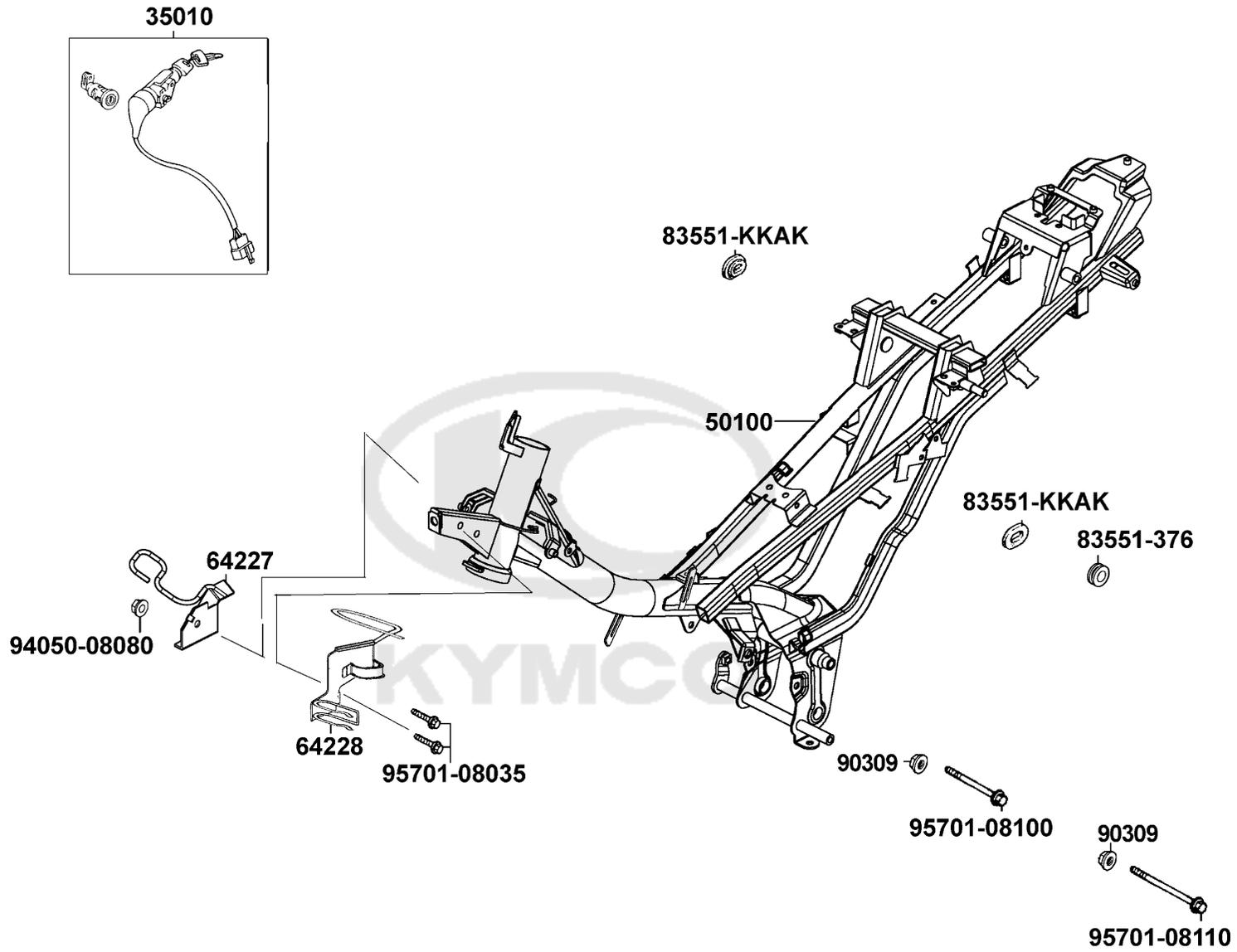

Sales mark	Ref no	Part no	Description	Reg description	Regd no	F27
35010		35010-LBA8-C10	KEY SET	KEY SET	1	
50100		50100-LBA8-E80	BODY COMP FRAME	BODY COMP FRAME	1	
64227		64227-LBA8-C10	STAY HORN	STAY HORN	1	
64228		64228-LBA8-C10	STAY HANESS WIRE	STAY HANESS WIRE	1	
83551-376		83551-3F76-C00	GROMMET SIDE COVER	GROMMET SIDE COVER	1	
83551-KKAK		83551-KKAK-C00	GROMMET AIR CLEANER C	GROMMET AIR CLEANER C	1	
90309		90309-GLW0-C00	NUT U FLANGE 8MM (C)	NUT U FLANGE 8MM (C)	1	
94050		94050-08080	NUT FLANGE 8MM	NUT FLANGE 8MM	1	
95701		95701-08035-08	BOLT FLANGE 8*35	BOLT FLANGE 8*35 (C)	2	

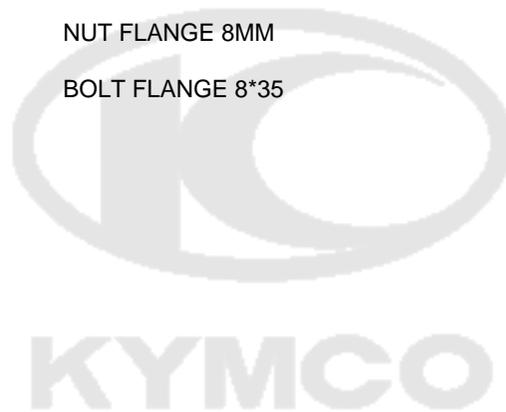



87552

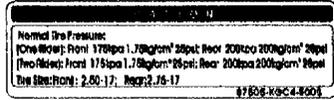

87505

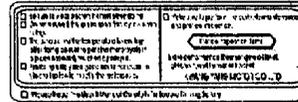

87560

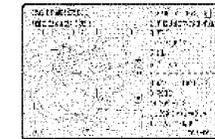

87224



86121



86131



86423



86433



86404



86443

86453

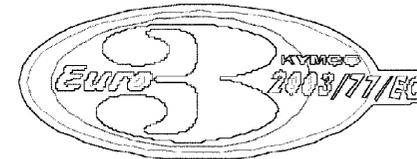

87311

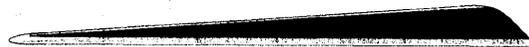

86323



86333

Sales mark	Ref no	Part no	Description	Reg description	Regd no	F28
**	86121	86121-LBA8-E80	STRIPE R FR COVER	STRIPE R FR COVER	1	
**	86131	86131-LBA8-E80	STRIPE L FR COVER	STRIPE L FR COVER	1	
**	86323	86323-LBA8-E80	STRIPE R SIDE COVER	STRIPE R SIDE COVER	1	
**	86333	86333-LBA8-E80	STRIPE L SIDE COVER	STRIPE L SIDE COVER	1	
**	86404	86404-LBA8-E80	EMB ACTIVE 110	EMB ACTIVE 110	1	
**	86423	86423-LBA8-E80	STRIPE R BODY COVER	STRIPE R BODY COVER	1	
**	86433	86433-LBA8-E80	STRIPE L BODY COVER	STRIPE L BODY COVER	1	
**	86443	86443-LBA8-E80	STRIPE B R BODY COVER	STRIPE B R BODY COVER	1	
**	86453	86453-LBA8-E80	STRIPE B L BODY COVER	STRIPE B L BODY COVER	1	
**	87224	87224-LBA8-E80	CAUTION ANTI-TAMPERING	CAUTION ANTI-TAMPERING	1	
**	87311	87311-KKD6-E00	STRIPE MARK EURO 2	STRIPE MARK EUR02	1	
**	87505	87505-KGC4-C10	LABEL TIPE	LABEL TIPE	1	
**	87552	87552-KQCQ-C00	MARK KYMCO	MARK KYMCO	1	
**	87560	87560-GFY6-C01	MARK DRIVE CAUTION	MARK DRIVE CAUTION	1	

PART NO. INDEX

PART NO.	VERSION	PAGE	PART NO.	VERSION	PAGE	PART NO.	VERSION	PAGE
11000			12391-LBA8-C10	0	E01	14566-LBA8-C10	0	E04
11100-LBA8-C10	1	E14	12394-LBA8-C10	0	E01	14610-KGC4-C00	0	E04
11191-LBA8-C10	0	E14	12395-LBA8-C10	0	E01	14615-LBA8-C10	0	E04
11200-LBA8-C000	2	E14	12440-LBA8-C10	0	E01	14670-KGB4-C10	0	E04
11207-LBA8-C10	0	E12	13000			14675-LBA8-C10	0	E04
11330-LBA8-C10	0	E06	13000-LBA8-C10	0	E15	14711-LBA8-C10	0	E02
11336-LBA8-C10	0	E06	13011-LBA8-C10	0	E15	14721-LBA8-C10	0	E02
11341-LBA8-C10	3	E10	13101-LBA8-C10	0	E15	14751-LBA8-C10	1	E02
11361-LBA8-C000	0	E10	13111-LBA8-C10	1	E15	14761-LBA8-C10	1	E02
11384-LBA8-C10	0	E14	13115-0A01-C00	2	E15	14771-GDB4-C00	2	E02
11393-LBA8-C10	0	E06	14000			14775-MFA6-C00	2	E02
11395-LBA8-C10	0	E10	14100-LBA8-C10	0	E03	14781-LBA8-C10	0	E02
12000			14160-LBA8-C10	0	E03	15000		
12100-LBA8-C000	0	E05	14321-LBA8-C10	0	E04	15100-LBA8-C10	0	E09
12191-LBA8-C10	0	E05	14401-LBA8-C10	0	E04	15119-LBA8-C10	0	E09
12200-LBA8-C10	1	E02	1441A-LBA8-C10	0	E03	15384-LBA8-C10	0	E09
12209-GDB4-C00	1	E02	14431-LBA8-C10	0	E03	15421-LBA8-C10	0	E09
1220A-LBA8-C10	0	E02	14451-LBA8-C10	0	E03	15439-LBA8-C11	0	E07
12251-LBA8-C11	1	E02	14500-LBA8-C10	0	E04	15441-LBA8-C10	0	E07
12301-LBA8-C000-CK	0	E01	14502-0F86-C00	0	E04	15651-LBA8-C10	0	E06
12340-LBA8-E000	0	E01	14541-LBA8-C10	0	E04	15760-LBA8-C10	0	E14
12361-0E35-E80	0	E01	14550-LBA8-C10	0	E04			

PART NO. INDEX

PART NO.	VERSION	PAGE	PART NO.	VERSION	PAGE	PART NO.	VERSION	PAGE
16000			18000			22631-LBA8-C10	0	E07
1610K-LBA8-C10	0	E19	18291-GHC8-C00	0	F17	22641-LBA8-C10	0	E07
16211-LBA8-C10	0	E02	1830A-LBA8-E80	0	F17	22651-LBA8-C10	0	E07
1691A-GFY6-C00	0	F13	18318-KGC4-E00	1	F17	22660-LBA8-C10	0	E07
16956-LBA8-C10	0	F13	18324-LBA8-C10	0	F17	2266A-LBA8-C10	0	E07
17000			1865A-LBA8-E80	0	F17	22810-LBA8-C10	0	E06
17110-LBA8-E80	0	E02	22000			22820-LBA8-C10	0	E06
17111-LBA8-C10	0	E02	22011-LBA8-C10	0	E07	2283A-LBA8-C10	0	E06
17200-LBA8-E00	0	F16	22012-LBA8-C10	0	E07	22846-LBA8-C10	0	E06
17248-LBA8-C00	0	F15	22100-LBA8-C10	0	E08	23000		
17249-LBA8-C10	0	F15	2210A-LBA8-C10	0	E08	23211-LBA8-C10	0	E16
17500-LBA8-C10	3	F13	22121-LBA8-C10	0	E08	23216-LBA8-C10	0	E08
17508-LBA8-C10	1	F13	22131-LBA8-C10	0	E08	23217-LBA8-C10	0	E08
17509-LBA8-C10	1	F13	22201-LBA8-C10	0	E08	2321A-LBA8-C10	0	E16
17620-LBA8-C10	0	F13	22203-LBA8-C10	0	E08	23221-LBA8-C10	0	E16
17682-LBA8-C10	0	F13	22311-1G07-C00	0	E08	23224-LBA8-C10	0	E07
17910-LBA8-C10	3	F03	22350-LBA8-C10	0	E08	23225-LBA8-C10	0	E17
17950-LBA8-C10	0	F03	22361-LBA8-C10	0	E08	2322A-LBA8-C10	0	E16
17951-LBA8-C10	0	F03	22401-LBA8-C10	0	E08	23230-LBA8-C10	0	E07
17952-LBA8-C10	0	F03	2260A-LBA8-C10	0	E07	23426-LBA8-C10	0	E16
			22610-LBA8-C10	0	E07	23427-LBA8-C10	0	E16
			22614-LBA8-C10	0	E07	23441-LBA8-C10	0	E16
						23443-LBA8-C10	0	E16
						23444-LBA8-C10	0	E16

PART NO. INDEX

PART NO.	VERSION	PAGE	PART NO.	VERSION	PAGE	PART NO.	VERSION	PAGE
23445-LBA8-C10	0	E16						
23451-LBA8-C10	0	E16	28000			31000		
23461-LBA8-C10	0	E16						
23471-LBA8-C10	0	E16	28101-LBA8-C10	0	E12	31100-LBA8-E000	1	E11
23481-LBA8-C10	0	E16	28102-LBA8-C10	0	E12	3111A-LBA8-C10	0	E11
23491-LBA8-C10	0	E16	28103-KGB4-C10	0	E12	31120-LBA8-E80	0	E11
23801-LBA8-C10	0	E16	28110-LBA8-C10	0	E12	31200-LBA8-C10	2	E13
23811-LBA8-C10	0	E16	2811A-LBA8-C10	0	E12	31500-LBA8-E80	0	F25
			28120-LBA8-C10	0	E12	31600-KDU-9000	0	F26
24000			28125-3C23-C00	0	E12	3195A-LBB9-B50	0	F26
			28126-LBA8-C10	0	E12			
24221-LBA8-C10	0	E17	28211-LBA8-C10	1	E18	32000		
24301-LBA8-C10	0	E17	28221-LBA8-C10	0	E18			
2430A-LBA8-C10	0	E17	28225-LBA8-C10	0	E18	32100-LBA8-E81	2	F26
24411-3D24-C00	0	E17	28251-LBA8-C10	0	E18	32906-LBA8-C10	0	E06
24431-LBA8-C10	0	E17	2825A-LBA8-C10	1	E18	32962-LBA8-C10	0	E10
24435-LBA8-C10	0	E17	28261-LBA8-C10	0	E18			
24610-LBA8-C10	0	E17	28282-LBA8-C10	0	E18	33000		
2461A-LBA8-C10	0	E17	28300-LBA8-C10	1	F18			
24621-1G07-C00	0	E17				33100-LBA8-E80	0	F01
24631-1G07-C00	0	E17	30000			33600-LBA8-E80	0	F24
24651-LBA8-C10	0	E17				33602-LBA8-C10	0	F24
2470A-LBA8-E30	0	F18	30400-LBA8-C10	1	F26	33650-LBA8-E80	2	F24
			30500-LBA8-C10	2	F26	33652-LBA8-C10	0	F24
						33701-LBA8-E80	0	F24
						33702-LBA8-C10	0	F24

PART NO. INDEX

PART NO.	VERSION	PAGE	PART NO.	VERSION	PAGE	PART NO.	VERSION	PAGE
33720-LBA8-C10	1	F24	37802-LBA8-C10	0	F13	42620-LBA8-C11	1	F12
33741-GFY6-C00	0	F07	3780A-LBA8-C10	0	F13	42625-LBA8-C11	5	F12
33741-KGB4-C00	2	F23				42710-LBA8-C10	2	F12
34000			38000			43000		
34906-LBA8-E80	1	F24	38110-LBA8-E0B	1	F26	43000-LBA8-E80	0	F11
35000			38300-GLW0-C00	0	F26	43431-LBA8-E000	0	F21
35010-LBA8-C10	0	F27	40000			43434-2F86-C00	0	F11
35150-GFY6-C00	1	F03	40510-LBA8-E80	1	F21	4345A-LBA8-E80	2	F18
35160-GFY6-C00	1	F03	40530-LBA8-E80	1	F21	44000		
35170-KNBN-C00	1	F03	4054A-LBA8-C10	2	F11	44301-KFW6-C00	0	F11
35180-GFY6-C00	2	F03	41000			44301-LBA8-C11	0	F10
35190-GFY6-C00	0	F03	41201-LBA8-C10	3	F12	44311-LBA8-C11	5	F10
35200-GFY6-C00	1	F03	41241-LBA8-C10	1	F12	44600-LBA8-E81	6	F10
35350-KADA-C10	0	F18	42000			44601-LBA8-C11	0	F10
35357-LBA8-C10	0	F18	42311-LBA8-C11	4	F11	44620-LBA8-C11	2	F10
35401-GAR1-C00	0	F26	42313-LBA8-C11	5	F12	44680-LBA8-C11	3	F10
35750-LBA8-C10	1	E17	42600-LBA8-C11	0	F12	44710-LBA8-E81	2	F10
35850-LBA8-C10	2	F26	42601-LBA8-C11	3	F12	44800-LBA8-C11	3	F10
37000			42610-LFD6-C50	0	F12	44830-LBA8-C10	0	F02
37200-LBA8-E80	0	F02						

PART NO. INDEX

PART NO.	VERSION	PAGE	PART NO.	VERSION	PAGE	PART NO.	VERSION	PAGE		
45000			50301-LBA8-C10	3	F06	52110-LBA8-E80	6	F21		
			50302-LBA8-C10	3	F06	52400-LBA8-E80	2	F22		
			50306-LBA8-C10	2	F06	53000				
	45105-LBA8-305	0	F09	50325-LBA8-C10	0		F25			
	45121-LBA8-C11	1	F10	50326-LBA8-C10	0		F25			
	45126-LBA8-E80	0	F04	50500-LBA8-C10	0		F20	5310A-LBA8-C10	0	F05
	45127-LBA8-C11	0	F04	50523-LBA8-C10	2		F20	53125-GEN5-C00	1	F05
	45156-LBA8-C11	0	F04	50524-LBA8-C10	0		F20	53140-KHC4-C00	0	F03
	45200-LBA8-C10	0	F09	50526-LBA8-C10	0		F20	53166-KFA1-C00	0	F03
	45500-LBA8-E80	0	F04	50530-LBA8-E80	0		F20	53167-GBN2-C00	1	F03
			50535-KKB1-E00	1	F20		53168-GBN2-C00	1	F03	
			50550-KEB7-C00	0	F20		53175-LBA8-C11	0	F04	
46000			50610-LBA8-C10	6	F19	53200-LBA8-C11	0	F06		
	46500-LBA8-C10	2	F18	5061A-LBA8-C10	1	F19	53205-LBA8-305	0	F05	
	4650A-LBA8-E80	3	F18	50661-LBA8-C10	0	F19	53205-LBA8-C10	0	F05	
	46512-LBA8-C10	3	F18	50662-LBA8-C10	1	F19	53206-LBA8-C10	0	F05	
				50663-LBA8-C10	2	F19	53211-LBA8-C10	2	F06	
				51000			53212-LBA8-C10	2	F06	
								53214-LBA8-C10	2	F06
								53215-LBA8-C10	2	F06
								53220-LBA8-C10	2	F06
								61000		
50000						61100-LBA8-900	0	F07		
	50100-LBA8-E80	0	F27			61101-LBA8-900	0	F07		
	50190-LBA8-C10	1	F19	5140A-LBA8-E81	0	F08				
	50191-LBA8-C10	1	F19	5150A-LBA8-E81	0	F08				
	50192-LBA8-C10	1	F19	52000						
	50193-LBA8-C10	1	F19							
	5019A-LBA8-C10	0	F19							
	5019B-LBA8-C10	0	F19		52107-LBA8-C10	1	F21			

PART NO. INDEX

PART NO.	VERSION	PAGE	PART NO.	VERSION	PAGE	PART NO.	VERSION	PAGE
64000			80151-LBA8-C10	0	F15	84000		
64114-LBA8-C10	4	F07	80152-LBA8-C10	2	F15	84707-KGB4-C10	0	F23
64227-LBA8-C10	0	F27	80155-LBA8-C10	2	F15	86000		
64228-LBA8-C10	0	F27	81000			86121-LBA8-E80	0	F28
64301-LBA8-306	0	F15	81131-LBA8-C10	0	F15	86131-LBA8-E80	0	F28
64301-LBA8-307	0	F15	81201-LBA8-C10	0	F14	86323-LBA8-E80	0	F28
64301-LBA8-C10	0	F15	8120A-LBA8-E80	0	F14	86333-LBA8-E80	0	F28
75000			81250-LBA8-C10	2	F15	86404-LBA8-E80	0	F28
75581-6C73-C00	1	F14	83000			86423-LBA8-E80	0	F28
77000			83500-LBA8-306	0	F15	86433-LBA8-E80	0	F28
77200-LBA8-E80	0	F14	83500-LBA8-C10	0	F15	86443-LBA8-E80	0	F28
77232-LLC5-C10	0	F14	83510-LBA8-307	0	F15	86453-LBA8-E80	0	F28
77235-LBA8-C10	1	F14	83510-LBA8-307	1	F15	87000		
77240-GGS7-C11	0	F14	83510-LBA8-C10	1	F15	87224-LBA8-E80	1	F28
80000			83551-3F76-C00	0	F27	87311-KKD6-E00	0	F28
80100-LBA8-C10	0	F23	83551-KKAK-C00	0	F27	87505-KGC4-C10	1	F28
80105-LBA8-C10	0	F23	83600-LBA8-306	0	F15	87552-KQCQ-C00	4	F28
80106-LBA8-C10	0	F23	83600-LBA8-C10	0	F15	87560-GFY6-C01	3	F28
			83610-LBA8-307	0	F15			
			83610-LBA8-C10	0	F15			
			83650-LBA8-C000	0	F15			
			83750-LBA8-C10	0	F15			

PART NO. INDEX

PART NO.	VERSION	PAGE	PART NO.	VERSION	PAGE	PART NO.	VERSION	PAGE
88000			90122-KGD4-C11	0	F09	90442-GFF6-C00	0	E01
			90127-LBA8-C10	2	F11	90442-LBA8-C10	0	E07
			90145-9A61-C00	1	F04	90444-LBA8-C10	0	E08
88110-LBA8-E80	0	F03	90201-GFF6-011	0	E01	90452-LBA8-C10	0	E16
88120-LBA8-E80	0	F03	90206-0A01-001	2	E03	90454-1G07-C00	1	E18
89000			90231-0G87-C00	0	E08	90454-LBA8-C10	0	E16
			90231-GKT9-C00	0	E07	90455-LBA8-C10	0	E16
			90301-6D34-C00	0	F07	90464-LBA8-C10	0	E16
89010-KGB4-C00	0	F15	90301-6D34-C00	0	F21	90481-GGS7-C00	0	E01
90000			90301-LBA8-C10	2	F06	90481-LBA8-C10	0	E05
			90302-GBR2-C00	4	F25	90501-LBA8-C10	0	E05
			90302-KNBN-C00	1	F05	90502-LBA8-C10	0	E05
90012-3C33-C00	1	E03	90302-SDA4-C00	2	F05	90521-0H28-C00	0	F20
90031-LBA8-C10	0	E14	90302-SDA4-C00	2	F15	90522-LBA8-C10	3	F12
90032-LBA8-C10	0	E14	90302-SDA4-C00	2	F23	9052A-KGB4-C10	0	E14
90081-0E35-C00	0	E04	90304-GHE8-C00	1	F05	90545-3L00-C00	2	F04
90082-0E35-C00	0	E02	90304-LBA8-C10	1	F19	90601-LBA8-C10	0	E16
90082-0E35-C00	0	E05	90305-GHK8-C00	1	F23	90605-1F66-C00	0	E07
90084-LBA8-E80	0	E10	90306-KLF0-C00	0	F10	90605-LBA8-C10	0	E16
90087-4H28-E80	0	E10	90306-KLF0-C00	0	F12	90677-GAR1-C00	1	F15
90106-GEN5-901	1	F05	90309-GLW0-C00	0	F27	90677-GAR1-C00	1	F25
90108-KUDU-900	1	F20	90381-LBA8-C10	0	F15	90701-GFF6-C00	0	E05
90111-1G87-C00	1	F25	90401-LBA8-C10	0	E07	90701-HDC4-C00	1	E06
90111-KFW6-C00	0	F16	90432-0F86-C00	0	E07	90701-HDC4-C00	1	E10
90112-LBA8-C10	0	E17	90432-0F86-C00	0	E08	90701-LBA8-C10	0	E02
90121-LBA8-C10	2	F21	90441-0E35-C00	0	E04			

PART NO. INDEX

PART NO.	VERSION	PAGE	PART NO.	VERSION	PAGE	PART NO.	VERSION	PAGE
91000			92000			93903-34280	0	F15
91004-LBA8-C10	0	E12	92000-06022-0H	0	F18	93903-34380	6	F05
91021-1H48-C00	0	E06	92000-06025-0H	0	F18	93903-34380	6	F15
91100-LBA8-C10	0	E17	92001-LBA8-C10	0	F12	93903-34380	6	F24
91101-LBA8-C10	0	E07	92201-06045-08	0	E13	93903-35320	4	F02
91201-KGB4-C10	0	E12	92201-06050-08	0	E13	93903-45380	0	F15
91202-KGB4-C10	1	E06	92700-KGE2-C10	0	E02	93903-GFY6-C00	2	F15
91203-KGB4-C11	0	E16	92812-10000	2	F21	94000		
91204-LBA8-C10	0	E12				94001-08080-0S	0	F11
91252-LBA8-C11	1	F10	93000			94001-08080-0S	0	F21
91254-LBA8-C10	0	F12				94021-10020-0S	0	F22
91258-4L10-007	1	F10	93404-06012-08	0	F13	94030-08080-0S	0	E06
91301-0G27-C00	0	E12	93404-06012-08	0	F15	94031-LBA8-C10	1	F21
91301-LBA8-C10	1	E17	93404-06012-08	0	F21	94050-05080	2	F23
91302-5G67-C00	0	E10	93404-06012-08	0	F23	94050-06080	2	F13
91302-KGB4-C11	0	E01	93404-06016-08	0	F07	94050-06080	2	F17
91303-3G77-C00	0	E10	93404-06016-08	0	F23	94050-06080	2	F23
91304-LBA8-C10	0	E02	93500-05006-00	0	E07	94050-06080	2	F24
91305-LBA8-C10	1	E06	93500-05012-0G	0	F03	94050-06080	2	F26
91306-LBA8-C10	1	E02	93500-06012-00	0	E06	94050-08080	4	F27
91307-0E35-W10	1	E06	93700-05018-08	0	F02	94050-08800-08	0	F19
			93891-05016-07	0	F15	94050-10080	1	E11
			93903-14380	0	F05	94101-06800	3	E11
			93903-14380	0	F23	94101-06800	3	F10

PART NO. INDEX

PART NO.	VERSION	PAGE	PART NO.	VERSION	PAGE	PART NO.	VERSION	PAGE
94101-08800	0	F11	95701-06012-08	3	F26	96001-06022-08	0	E09
94101-08800	0	F21	95701-06014-08	0	F26	96001-06032-08	1	E10
94101-10800	1	F22	95701-06016-08	1	F26	96001-06040-08	0	E06
94102-08800	0	E06	95701-06020-08	0	F07	96001-06050-08	1	E10
94102-10800	0	E11	95701-06022-08	0	F10	96001-06050-08	1	E14
94103-06800	0	F13	95701-06025-08	2	F07	96001-06060-08	0	E14
94103-LBA8-C10	0	F15	95701-06028-08	0	E02	96001-06065-08	0	E06
94111-06800	1	E12	95701-06032-08	1	E02	96001-06065-08	0	E14
94111-06800	1	F10	95701-06110-08	0	E01	96001-06080-08	0	E06
94111-10800	0	F21	95701-08016-08	1	F14	96100-60000-00	0	E08
94201-20150	0	F11	95701-08016-08	1	F19	96120-63010-10	0	F10
94201-20150	0	F21	95701-08025-08	2	F19	96120-63010-10	0	F12
94201-30250	0	F20	95701-08028-08	0	F19	96211-06000-D	0	F06
94301-10140	0	E14	95701-08030-08	0	F19	96211-06000-U	0	F06
94510-16000	0	E18	95701-08035-08	1	F27	96220-40100	0	E17
94510-20000	1	E18	95701-10045-08	0	F06	96700-06016-08	0	E17
94520-42000	0	E07						
95000			96000			98000		
			96001-06012-08	3	E17	98056-5771R-00	1	E01
95701-06008-08	0	F21	96001-06016-08	6	E09	98200-11000	1	F25
95701-06008-08	0	F26	96001-06016-08	6	E10			
95701-06012-07	0	F15	96001-06016-08	6	E17			
95701-06012-08	3	F04	96001-06020-08	2	E11			
95701-06012-08	3	F21	96001-06022-08	0	E01			
95701-06012-08	3	F24	96001-06022-08	0	E08			