

# PARTS CATALOGUE



## SCOOTERS

SH60AA(FR)

G-DINK 300i



Release Date : 2012/02/05  
Print Date : 2012/02/10

## ABOUT THIS PARTS LIST

- This parts list is compiled all service parts for model SH60AA(FR).
- Any difference between color chart and motorcycle will be revised according to motorcycle.
- The Mark:
  1. Marking "\*\*\*" must add color code in the end before ordering parts.
  2. Marking "#" are parts with modification, Please find the details from e-Parts system.
- When modification or additions to this parts list are made a revised edition at an appropriate time.



# CONTENTS

● ABOUT THIS PARTS LIST .....	1
● COLOR CHART OF SH60AA(FR) .....	3
● CONTENTS-ENGINE GROUP .....	11
● CONTENTS-FRAME GROUP .....	12
● ENGINE PARTS LIST .....	15
● FRAME PARTS LIST .....	47
● PART NO. INDEX .....	121

NO	MODEL			COLOR CHART OF SH60AA(FR)			
	PHOTO NO			NO. 1	NO. 2	NO. 3	NO. 4
	BASIC COLOR			Black Blue	Sapphire Blue Metallic	Bright Red	Bright Silver
	CODE			Black Blue	Sapphire Blue Metallic	Bright Red	Bright Silver
	PARTS NAME	PARTS NO.	VERSION	PB184PA	PB242MA	RR217PA	NH045MA
1	PROECTOR MUFFLER	18318-LHG7-E00	0	DKP			
2	END HANDLE	53102-KEC8-900	0	F1S			
3	END R STRGHANDLE	53105-LBB5-E00	2				
4	WHEEL RR CAST	42601-LHG7-E01	4				
5	WHEEL SET FR	44600-LHG7-305	0	HJA			
6	WHEEL, FR CAST	44601-LHG7-E00	3				
7	FORK ASSY. FR R	51400-LHG7-E00	6				
8	BOTTOM CASE R	51420-LHG7-E00	0				
9	FORK ASSY. FR L	51500-LHG7-E00	8	HUA			
10	BOTTOM CASE L	51520-LHG7-E00	0				
11	FORK ASSY RR	52000-LHG7-E00	7				
12	COVER LEFT	11341-LHG7-E00	5	HUP			
13	TAIL CAP MUFFLER	18306-LHG7-E00	0				
14	SKIRT R., SID	64305-LHG7-E00	1				
15	SKIRT L., SIDE	64306-LHG7-E00	1				
16	OUTER,FR. COVER	64307-LHG7-E00	0				
17	TOP COVER R,BODY	83530-LHG7-E00	0	N1P			
18	TOP COVER L,BODY	83630-LHG7-E00	0				
19	MIRROR ASSY R BACK	88110-LHG7-E00	1				
20	MIRROR ASSY L BACK	88120-LHG7-E00	1				
21	RR COVER L COVER	11343-LHG7-E00	2				
22	COVER,RADIATOR	19025-LHG7-E00	0				
23	COVER, UNDER	50613-LHG7-E00	0	N1R			
24	GRIP COMP THROT	53140-KKC4-900	0				
25	GRIP L HANDLE	53166-KGB5-900	0				
DATE OF STARTING-SALES							
DATE OF END-SALES							

NO	MODEL			COLOR CHART OF SH60AA(FR)			
	PHOTO NO			NO. 5	NO. 6		
	BASIC COLOR			Pearly White	Deep Silver Metallic		
	CODE			Pearly White	Deep Silver Metallic		
	PARTS NAME	PARTS NO.	VERSION	NH193PA	NH232MA		
1	PROECTOR MUFFLER	18318-LHG7-E00	0	DKP			
2	END HANDLE	53102-KEC8-900	0	F1S			
3	END R STRGHANDLE	53105-LBB5-E00	2				
4	WHEEL RR CAST	42601-LHG7-E01	4	HJA			
5	WHEEL SET FR	44600-LHG7-305	0				
6	WHEEL, FR CAST	44601-LHG7-E00	3				
7	FORK ASSY. FR R	51400-LHG7-E00	6	HUA			
8	BOTTOM CASE R	51420-LHG7-E00	0				
9	FORK ASSY. FR L	51500-LHG7-E00	8				
10	BOTTOM CASE L	51520-LHG7-E00	0				
11	FORK ASSY RR	52000-LHG7-E00	7	HUP			
12	COVER LEFT	11341-LHG7-E00	5				
13	TAIL CAP MUFFLER	18306-LHG7-E00	0				
14	SKIRT R., SID	64305-LHG7-E00	1	N1P			
15	SKIRT L., SIDE	64306-LHG7-E00	1				
16	OUTER,FR. COVER	64307-LHG7-E00	0				
17	TOP COVER R,BODY	83530-LHG7-E00	0				
18	TOP COVER L,BODY	83630-LHG7-E00	0				
19	MIRROR ASSY R BACK	88110-LHG7-E00	1				
20	MIRROR ASSY L BACK	88120-LHG7-E00	1	N1R			
21	RR COVER L COVER	11343-LHG7-E00	2				
22	COVER,RADIATOR	19025-LHG7-E00	0				
23	COVER, UNDER	50613-LHG7-E00	0				
24	GRIP COMP THROT	53140-KKC4-900	0				
25	GRIP L HANDLE	53166-KGB5-900	0				
DATE OF STARTING-SALES							
DATE OF END-SALES							

NO	MODEL			COLOR CHART OF SH60AA(FR)						
	PHOTO NO			NO. 1	NO. 2	NO. 3	NO. 4			
	BASIC COLOR			Black Blue	Sapphire Blue Metallic	Bright Red	Bright Silver			
	CODE			Black Blue	Sapphire Blue Metallic	Bright Red	Bright Silver			
	PARTS NAME	PARTS NO.	VERSION	PB184PA	PB242MA	RR217PA	NH045MA			
26	COVER METER, FR.	53203-LHG7-E00	0	N1R						
27	COVER METER.RR.	53204-LHG7-E00	5							
28	COVER, HANDLE LOW	53206-LHG7-E00	2							
29	COVER, RADIATOR	53207-LHG7-E00	0							
30	FENDER FR INNER	61110-LHG7-E00	2							
31	PLUG WIND SCREEN	64223-LEA7-E00	5							
32	GRILL,R/H.,FR COVER	64308-LHG7-E00	0							
33	GRILL,L/H.,FR COVER	64309-LHG7-E00	1							
34	FLOOR. PANEL	64310-LHG7-E00	4							
35	LID RESERVE TANK	64311-LHG7-E00	1							
36	COWL UNDER	64400-LHG7-E00	0							
37	FENDER RR TIRE	80100-LHG7-E00	3							
38	FENDER RR. INNER	80101-LHG7-E00	4							
39	FENDER REAR	80105-LHG7-E00	5							
40	COVER, CENTER	80151-LHG7-E00	0							
41	LID,FUEL TANK MAINT.	80152-LHG7-E00	0							
42	RUBBER FUEL CAP	80153-LEA7-E00	3							
43	COVER,FUEL CAP,LID	80154-LHG7-E00	0							
44	LEG SHIELD	81131-LHG7-E00	1							
45	RETAIN	81133-LHG7-E00	0							
46	CASE, FR INNER BOX	81136-LHG7-E00	0							
47	LID ASSY INNER BOX	8113A-LHG7-E00	3							
48	COVER ,SIDE R/H	83510-LHG7-E00	1							
49	COVER ,SIDE L/H	83610-LHG7-E00	1							
50	CAP MIRROR BRKT	88115-LBA2-E02	1							
DATE OF STARTING-SALES										
DATE OF END-SALES										

NO	MODEL			COLOR CHART OF SH60AA(FR)			
	PHOTO NO			NO. 5	NO. 6		
	BASIC COLOR			Pearly White	Deep Silver Metallic		
	CODE			Pearly White	Deep Silver Metallic		
	PARTS NAME	PARTS NO.	VERSION	NH193PA	NH232MA		
26	COVER METER, FR.	53203-LHG7-E00	0				
27	COVER METER.RR.	53204-LHG7-E00	5				
28	COVER, HANDLE LOW	53206-LHG7-E00	2				
29	COVER, RADIATOR	53207-LHG7-E00	0				
30	FENDER FR INNER	61110-LHG7-E00	2				
31	PLUG WIND SCREEN	64223-LEA7-E00	5				
32	GRILL,R/H.,FR COVER	64308-LHG7-E00	0				
33	GRILL,L/H.,FR COVER	64309-LHG7-E00	1				
34	FLOOR. PANEL	64310-LHG7-E00	4				
35	LID RESERVE TANK	64311-LHG7-E00	1				
36	COWL UNDER	64400-LHG7-E00	0				
37	FENDER RR TIRE	80100-LHG7-E00	3				
38	FENDER RR. INNER	80101-LHG7-E00	4				
39	FENDER REAR	80105-LHG7-E00	5				
40	COVER, CENTER	80151-LHG7-E00	0				
41	LID,FUEL TANK MAINT.	80152-LHG7-E00	0				
42	RUBBER FUEL CAP	80153-LEA7-E00	3				
43	COVER,FUEL CAP,LID	80154-LHG7-E00	0				
44	LEG SHIELD	81131-LHG7-E00	1				
45	RETAIN	81133-LHG7-E00	0				
46	CASE, FR INNER BOX	81136-LHG7-E00	0				
47	LID ASSY INNER BOX	8113A-LHG7-E00	3				
48	COVER ,SIDE R/H	83510-LHG7-E00	1				
49	COVER ,SIDE L/H	83610-LHG7-E00	1				
50	CAP MIRROR BRKT	88115-LBA2-E02	1				
DATE OF STARTING-SALES							
DATE OF END-SALES							

NO	MODEL			COLOR CHART OF SH60AA(FR)			
	PHOTO NO			NO. 1	NO. 2	NO. 3	NO. 4
	BASIC COLOR			Black Blue	Sapphire Blue Metallic	Bright Red	Bright Silver
	CODE			Black Blue	Sapphire Blue Metallic	Bright Red	Bright Silver
	PARTS NAME	PARTS NO.	VERSION	PB184PA	PB242MA	RR217PA	NH045MA
51	BAND HARNESS WIRE	90656-KUDU-900	0	N1R			
52	DISK FR BRAKE	45351-LEA5-E00	2	N1S			
53	CUSHION ASSY RR R	52400-LHG7-E00	5				
54	CUSHION ASSY RR L	52500-LHG7-E00	6	<div style="display: flex; justify-content: space-around;"> <div style="text-align: center;">BJP</div> <div style="text-align: center;">BSP</div> <div style="text-align: center;">EHP</div> <div style="text-align: center;">N8P</div> </div>			
55	FENDER FRONT	61100-LHG7-E00	2				
56	COVER FR.	64301-LHG7-E00	4				
57	MOLD FR.,R/H	64302-LHG7-E00	1				
58	MOLD FR.,L/H	64303-LHG7-E00	1				
59	COVER R,BODY	83500-LHG7-E00	1				
60	MOLD,R SIDE	83520-LHG7-E00	1				
61	COVER L ,BODY	83600-LHG7-E00	1				
62	MOLD, L SIDE	83620-LHG7-E00	1				
63	COVER,RR.CENTER	83750-LHG7-E00	0				
64	PROTECTOR EXHAUST	18325-LGE5-E00	1	NYS			
65	SEAT, ASSY.	77200-LHG7-E00	1	<div style="display: flex; justify-content: space-around;"> <div style="text-align: center;">T01</div> </div>			
66	BACK SEAT,COMP.	77210-LHG7-E00	0				
67	EMB K-LOGO 20mm	86102-LGE5-E00	1				
68	EMB BODY COVER	86202-LHG7-E00	1				
69	EMB MARK 300i	87140-LHG7-E00	2				
70	LABEL TIRE	87505-LEA5-E00	1				
71	LABEL CLEANNESS	87508-KKC4-E00	1				
72	CAUTION FILTER	87512-KEBE-E00	0				
73	CAUTION SIDE STAND	87541-GAR1-E00	1				
74	CAUTION MOBILE	87541-KKC2-E00	1				
75	MARK MAINT CAUTION	87542-GAR1-E00	2				
DATE OF STARTING-SALES							
DATE OF END-SALES							



NO	MODEL			COLOR CHART OF SH60AA(FR)							
	PHOTO NO			NO. 5	NO. 6						
	BASIC COLOR			Pearly White	Deep Silver Metallic						
	CODE			Pearly White	Deep Silver Metallic						
	PARTS NAME	PARTS NO.	VERSION	NH193PA	NH232MA						
51	BAND HARNESS WIRE	90656-KUDU-900	0	N1R							
52	DISK FR BRAKE	45351-LEA5-E00	2	N1S							
53	CUSHION ASSY RR R	52400-LHG7-E00	5								
54	CUSHION ASSY RR L	52500-LHG7-E00	6								
55	FENDER FRONT	61100-LHG7-E00	2								
56	COVER FR.	64301-LHG7-E00	4	NVP			NZP				
57	MOLD FR.,R/H	64302-LHG7-E00	1								
58	MOLD FR.,L/H	64303-LHG7-E00	1								
59	COVER R,BODY	83500-LHG7-E00	1								
60	MOLD,R SIDE	83520-LHG7-E00	1								
61	COVER L ,BODY	83600-LHG7-E00	1								
62	MOLD, L SIDE	83620-LHG7-E00	1								
63	COVER,RR.CENTER	83750-LHG7-E00	0								
64	PROTECTOR EXHAUST	18325-LGE5-E00	1					NYS			
65	SEAT, ASSY.	77200-LHG7-E00	1					T01			
66	BACK SEAT,COMP.	77210-LHG7-E00	0								
67	EMB K-LOGO 20mm	86102-LGE5-E00	1								
68	EMB BODY COVER	86202-LHG7-E00	1								
69	EMB MARK 300i	87140-LHG7-E00	2								
70	LABEL TIRE	87505-LEA5-E00	1								
71	LABEL CLEANNESS	87508-KKC4-E00	1								
72	CAUTION FILTER	87512-KEBE-E00	0								
73	CAUTION SIDE STAND	87541-GAR1-E00	1								
74	CAUTION MOBILE	87541-KKC2-E00	1								
75	MARK MAINT CAUTION	87542-GAR1-E00	2								
DATE OF STARTING-SALES											
DATE OF END-SALES											













E01

# Crank Case

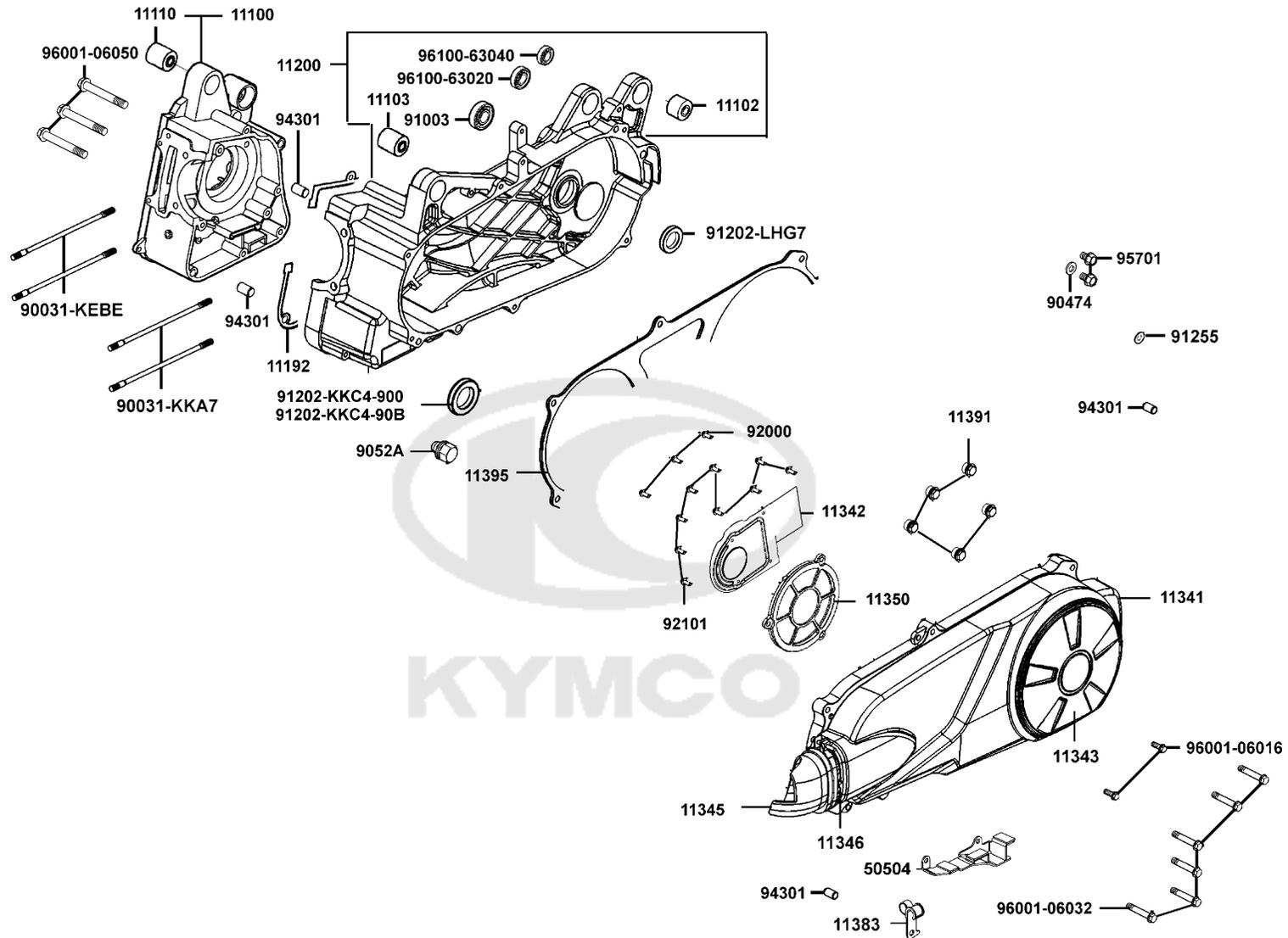



Sales mark	Ref no	Part no	Description	Reg description	Regd no	E01
	11100	11100-LDB2-305	CRANK CASE COMP R	CRANK CASE COMP R	1	
	11102	11102-1G87-004	RUB BUSH ENG HANGER	RUB BUSH ENG HANGER	1	
	11103	11103-KHE7-900	RUB BUSH ENG HANGER	RUB BUSH ENG HANGER	1	
	11110	11110-LLJ3-E00	RUB BUSH ENG HANGER	BUSH ASSY ENG HANGER	1	
	11192	11192-KHE7-900	GASKET CRANK CASE A	GASKET CRANK CASE @ A	1	
	11200	11200-KKC4-305	CRANK CASE SET L	CRANK CASE SET L	1	
**	11341	11341-LHG7-E00	COVER LEFT	COVER LEFT	1	
	11342	11342-LHG7-E00	PLATE L COVER	PLATE L COVER	1	
**	11343	11343-LHG7-E00	RR COVER L COVER	RR COVER L COVER	1	
	11345	11345-LHG7-E00	DUCT L COVER	DUCT L COVER	1	
	11346	11346-GFY6-901	BAND L COVER DUCT	BAND L COVER DUCT	1	
	11350	11350-LHG7-E00	ELEMENT COMP L COVER	ELEMENT COMP L COVER	1	
	11383	11383-KUDU-900	CLAMPER BRTH DRAIN TUBE	CLAMPER BREATHER DRAIN TUBE	1	
	11391	11391-LHG7-E00	PACKING L COVER	PACKING L COVER	1	
	11395	11395-KHE7-900	GASKET L COVER @ A	GASKET L COVER @ A	1	
	50504	50504-LHG7-E00	STOPPER PLATE MAIN STAND	STOPPER PLATE MAIN STAND	1	
	90031-KEBE	90031-KEBE-900	BOLT A STUD 8MM	BOLT A STUD 8MM	2	
	90031-KKA7	90031-KKA7-900	BOLT STUD	BOLT A STUD 8MM	2	
	90474	90474-3C33-001	WASHER 8MM	WASHER 8MM	1	
	9052A	9052A-GFY6-950	BOLT ASSY DRAIN PLUG	BOLT ASSY DRAIN PLUG	1	

E01

# Crank Case

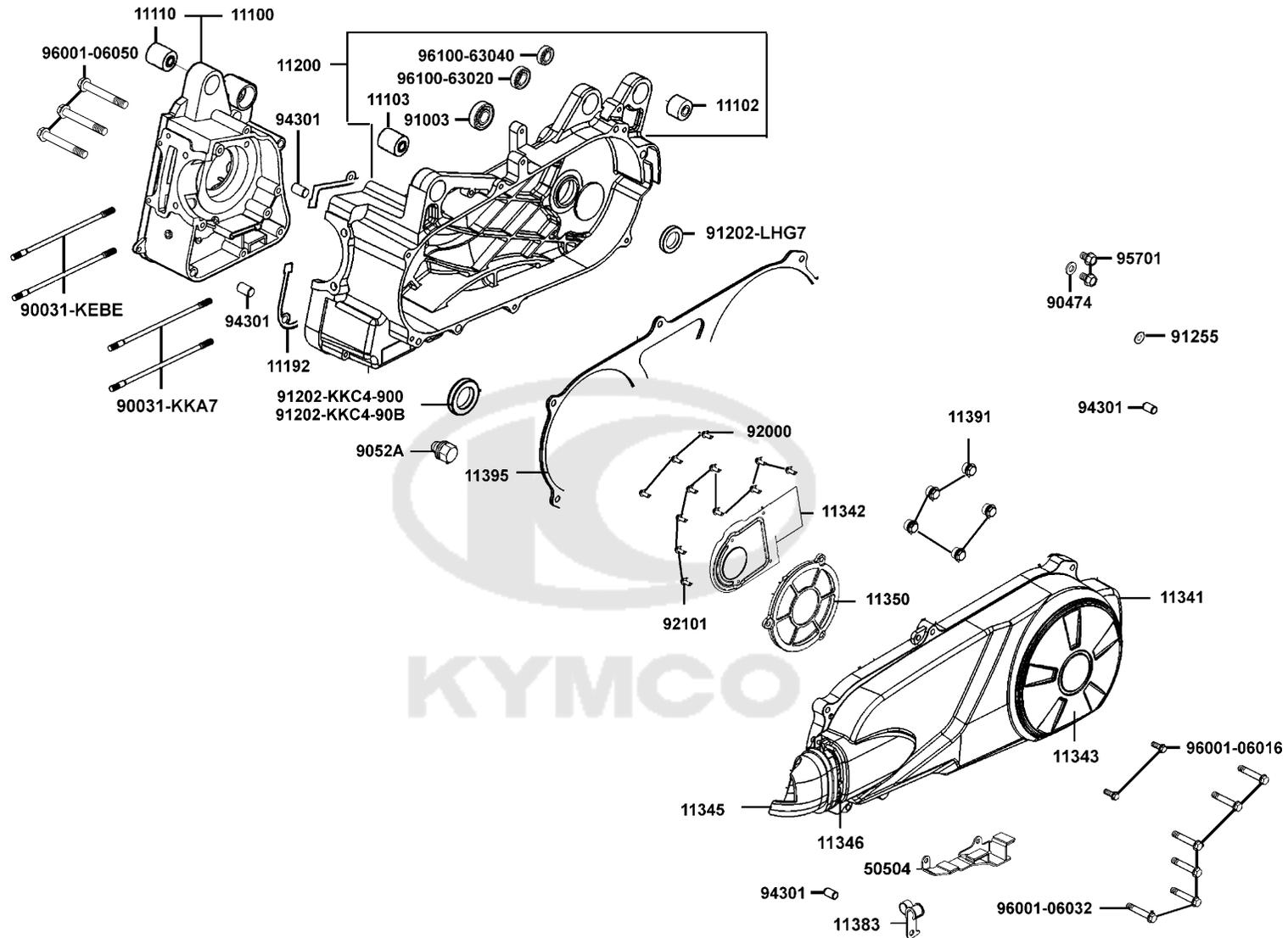

Sales mark	Ref no	Part no	Description	Reg description	Regd no	E01
91003		91003-KHE7-900	BRG BALL RADIAL TMB2/22CCS15	BRG BALL RADIAL	1	
91202-KKC4-900		91202-KKC4-900	OIL SEAL 27*42*7	OIL SEAL 27*42*7	1	
91202-KKC4-90B		91202-KKC4-90B	OIL SEAL 27X42X7	OIL SEAL 27X42X7	1	
91202-LHG7		91202-LHG7-E00	OIL SEAL 22X34X6	OIL SEAL 22X34X6	1	
91255		91255-KHE7-900	OIL SEAL 34*52*7	OIL SEAL 34*52*7	1	
92000		92000-05012-0H	BOLT HEX 5*12 (C)	BOLT HEX 5*12 (C)	3	
92101		92101-05008-0A	BOLT HEX 5*8	BOLT HEX 5*8	9	
94301		94301-10160	DOWEL PIN 10*16	DOWEL PIN 10*16	4	
95701		95701-08012-08	BOLT FLANGE 8*12	BOLT FLANGE 8*12	2	
96001-06016		96001-06016-08	BOLT FLANGE SH 6*16	BOLT FLANGE SH 6*16	2	
96001-06032		96001-06032-08	BOLT FLANGE SH 6*32	BOLT FLANGE SH 6*32	6	
96001-06050		96001-06050-08	BOLT FLANGE 6*50	BOLT FLANGE 6*50	3	
96100-63020		96100-63020-00	BRG BALL RADIAL 6302	BRG BALL RADIAL 6302	1	
96100-63040		96100-63040-00	BRG BALL RADIAL 6304	BRG BALL RADIAL 6304	1	



Sales mark	Ref no	Part no	Description	Reg description	Regd no	E02
	11387	11387-LHG7-E00	CLAMPER BREATHER TUBE	CLAMPER BREATHER TUBE	1	
	12200	12200-LHG7-E00	HEAD COMP CYLINDER	HEAD COMP CYLINDER	1	
	12205	12205-KHE8-301	BOLT SEALING 12MM	BOLT SEALING 12MM	1	
	12209-GDB4-68A	12209-GDB4-68A	SEAL VALVE STEM	SEAL VALVE STEM	2	
	12209-GDB4-68B	12209-GDB4-68B	SEAL VALVE STEM	SEAL VALVE STEM	2	
	1221A	1221A-LDB2-E00	HOLDER COMP CAM SHAFT	HOLDER COMP CAM SHAFT	1	
	12251	12251-KHE7-901	GASKET CYLINDER HEAD	GASKET CYLINDER HEAD	1	
	12310	12310-LDB2-E00	COVER COMP CYLN HEAD	COVER COMP CYLN HEAD	1	
	12391	12391-LDB2-E00	GASKET HEAD COVER	GASKET HEAD COVER	1	
	14100	14100-LFG2-E00	SHAFT COMP CAM	SHAFT COMP CAM	1	
	14150	14150-LDB2-E00	PLATE COMP STOPPER	PLATE COMP STOPPER	1	
	14431	14431-LDB2-E00	ARM VALVE ROCKER	ARM VALVE ROCKER	2	
	14450	14450-KEBE-900	SHAFT COMP IN ROCKER ARM	SHAFT COMP IN ROCKER ARM	1	
	14452	14452-LDB2-E00	SHAFT EX ROCKER	SHAFT EX ROCKER	1	
	14711	14711-LFG2-E00	VALVE INLET	VALVE INLET	1	
	14721	14721-LFG2-E00	VALVE EXHAUST	VALVE EXHAUST	1	
	14751	14751-KHE7-900	SPG VALVE OUTER	SPG VALVE OUTER	2	
	14761	14761-KHE7-900	SPG VALVE INNER	SPG VALVE INNER	2	
	14771	14771-GDB4-680	RETAINER VALVE SPRING	RETAINER VALVE SPRING	2	
	14775	14775-MFA6-001	SEAT VALVE SPG OUTER	SEAT VALVE SPG OUTER	2	



Sales mark	Ref no	Part no	Description	Reg description	Regd no	E02
	14781	14781-MFA6-001	COTTER VALVE	COTTER VALVE	4	
	16201	16201-LHG7-E00	GASKET INSULATOR	GASKET INSULATOR	1	
	16211	16211-LDF2-900	INSULATOR CARB	INSULATOR CARB	1	
	17113	17113-LHG7-E00	CLAMPER FUEL TUBE	CLAMPER FUEL TUBE	1	
	1711A	1711A-LDF2-M90	PIPE ASSY INLET	PIPE ASSY INLET	1	
	19300	19300-KAE1-004	THERMOSTAT ASSY	THERMOSTAT ASSY	1	
	19310	19310-LDF2-900	CASE COMP THERMOSTAT	CASE COMP THERMOSTAT	1	
	19315	19315-LDB2-E00	COVER THERMOSTAT	COVER THERMOSTAT	1	
	19503	19503-LHG7-E00	HOSE C WATER	HOSE C WATER	1	
	19507	19507-LDB5-E00	CLAMP D 28	CLAMP D28	1	
	32101	32101-LEA7-E00	SUB HARNESS THERMO UNIT	SUB HARNESS THERMO UNIT	1	
	32311	32311-LHG7-E00	CLAMPER CORD	CLAMPER CORD	1	
	37720	37720-KGB5-900	EARTH TERMINAL THERMO	EARTH TERMINAL THERMO	1	
	37750	37750-PAC1-005	THERMO UNIT ASSY	THERMO UNIT ASSY	1	
	39300	39300-LHG7-E00	INJECTOR FUEL	INJECTOR FUEL	1	
	39301	39301-LDF2-M90	INJECTOR	INJECTOR	1	
	39400	39400-LDF2-800	WATER TEMP SENSOR	WATER TEMP SENSOR	1	
	90012	90012-3C33-001	SCREW TAPPET ADJUSTING	SCREW TAPPET ADJUSTING	2	
	90033	90033-GFY6-900	BOLT STUD 8*32	BOLT STUD 8*32	2	
	90206	90206-0A01-001	NUT TAPPET ADJG	NUT TAPPET ADJG	2	





Sales mark	Ref no	Part no	Description	Reg description	Regd no	E02
	90465	90465-MDC4-001	WASHER 8MM	WASHER 8MM	4	
	90478	90478-7L00-001	WASHER A 6MM	WASHER A 6MM	2	
	90652	90652-GFY6-901	BAND 49 AIR/C CONNECTING TUBE	BAND 49 AIR/C CONNECTING TUBE	1	
	90914	90914-LHG7-E00	TUBE ASSY WATER	TUBE ASSY WATER	1	
	91301-KHE7	91301-KHE7-900	O-RING 17.8*1.9	O-RING 17.8*1.9	1	
	91301-LDF2	91301-LDF2-M90	O-RING 7.3*2.2	O-RING 7.3*2.2	1	
	91302-LDB2	91302-LDB2-E00	O-RING 37*3	O-RING 37*3	1	
	91302-LDF2	91302-LDF2-M90	SEAL RING	SEAL RING	1	
	92900	92900-06050-0B	BOLT STUD 6*50	BOLT STUD 6*50	2	
	93500	93500-05016-0H	SCREW PAN 5*16	SCREW PAN 5*16	2	
	94050-06080	94050-06080	NUT FLANGE 6MM	NUT FLANGE 6MM	2	
	94050-08080	94050-08080	NUT FLANGE 8MM	NUT FLANGE 8MM	4	
	94301	94301-10160	DOWEL PIN 10*16	DOWEL PIN 10*16	4	
	94591	94591-KFBF-900	CLIP 2*70	CLIP 2*71	2	
	95002	95002-02070	CLIP B7 TUBE	CLIP B7 TUBE	2	
	95701-06012	95701-06012-08	BOLT FLANGE 6*12	BOLT FLANGE 6*12	3	
	95701-06025-08	95701-06025-08	BOLT FLANGE 6*25	BOLT FLANGE 6*25	3	
	95701-06028	95701-06028-08	BOLT FLANGE 6*28	BOLT FLANGE 6*28	1	
	96001-06018	96001-06018-08	BOLT FLANGE SH 6*18	BOLT FLANGE SH 6*18	1	
	96001-06110	96001-06110-08	BOLT FLANGE SH 6*110	BOLT FLANGE SH 6*110	2	



Sales mark	Ref no	Part no	Description	Reg description	Regd no	<b>E02</b>
------------	--------	---------	-------------	-----------------	---------	------------

98069

98069-5691R-00

SPARK PLUG (DPR6EA-9)

SPARK PLUG (DPR6EA-9)

1



Cylinder Piston Crankshaft

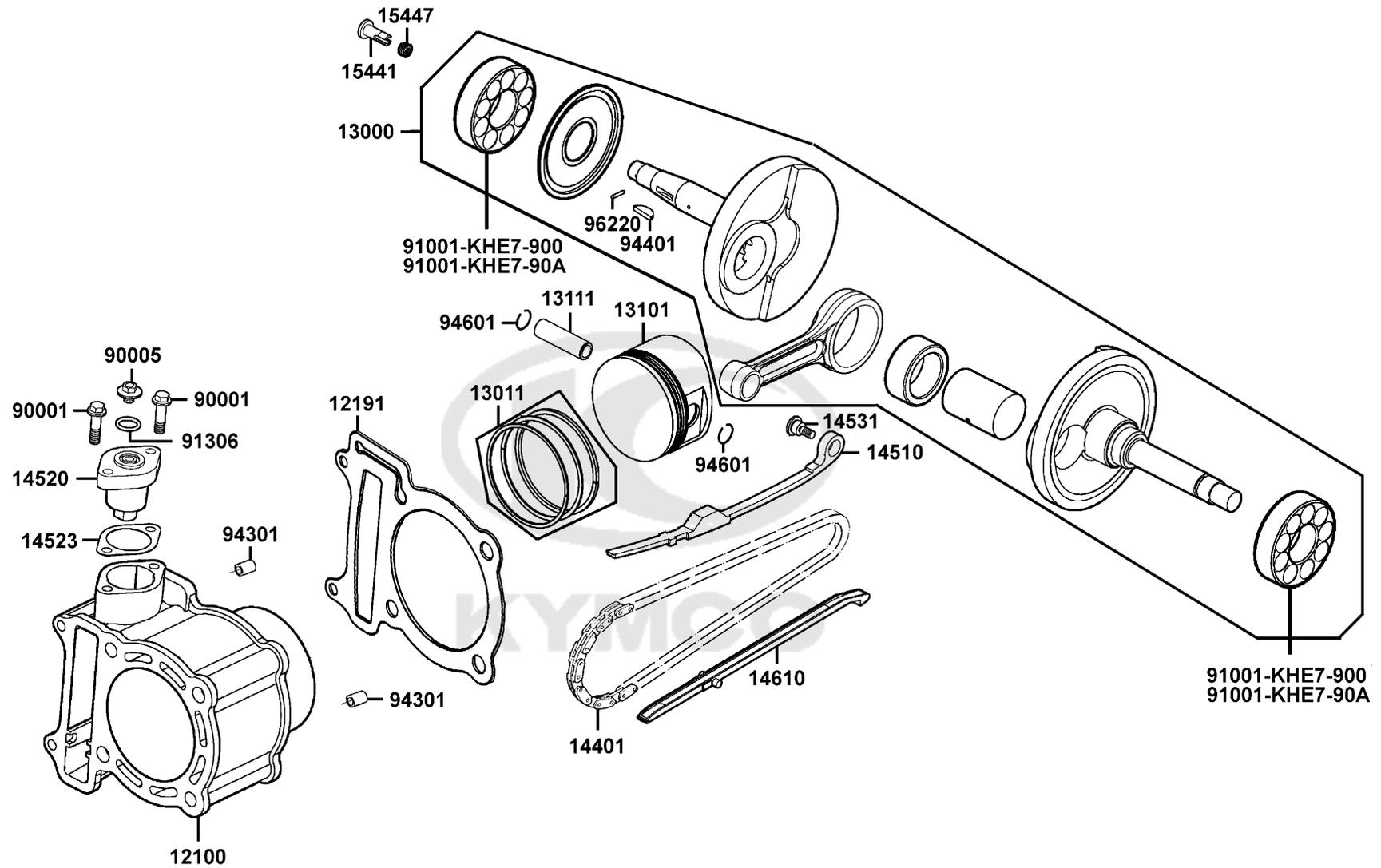

Sales mark	Ref no	Part no	Description	Reg description	Regd no	E03
	12100	12100-LDE9-E00	CYLINDER COMP	CYLINDER COMP	1	
	12191	12191-KHE7-910	GASKET CYLINDER	GASKET CYLINDER	1	
	13000	13000-LFG2-E00	CRANK SHAFT COMP	CRANK SHAFT COMP	1	
	13011	13011-LHG7-E00	RING ASSY PISTON	RING ASSY PISTON	1	
	13101	13101-LHG7-E00	PISTON	PISTON	1	
	13111	13111-LDB2-E00	PIN PISTON	PIN PISTON	1	
	14401	14401-LDE9-E00	CHAIN CAM	CHAIN CAM	1	
	14510	14510-LDE9-E00	TENSIONER CAM CHAIN	TENSIONER CAM CHAIN	1	
	14520	14520-GFY6-90A	LIFTER ASSY TENSIONER	LIFTER ASSY TENSIONER	1	
	14523	14523-KED9-900	GASKET TENSIONER LIFTER @A	GASKET TENSIONER LIFTER @A	1	
	14531	14531-KHE7-900	PIVOT CAM CHAIN TENSIONER	PIVOT CAM CHAIN TENSIONER	1	
	14610	14610-LDE9-E00	GUIDE COMP CAM CHAIN	GUIDE COMP CAM CHAIN	1	
	15441	15441-1K49-001	OIL THROUGH	OIL THROUGH	1	
	15447	15447-1K49-001	SPG OIL THROUGH	SPG OIL THROUGH	1	
	90001	90001-GBHB-661	BOLT FLANGE SH 6*22	BOLT FLANGE SH 6*22	2	
	90005	90005-KEC8-900	BOLT SPECIAL 6*6	BOLT SPECIAL 6*6	1	
	91001-KHE7-900	91001-KHE7-900	BRG BALL RADIAL TMB307JR2CS19	BRG BALL RADIAL	2	
	91001-KHE7-90A	91001-KHE7-90A	BRG BALL RADIAL TMB307JR2CS19	BRG BALL RADIAL 6307	2	
	91306	91306-1E05-691	O-RING 1.5*9.5	O-RING 1.5*9.5	1	
	94301	94301-10160	DOWEL PIN 10*16	DOWEL PIN 10*16	2	

# Cylinder Piston Crankshaft

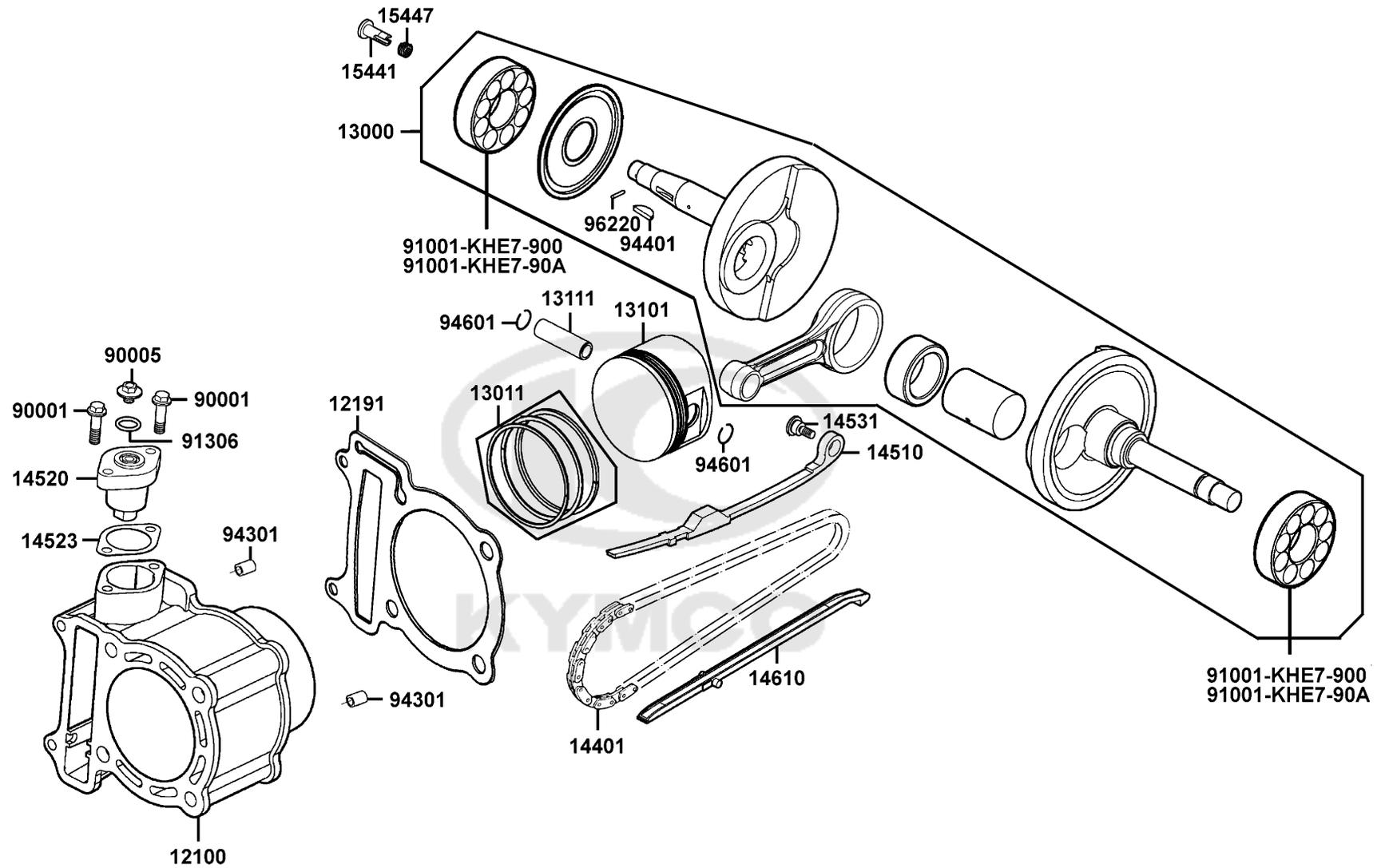

Sales mark	Ref no	Part no	Description	Reg description	Regd no	<b>E03</b>
------------	--------	---------	-------------	-----------------	---------	------------

94401		94401-25140	WOODRUFF KEY 25*14	WOODRUFF KEY 25*14	1	
94601		94601-17000	CLIP PISTON PIN 17MM	CLIP PISTON PIN 17MM	2	
96220		96220-20118	ROLLER 2*11.8	ROLLER 2*11.8	1	



E04

# Right Crankcase Cover Water Pump

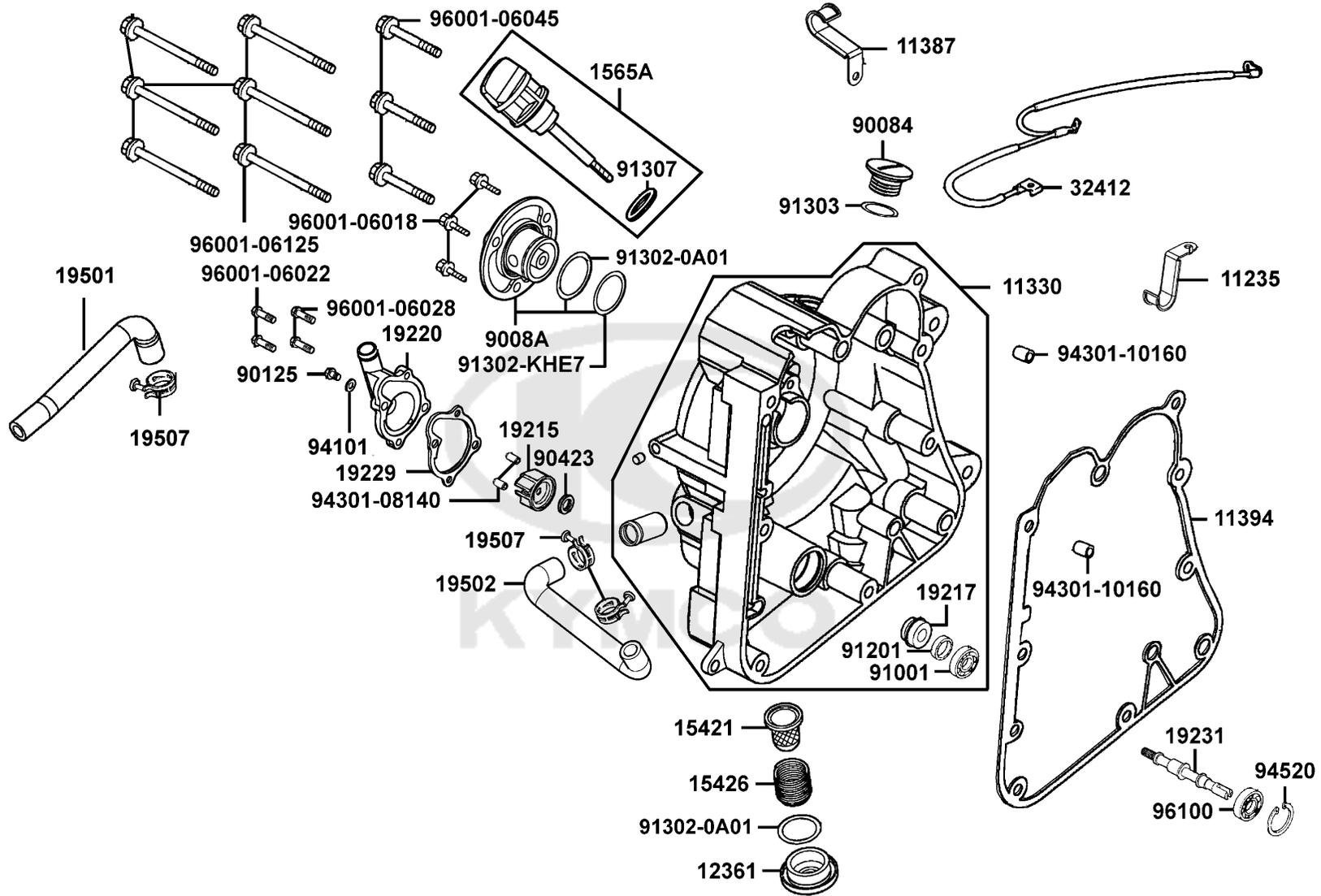



Sales mark	Ref no	Part no	Description	Reg description	Regd no	E04
	11235	11235-LHG7-E00	CLAMPER BRAKE WIRE	CLAMPER BRAKE WIRE	1	
	11330	11330-KHE7-900	COVER COMP RIGHT	COVER COMP RIGHT	1	
	11387	11387-LHG7-E00	CLAMPER BREATHER TUBE	CLAMPER BREATHER TUBE	1	
	11394	11394-KHE7-900	GASKET R COVER @ A	GASKET R COVER @ A	1	
	12361	12361-GFY6-901	HOLE CAP TAPPET ADJUSTING	HOLE CAP TAPPET ADJUSTING	1	
	15421	15421-1G07-001	SCREEN OIL FILTER	SCREEN OIL FILTER	1	
	15426	15426-GAE1-921	SPG OIL FILTER SCREEN	SPG OIL FILTER SCREEN	1	
	1565A	1565A-LHG7-E00	GUAGE OIL LEVEL ASSY.	GUAGE OIL LEVEL ASSY.	1	
	19215	19215-LHG7-E00	IMPELLER WATER PUMP	IMPELLER WATER PUMP	1	
	19217	19217-6G57-024	SEAL MECHANICAL	SEAL MECHANICAL	1	
	19220	19220-LHG7-305	COVER ASSY WATER PUMP	COVER ASSY WATER PUMP	1	
	19229	19229-KHE7-900	GASKET WATER PUMP	GASKET WATER PUMP	1	
	19231	19231-KKJ9-011	SHAFT WATER PUMP	SHAFT WATER PUMP	1	
	19501	19501-LHG7-E00	HOSE A WATER	HOSE A WATER	1	
	19502	19502-KHE7-900	HOSE B WATER	HOSE B WATER	1	
	19507	19507-LDB5-E00	CLAMP D 28	CLAMP D28	3	
	32412	32412-LKB9-900	CABLE EARTH	CABLE EARTH	1	
	90084	90084-4H28-001	CAP ACG	CAP ACG	1	
	9008A	9008A-KHE7-900	CAP ASSY R COVER	CAP ASSY R COVER	1	
	90125	90125-05010-0D	BOLT FLANGE SH 5*10	BOLT FLANGE SH 5*10	1	

E04

# Right Crankcase Cover Water Pump

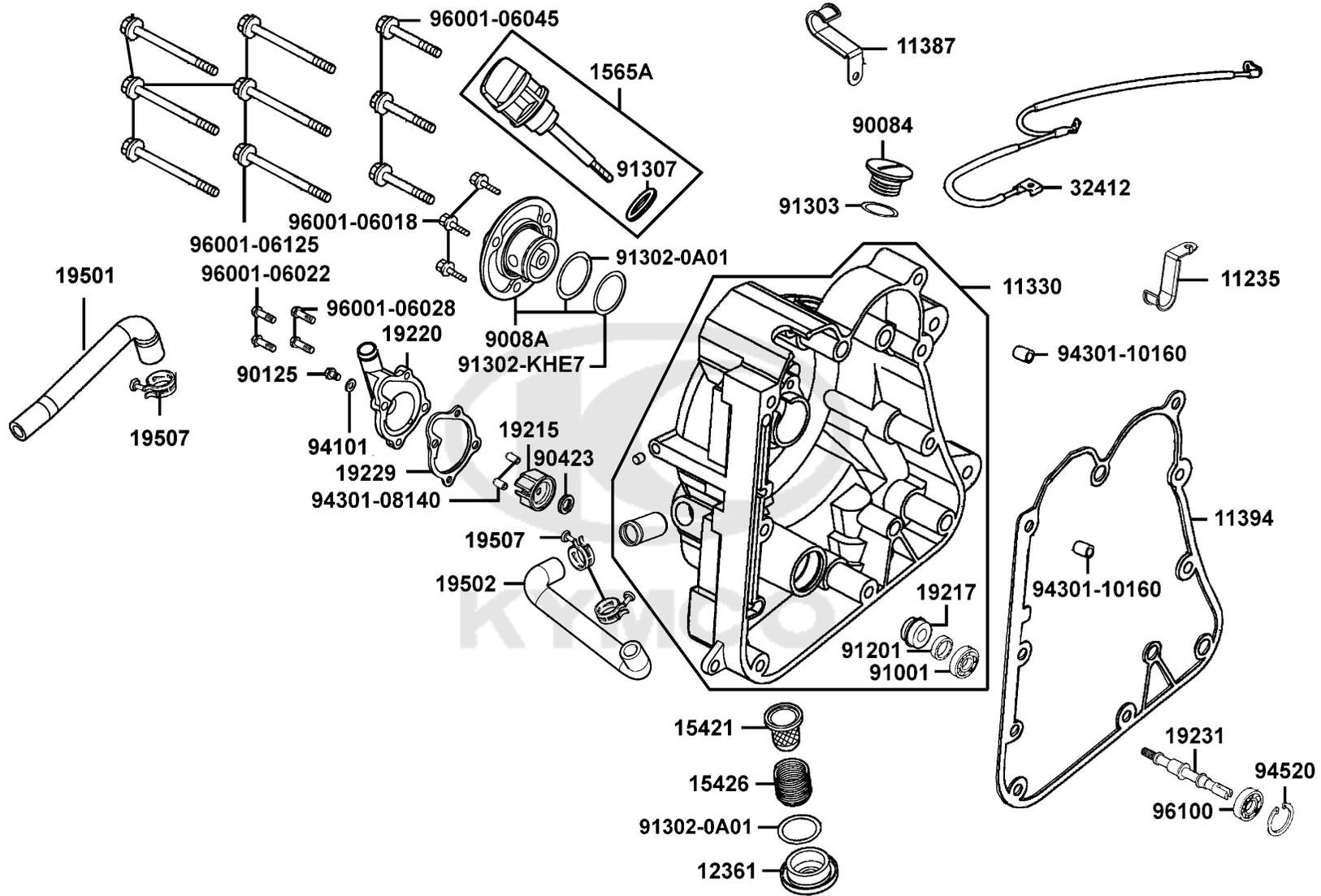

Sales mark	Ref no	Part no	Description	Reg description	Regd no	<b>E04</b>
90423		90423-KKJ9-001	WASHER 7.2*13*1.2	WASHER 7.2*13*1.2	1	
91001		91001-KKJ9-006	BRG BALL RADIAL 6901	BEARING BALL RADIAL 6901	1	
91201		91201-KKJ9-004	OIL SEAL 12*20*4	OIL SEAL 12*20*4	1	
91302-0A01		91302-0A01-021	O-RING 30.8MM	O-RING 30.8MM	2	
91302-KHE7		91302-KHE7-900	O-RING 27.4*2.1MM	O-RING 27.4*2.1MM	1	
91303		91303-3G77-001	O-RING 13.8*2.5	O-RING 13.8*2.5	1	
91307		91307-0E35-001	O RING 18*3	O-RING 18*3	1	
94101		94101-05800	WASHER PLAIN 5MM	WASHER PLAIN 5MM	1	
94301-08140		94301-08140	DOWEL PIN 8*14	DOWEL PIN 8*14	2	
94301-10160		94301-10160	DOWEL PIN 10*16	DOWEL PIN 10*16	2	
94520		94520-26000	CIR CLIP INTERAL 26MM	CIR CLIP INTERAL 26MM	1	
96001-06018		96001-06018-02	BOLT FLANGE SH 6*18	BOLT FLANGE SH 6*18	3	
96001-06022		96001-06022-08	BOLT FLANGE SH 6*22	BOLT FLANGE SH 6*22	2	
96001-06028		96001-06028-08	BOLT FLANGE SH 6*28	BOLT FLANGE SH 6*28	2	
96001-06045		96001-06045-08	BOLT FLANGE SH 6*45	BOLT FLANGE SH 6*45	3	
96001-06125		96001-06125-08	BOLT FLANGE SH 6*125	BOLT FLANGE SH 6*125	6	
96100		96100-60000-00	BEARING BALL RADIAL 6000	BEARING BALL RADIAL 6000	1	

Transmission Pulley

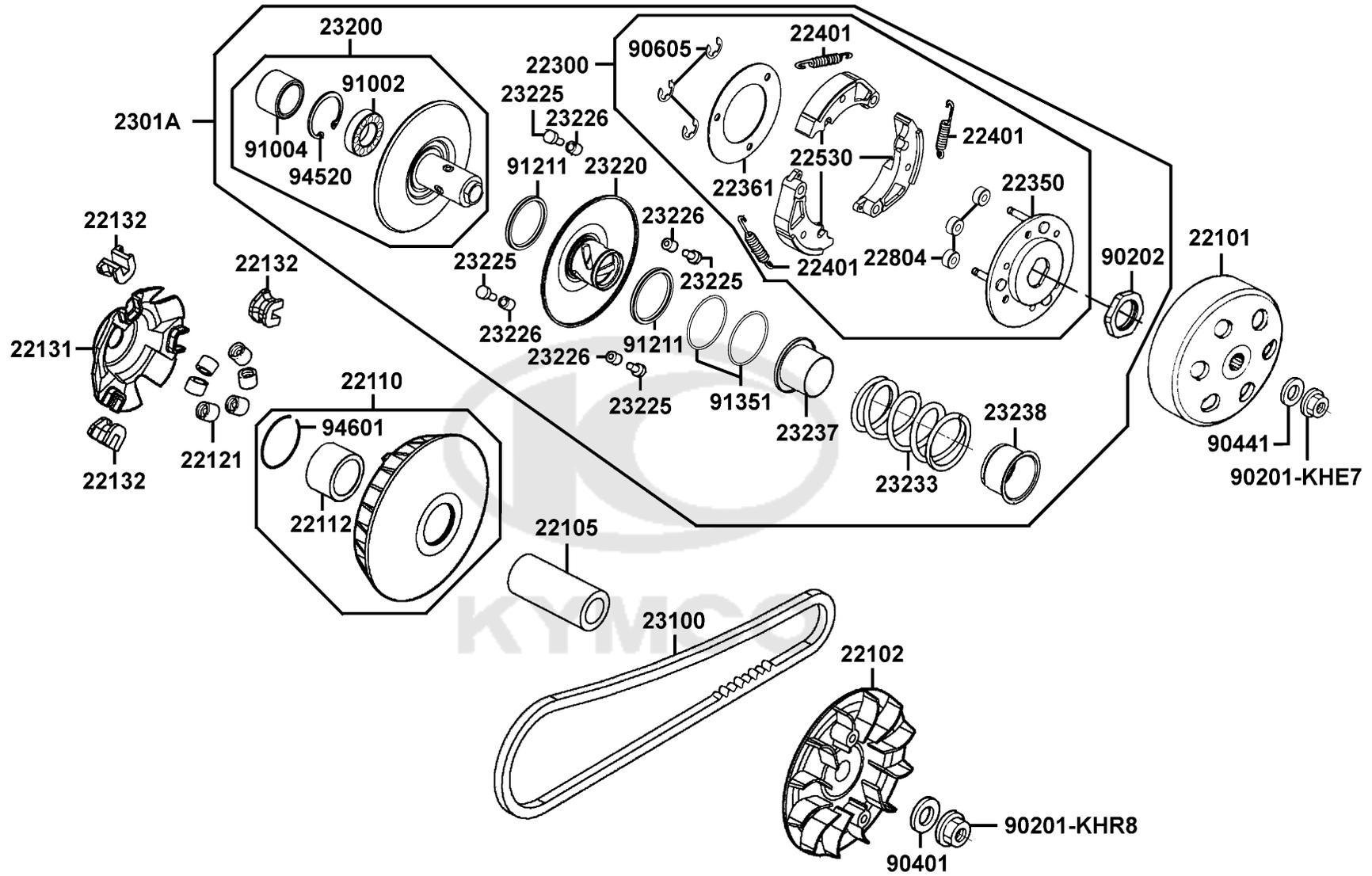

Sales mark	Ref no	Part no	Description	Reg description	Regd no	<b>E05</b>
22101		22101-KHE7-900	OUTER CLUTCH	OUTER CLUTCH	1	
22102		22102-KHE7-900	FACE DRIVE	FACE DRIVE	1	
22105		22105-LHG7-E00	BOSS DRIVE FACE	BOSS DRIVE FACE	1	
22110		22110-LFG1-E00	FACE COMP MOVABLE DRIVE	FACE COMP MOVABLE DRIVE	1	
22112		22112-KHE7-900	BUSH 27*33*37	BUSH 27*33*37	1	
22121		22121-KHE7-90A	ROLLER COMP WEIGHT	ROLLER COMP WEIGHT	6	
22131		22131-LBA7-900	PLATE RAMP	PLATE RAMP	1	
22132		22132-KHE7-900	PIECE SLIDE	PIECE SLIDE	3	
22300		22300-LHG7-E80	PLATE ASSY DRIVE	PLATE ASSY DRIVE	1	
22350		22350-KHE7-900	PLATE COMP DRIVE	PLATE COMP DRIVE	1	
22361		22361-LEA7-E00	PLATE CLUTCH SIDE	PLATE CLUTCH SIDE	1	
22401		22401-KHE7-900	SPRING CLUTCH	SPRING CLUTCH	3	
22530		22530-LFG2-E80	WEIGHT CLUTCH	WEIGHT CLUTCH	3	
22804		22804-GBB2-001	RUBBER CLUTCH DAMPER	RUBBER CLUTCH DAMPER	3	
2301A		2301A-LHG7-E80	PULLEY SUB.ASS'Y	PULLEY SUB.ASS'Y	1	
23100		23100-LHG7-E00	BELT DRIVE	BELT DRIVE	1	
23200		23200-KHE7-900	FACE ASSY DRIVEN	FACE ASSY DRIVEN	1	
23220		23220-LFG2-E00	FACE RR MOVABLE DRIVEN	FACE RR MOVABLE DRIVEN	1	
23225		23225-KHE7-900	PIN ROLLER GUIDE	PIN ROLLER GUIDE	4	
23226		23226-GHC8-004	ROLLER GUIDE	ROLLER GUIDE	4	

Transmission Pulley

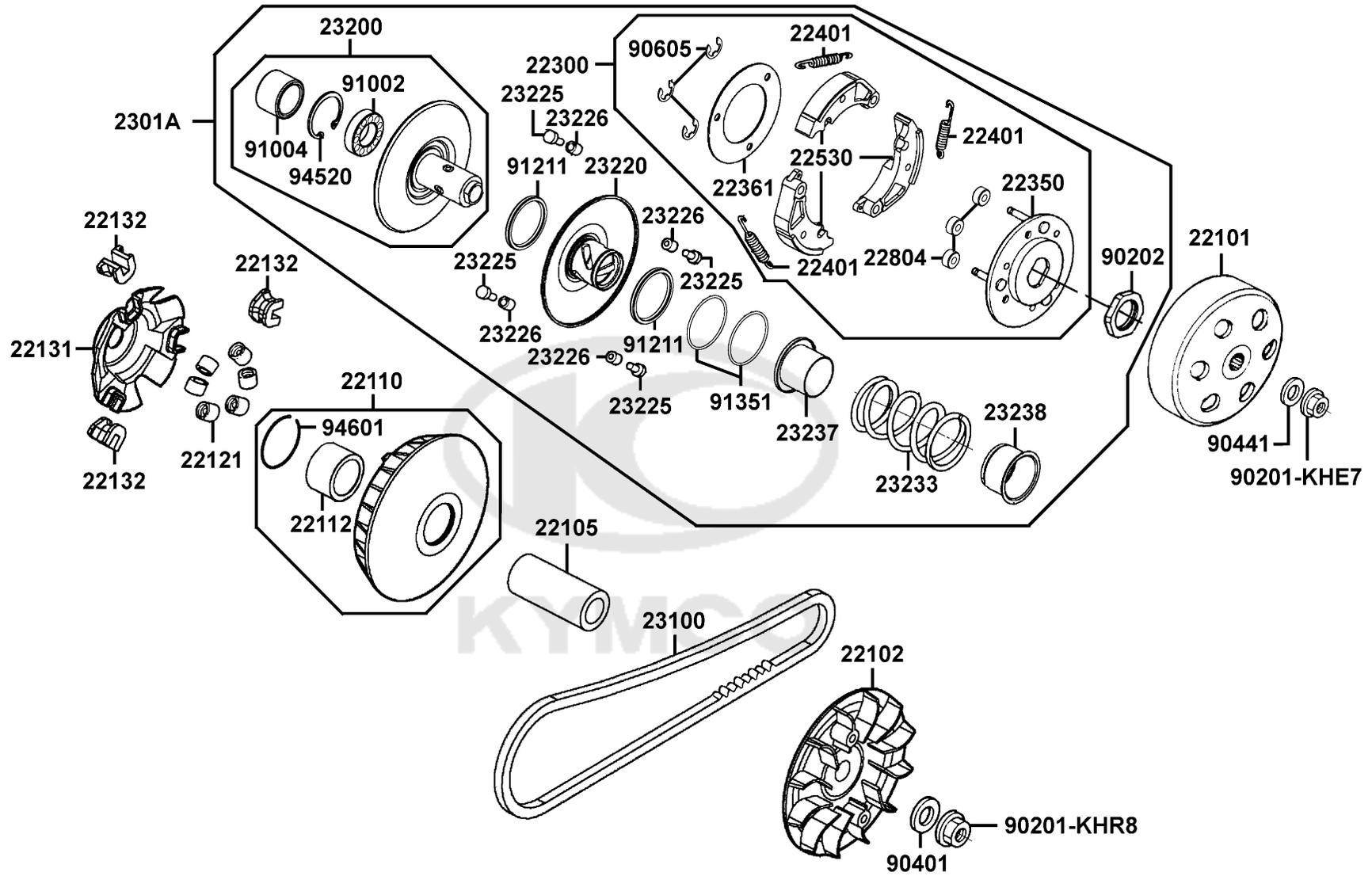

Sales mark	Ref no	Part no	Description	Reg description	Regd no	<b>E05</b>
23233		23233-KHE7-900	SPG DRIVEN FACE	SPG DRIVEN FACE	1	
23237		23237-KHE7-900	COLLAR SEAL	COLLAR SEAL	1	
23238		23238-KHE7-900	COLLAR SPG	COLLAR SPG	1	
90201-KHE7		90201-KHE7-900	NUT C FLANGE M12	NUT C FLANGE M12	1	
90201-KHR8		90201-KHR8-75A	NUT FLANGE 14MM	NUT FLANGE 14MM	1	
90202		90202-1G87-001	NUT SPECIAL 28MM	NUT SPECIAL 28MM	1	
90401		90401-KKJ9-001	WASHER THRUST 14*28*2	WASHER THRUST 14*28*2	1	
90441		90441-KKC4-800	WASHER PLAIN 15.5*23*0.5	WASHER PLAIN 15.5*23*0.5	1	
90605		90605-1F66-721	CIR CLIP 7MM	CIR CLIP 7MM	3	
91002		91002-GGA7-70A	BRG BALL RADIAL 6902U	BRG BALL RADIAL 6902U	1	
91004		91004-KHE7-900	BRG NDL 22*29*18	BRG NDL 22*29*18	1	
91211		91211-KHE7-900	SEAL DRIVEN FACE	SEAL DRIVEN FACE	2	
91351		91351-KHE7-900	O-RING PINION CAP	O-RING PINION CAP	2	
94520		94520-28000	CIR CLIP IN 28	CIR CLIP IN 28MM	1	
94601		94601-33000	CLIP PISTON PIN 33MM	CLIP PISTON PIN 33MM	1	

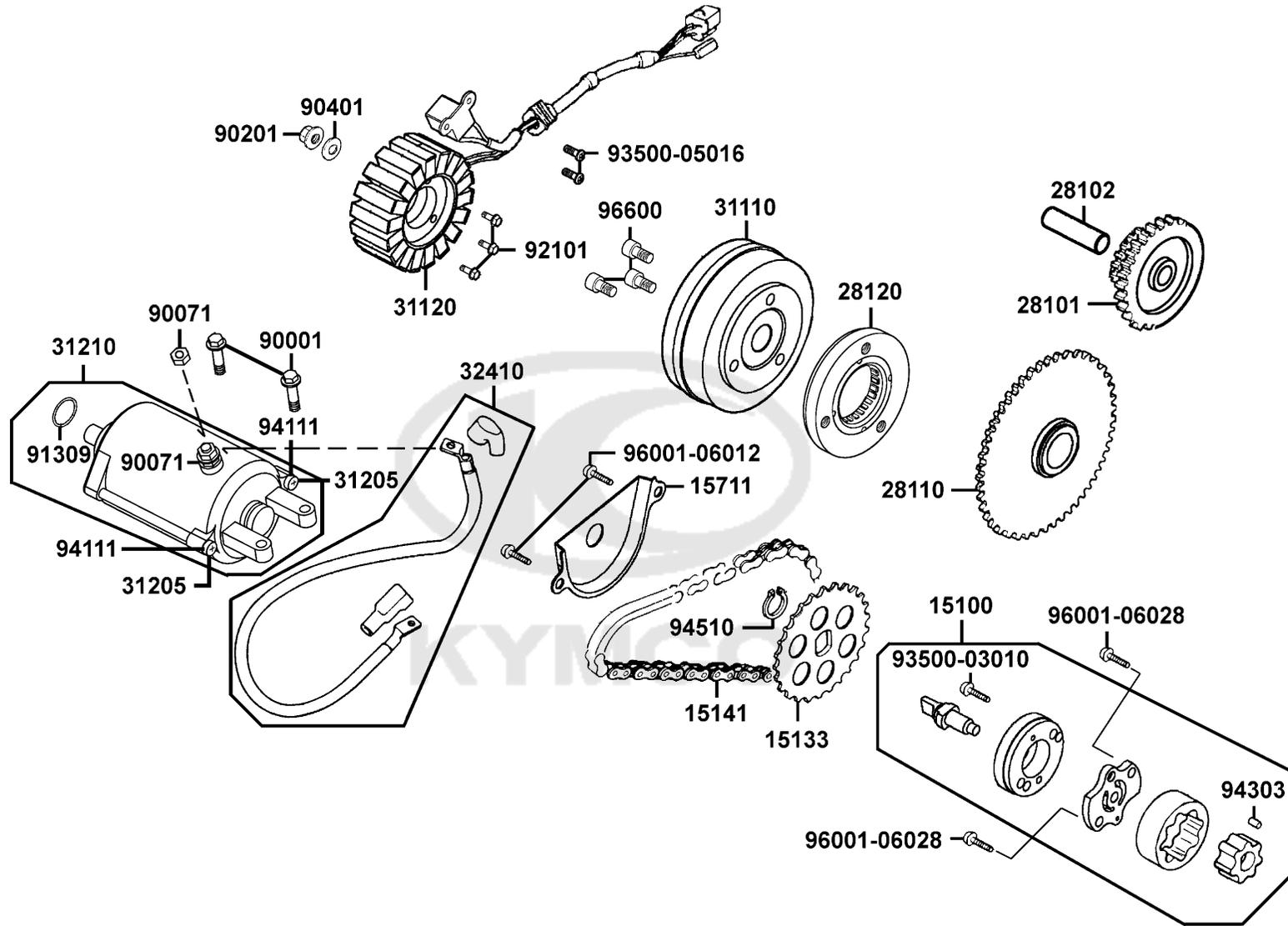



Sales mark	Ref no	Part no	Description	Reg description	Regd no	<b>E06</b>
15100		15100-KKC3-900	PUMP ASSY OIL	PUMP ASSY OIL	1	
15133		15133-KAM1-001	SPROCKET OIL PUMP DRIVE	SPROCKET OIL PUMP DRIVE	1	
15141		15141-KKJ9-004	CHAIN OIL PUMP	CHAIN OIL PUMP	1	
15711		15711-KHE7-900	SEPARATER OIL	SEPARATER OIL	1	
28101		28101-KHE7-900	GEAR STARTER REDUCTION	GEAR STARTER REDUCTION	1	
28102		28102-KHE7-900	SHAFT STARTER REDUCTION GEAR	SHAFT STARTER REDUCTION GEAR	1	
28110		28110-LDB2-E00	GEAR COMP STARTING CLUTCH	GEAR COMP STARTING CLUTCH	1	
28120		28120-LDB2-E00	ONE WAY CLUTCH	ONE WAY CLUTCH	1	
31110		31110-LHG7-E00	FLYWHEEL COMP	FLYWHEEL COMP	1	
31120		31120-LHG7-E00	STATOR COMP	STATOR COMP	1	
31205		31205-KKJ9-000	BOLT SET	BOLT SET	2	
31210		31210-KHE7-90A	MOTOR UNIT STARTER	MOTOR UNIT STARTER	1	
32410		32410-LHG7-E00	CABLE. START MOTOR	CABLE. START MOTOR	1	
90001		90001-GBHB-661	BOLT FLANGE SH 6*22	BOLT FLANGE SH 6*22	2	
90071		90071-MLB0-001	NUT WASH 6MM	NUT WASH 6MM	2	
90201		90201-KHR8-75A	NUT FLANGE 14MM	NUT FLANGE 14MM	1	
90401		90401-KKJ9-001	WASHER THRUST 14*28*2	WASHER THRUST 14*28*2	1	
91309		91309-4E25-004	O-RING 24.4*3.1	O-RING 24.4*3.1	1	
92101		92101-05032-0H	BOLT HEX 5*32	BOLT HEX 5*32	3	
93500-03010		93500-03010-1A	SCREW PAN 3*10 (B)	SCREW PAN 3*10	1	

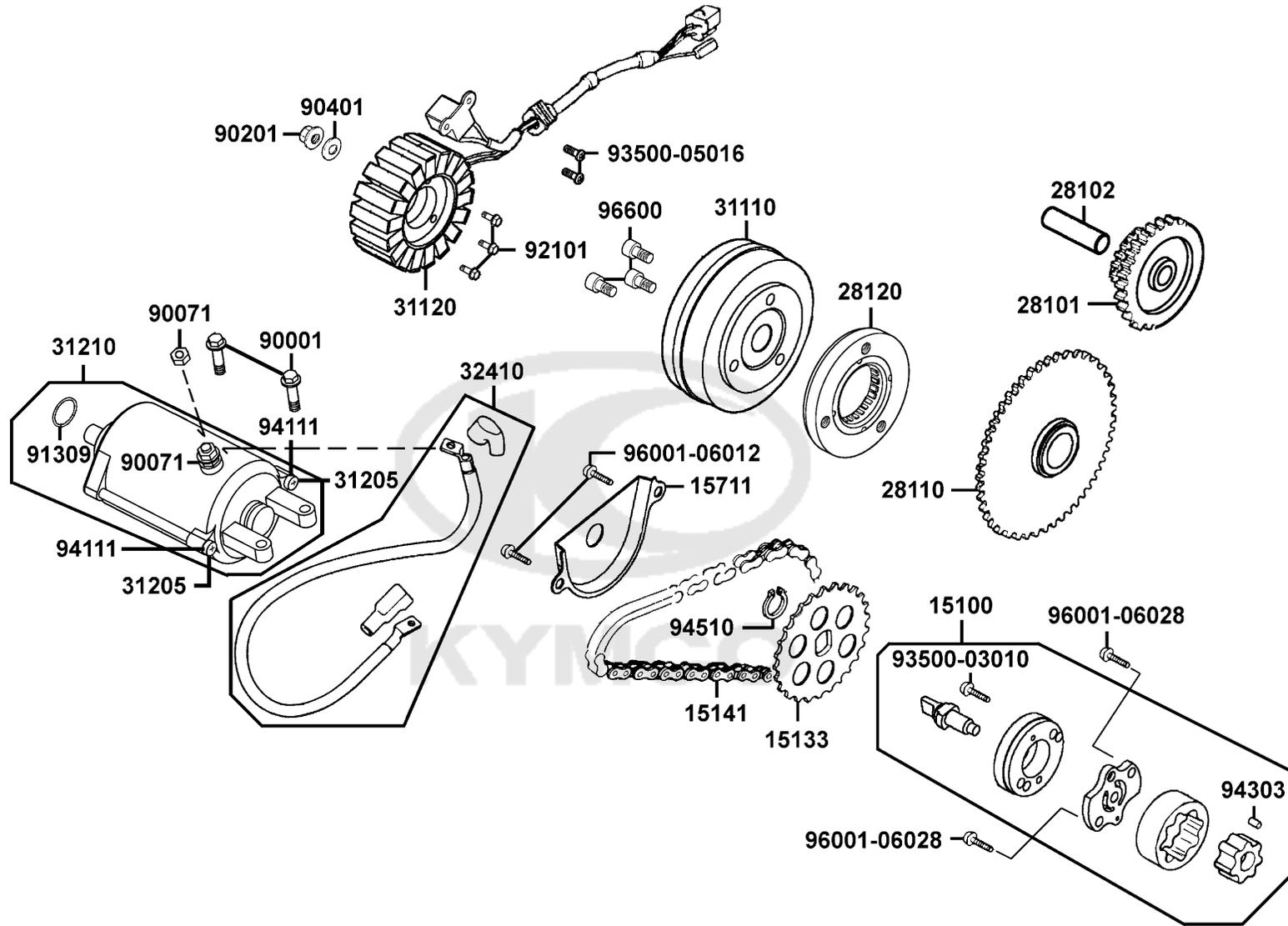

Sales mark	Ref no	Part no	Description	Reg description	Regd no	<b>E06</b>
	93500-05016	93500-05016-0H	SCREW PAN 5*16	SCREW PAN 5*16	2	
	94111	94111-05800	WASHER SPRING 5MM	WASHER SPRING 5MM	2	
	94303	94303-04065	DOWEL PIN 4*6.5	PIN DOWEL 4*6.5	1	
	94510	94510-10000	CIR CLIP EX 10MM	CIR CLIP EX 10MM	1	
	96001-06012	96001-06012-08	BOLT FLANGE 6*12	BOLT FLANGE SH 6*12	2	
	96001-06028	96001-06028-08	BOLT FLANGE SH 6*28	BOLT FLANGE SH 6*28	2	
	96600	96600-08015-10	SOCKET BOLT 8*15	SOCKET BOLT 8*15	3	
						

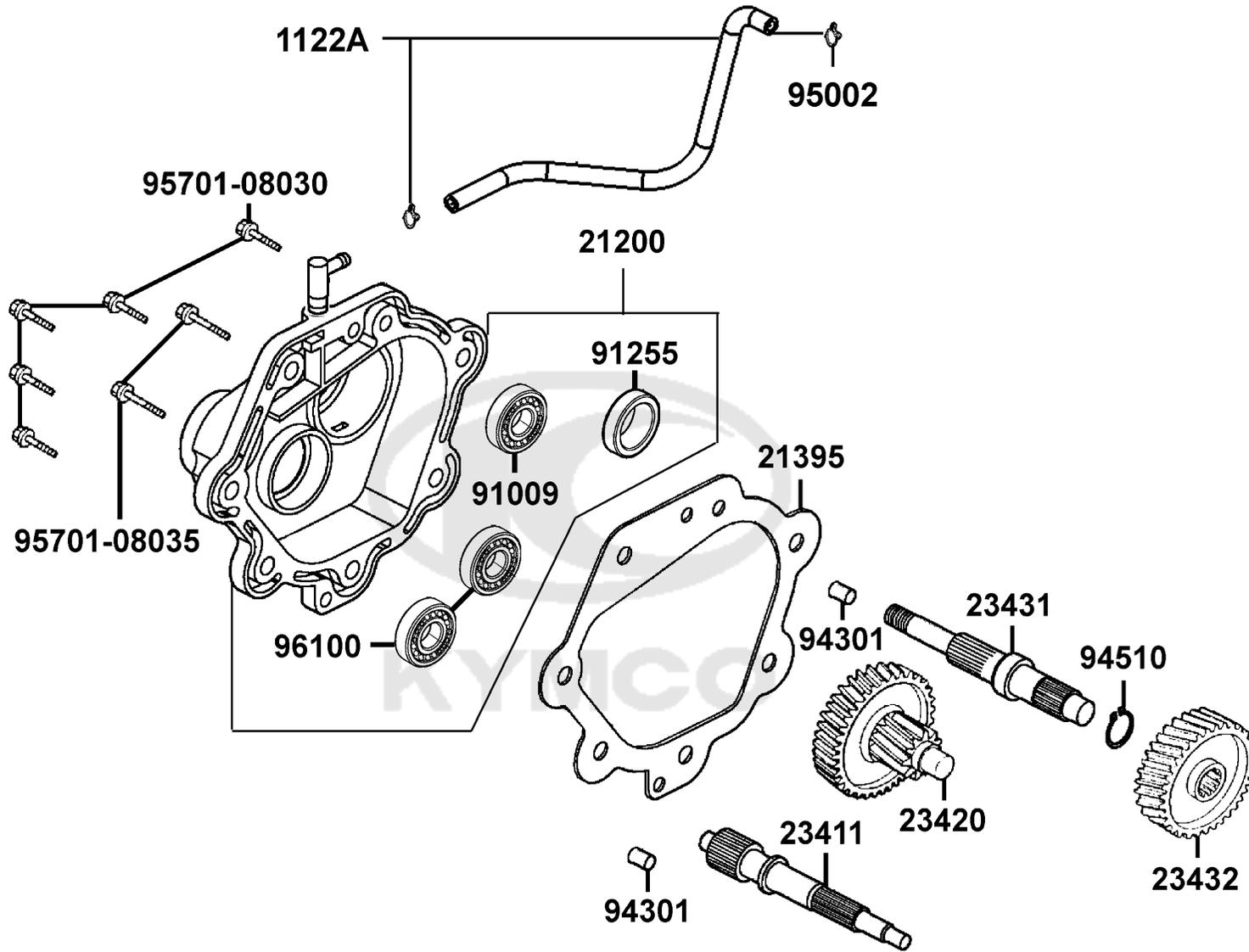

Sales mark	Ref no	Part no	Description	Reg description	Regd no	E07
1122A		1122A-LHG7-E00	TUBE ASSY MISSION BREATHER	TUBE ASSY MISSION BREATHER	1	
21200		21200-KHE7-305	CASE COMP MISSION	CASE COMP MISSION	1	
21395		21395-KHE7-900	GASKET MISSION COVER @ A	GASKET MISSION COVER @ A	1	
23411		23411-KHE7-900	SHAFT DRIVE	SHAFT DRIVE	1	
23420		23420-KHE7-910	SHAFT COMP COUNTER	SHAFT COMP COUNTER	1	
23431		23431-KHE7-900	SHAFT FINAL	SHAFT FINAL	1	
23432		23432-KHE7-910	GEAR FINAL	GEAR FINAL	1	
91009		91009-KHE7-900	BRG BALL RADIAL 6205LLU	BRG BALL RADIAL 6205LLU	1	
91255		91255-KHE7-900	OIL SEAL 34*52*7	OIL SEAL 34*52*7	1	
94301		94301-10160	DOWEL PIN 10*16	DOWEL PIN 10*16	2	
94510		94510-25000	CIR CLIP EXTERNAL 25	CIR CLIP EXTERNAL 25MM	1	
95002		95002-50000	CLIP C9 TUBE	CLIP C9 TUBE	2	
95701-08030		95701-08030-08	BOLT FLANGE 8*30	BOLT FLANGE 8*30	5	
95701-08035		95701-08035-08	BOLT FLANGE 8*35	BOLT FLANGE 8*35	2	
96100		96100-63020-00	BRG BALL RADIAL 6302	BRG BALL RADIAL 6302	2	

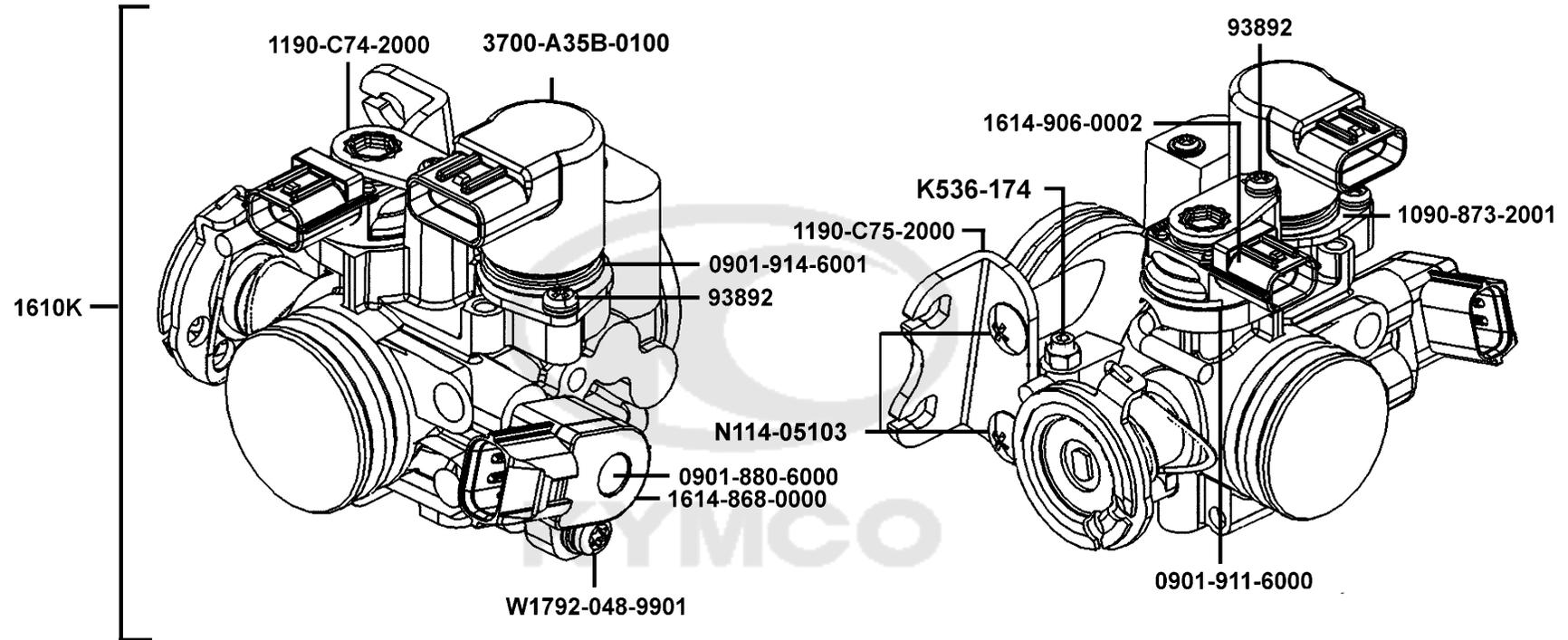

Sales mark	Ref no	Part no	Description	Reg description	Regd no	<b>E08</b>
	0901-880-6000	0901-880-6000	O-RING/TPS	O-RING/TPS	1	
	0901-911-6000	0901-911-6000	O-RING	O-RING	1	
	0901-914-6001	0901-914-6001	O-RING	O-RING	1	
	1090-873-2001	1090-873-2001	SET PLATE	PLATE SET	1	
	1190-C74-2000	1190-C74-2000	STAY PLATE	STAY PLATE	1	
	1190-C75-2000	1190-C75-2000	BRACKET / THROTTLE CABLE	BRACKET / THROTTLE CABLE	1	
	1610K	1610K-LHG7-E00	THROTTLE BODY ASSY	THROTTLE BODY ASSY	1	
	1614-868-0000	1614-868-0000	THROTTLE POSITION SENSER	THROTTLE POSITION SENSER	1	
	1614-906-0002	1614-906-0002	MAP SENSOR	MAP SENSOR	1	
	3700-A35B-0100	3700-A35B-0100	ISC VALVE	ISC VALVE	1	
	93892	93892-04008-18	SCREW WASHER 4*8	SCREW WASHER	1	
	K536-174	K536-174-0200	SCREW SET	SCREW SET	1	
	N114-05103	N114-05103-3	SCREW WASHER	SCREW WASHER	2	
	W1792-048-9901	W1792-048-9901	SCREW TORX M5*0.8/TPS	SCREW TORX M5*0.8/TPS	1	

F01

Head Light

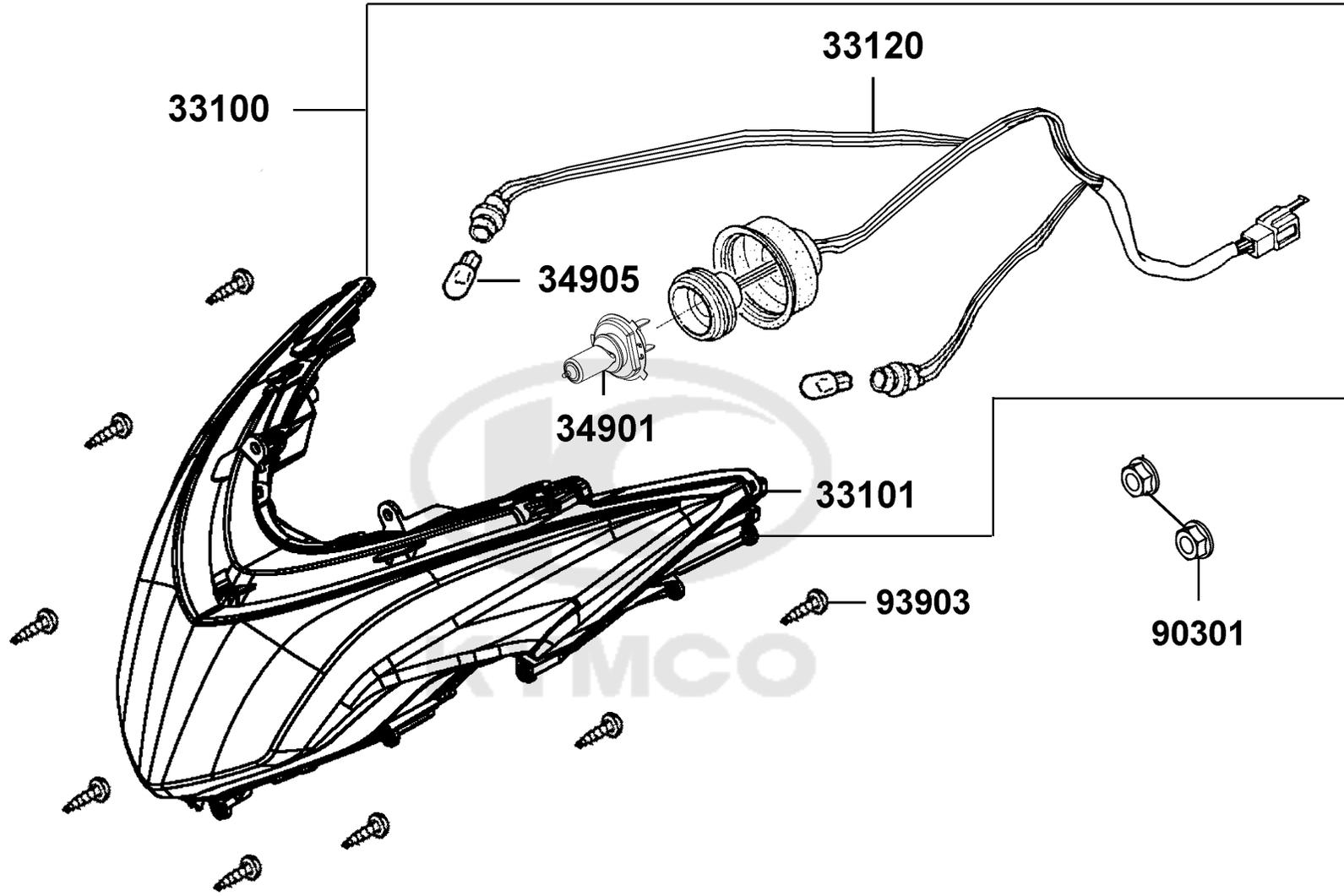



Sales mark	Ref no	Part no	Description	Reg description	Regd no	F01
	33100	33100-LHG7-E00	LIGHT ASS'Y.,FRONT COMB	LIGHT ASS'Y.,FRONT COMB	1	
	33101	33101-LHG7-E00	COMP HEAD LIGHT	COMP HEAD LIGHT	1	
	33120	33120-LHG7-E00	SOCKET COMP HEAD	SOCKET COMP HEAD	1	
	34901	34901-KED9-900	BULB HEAD LIGHT	BULB HEAD LIGHT	1	
	34905	34905-LHG7-E00	BULB 12V WY21W	BULB 12V WY21W	2	
	90301	90301-6D34-671	NUT FLANGE 6MM	NUT FLANGE 6MM	2	
	93903	93903-35260	SCREW TAPPING 5*12	SCREW TAPPING 5*12	8	



F02

Speedometer

37200

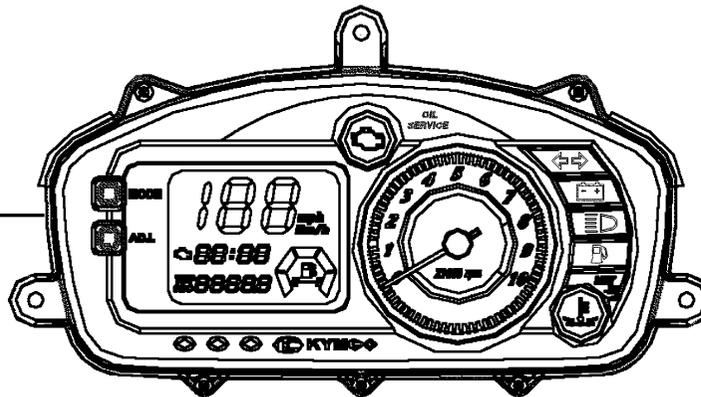

37119

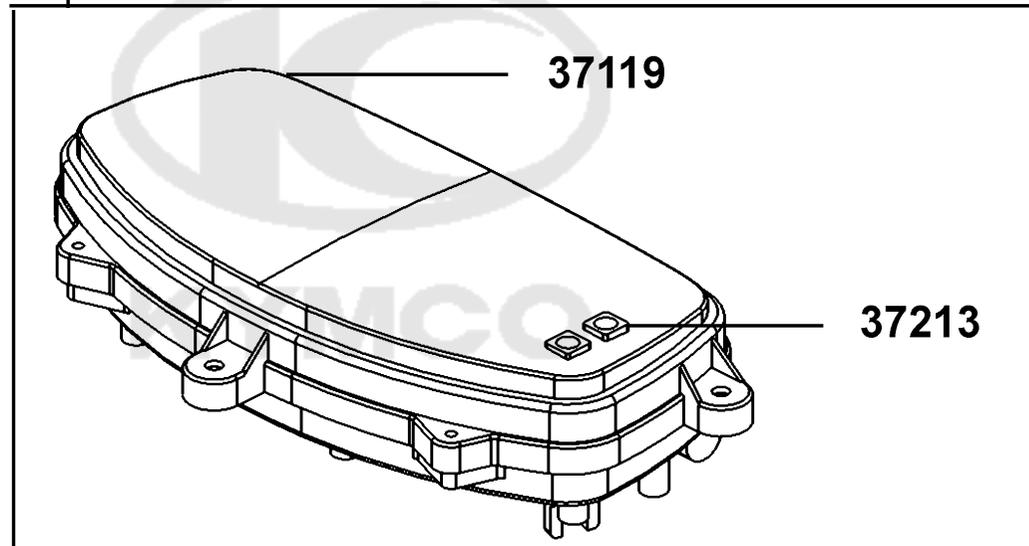

37213

93903



Sales mark	Ref no	Part no	Description	Reg description	Regd no	<b>F02</b>
------------	--------	---------	-------------	-----------------	---------	------------

37119		37119-LEA5-E0A	LENS ASSY	LENS ASSY	1	
37200		37200-LHG7-E0A	METER ASSY SPEED	METER ASSY SPEED	1	
37213		37213-LDA6-90A	PACKING	PACKING	2	
93903		93903-25360	SCREW TAPPING 5*16	SCREW TAPPING 5*16	3	



# Handle SteeringHandle Cover

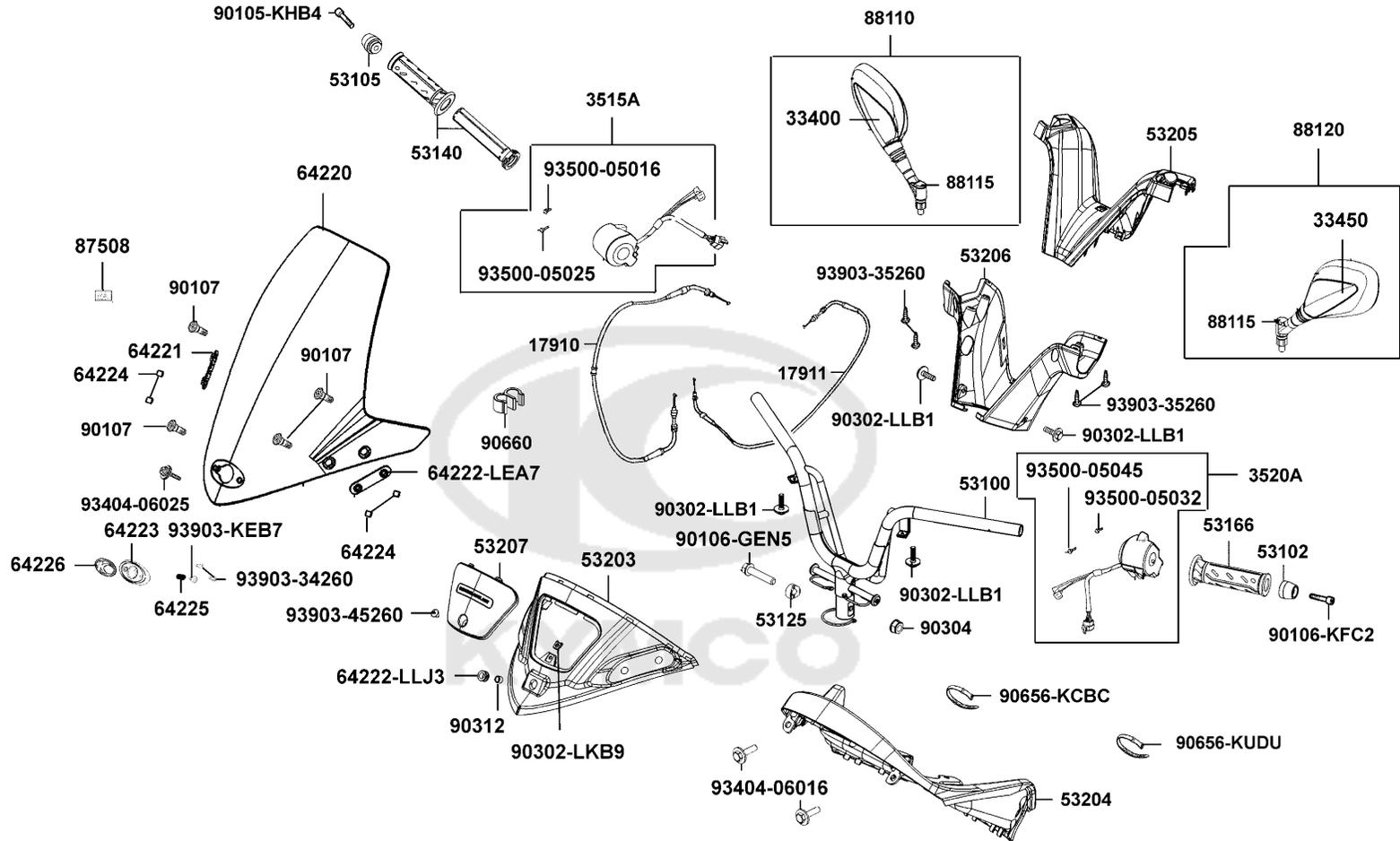

Sales mark	Ref no	Part no	Description	Reg description	Regd no	F03
	17910	17910-LHG7-E00	CABLE A COMP THROT	CABLE A COMP THROT	1	
	17911	17911-LHG7-E00	CABLE B COMP THORT	CABLE B COMP THORT	1	
	33400	33400-LHG7-E00	WINKER ASSY R MIRROR	WINKER ASSY R MIRROR	1	
	33450	33450-LHG7-E00	WINKER ASSY L MIRROR	WINKER ASSY L MIRROR	1	
	3515A	3515A-LHG7-E00	SW. ASSY.. RH. HANDLE COMP.	SW. ASSY.. RH. HANDLE COMP.	1	
	3520A	3520A-LHG7-E00	SW ASSY RH. HANDLE COMP	SW ASSY RH. HANDLE COMP	1	
	53100	53100-LHG7-E00	53100-LHG7-E00	53100-LHG7-E00	1	
**	53102	53102-KEC8-900	END R STRG HANDLE	END R STRG HANDLE	1	
**	53105	53105-LBB5-E00	END R STRG HANDLE	END R STRG HANDLE	1	
	53125	53125-LEA7-E00	COLLAR HANDLE SET	COLLAR HANDLE SET	1	
**	53140	53140-KKC4-900	GRIP COMP THROT	GRIP COMP THROT	1	
**	53166	53166-KGB5-900	GRIP L HANDLE	GRIP L HANDLE	1	
**	53203	53203-LHG7-E00	COVER METER, FR.	COVER METER, FR.	1	
**	53204	53204-LHG7-E00	COVER METER,RR.	COVER METER,RR.	1	
**	53205	53205-LHG7-E00	COVER, HANDLE UP	COVER, HANDLE UP	1	
**	53206	53206-LHG7-E00	COVER, HANDLE LOW	COVER, HANDLE LOW	1	
**	53207	53207-LHG7-E00	COVER, RADIATOR MAINT.	COVER, RADIATOR MAINT.	1	
**	64220	64220-LHG7-E00	WIND SCREEN	WIND SCREEN	1	
	64221	64221-LEA7-E00	RUBBER R WIND SCREEN	RUBBER R WIND SCREEN	1	
	64222-LEA7	64222-LEA7-E00	RUBBER L WIND SCREEN	RUBBER L WIND SCREEN	1	

# Handle SteeringHandle Cover

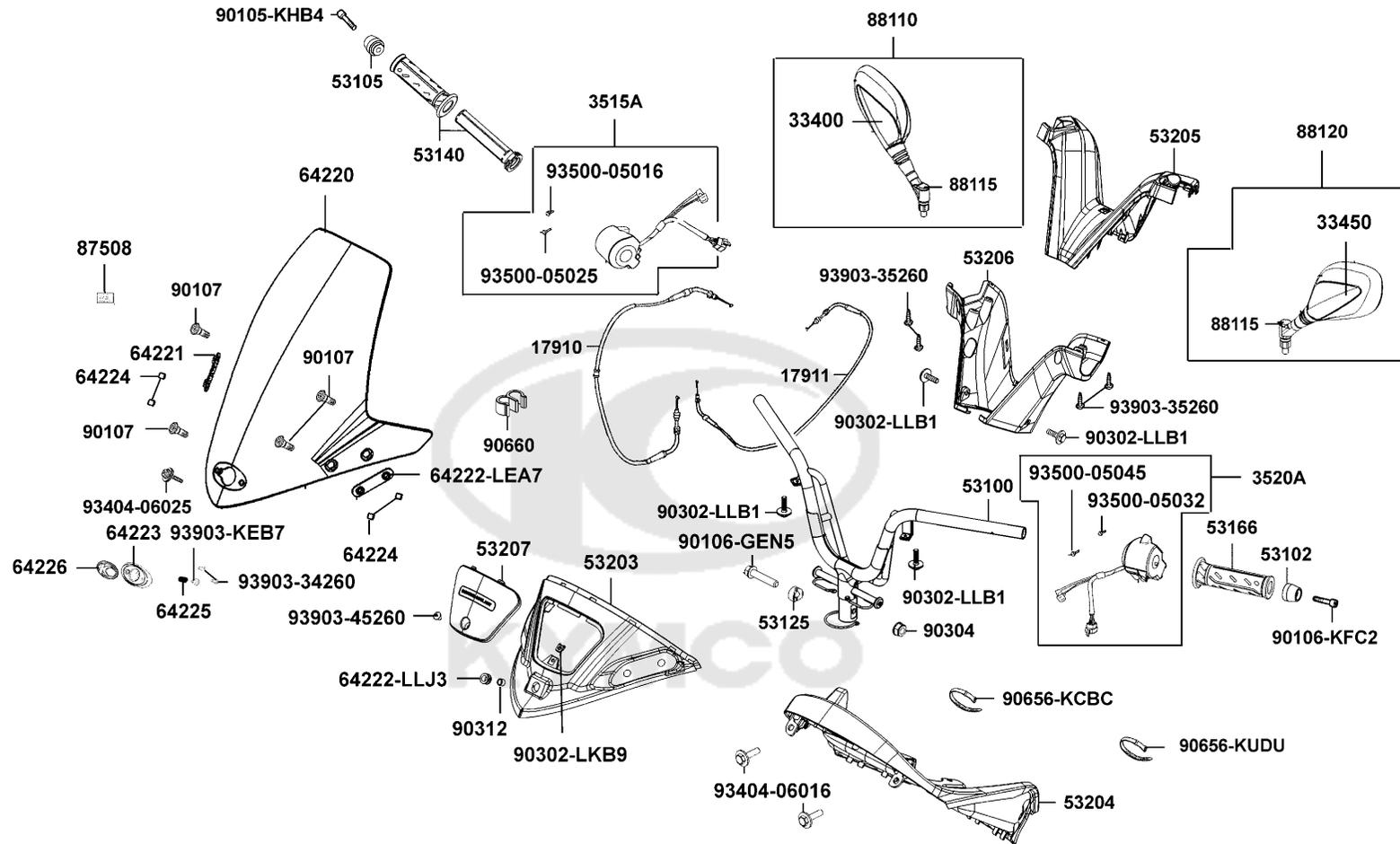

Sales mark	Ref no	Part no	Description	Reg description	Regd no	F03
	64222-LLJ3	64222-LLJ3-E00	RUBBER WIND SCREEN	RUBBER WIND SCREEN	2	
**	64223	64223-LEA7-E00	PLUG WIND SCREEN	PLUG WIND SCREEN	1	
	64224	64224-LEA7-E00	COLLAR WIND SCREEN	COLLAR WIND SCREEN	4	
	64225	64225-LEA7-E00	SPRING COSMETIC K-LOGO	SPRING COSMETIC K-LOGO	1	
	64226	64226-LEA7-E00	COSMETIC K-LOGO	COSMETIC K-LOGO	1	
**	87508	87508-KKC4-E00	LABEL CLEANNESS CAUYION	LABEL CLEANNESS CAUTION	1	
**	88110	88110-LHG7-E00	MIRROR ASSY R BACK	MIRROR ASSY R BACK	1	
**	88115	88115-LBA2-E02	CAP MIRROR BRKT	CAP MIRROR BRKT	2	
**	88120	88120-LHG7-E00	MIRROR ASSY L BACK	MIRROR ASSY L BACK	1	
	90105-KHB4	90105-KHB4-900	BOLT WASH M8*60	BOLT WASH M8*60	1	
	90106-GEN5	90106-GEN5-901	BOLT FLANGE 10*50	BOLT FLANGE 10*50	1	
	90106-KFC2	90106-KFC2-900	BOLT SPECIAL 8MM	BOLT WASH 8MM	1	
	90107	90107-LEA7-E00	BOLT SPECIAL 8MM	BOLT SPECIAL 8MM	4	
	90302-LKB9	90302-LKB9-900	NUT SPRING 5MM	NUT SPRING 5MM	1	
	90302-LLB1	90302-LLB1-E00	BOLT-WASHER 5*12	BOLT WASH 5*12	4	
	90304	90304-GHE8-004	NUT U 10MM	NUT U 10MM	1	
	90312	90312-LLJ3-E00	COLLAR WIND SCREEN	COLLAR WIND SCREEN	1	
	90656-KCBC	90656-KCBC-900	BAND OIL HOSE	BAND OIL HOSE	3	
**	90656-KUDU	90656-KUDU-900	BAND HARNESS WIRE	BAND HARNESS WIRE	1	
	90660	90660-PWA2-900	CLAMP TUBE	CLAMP TUBE	1	

# Handle SteeringHandle Cover

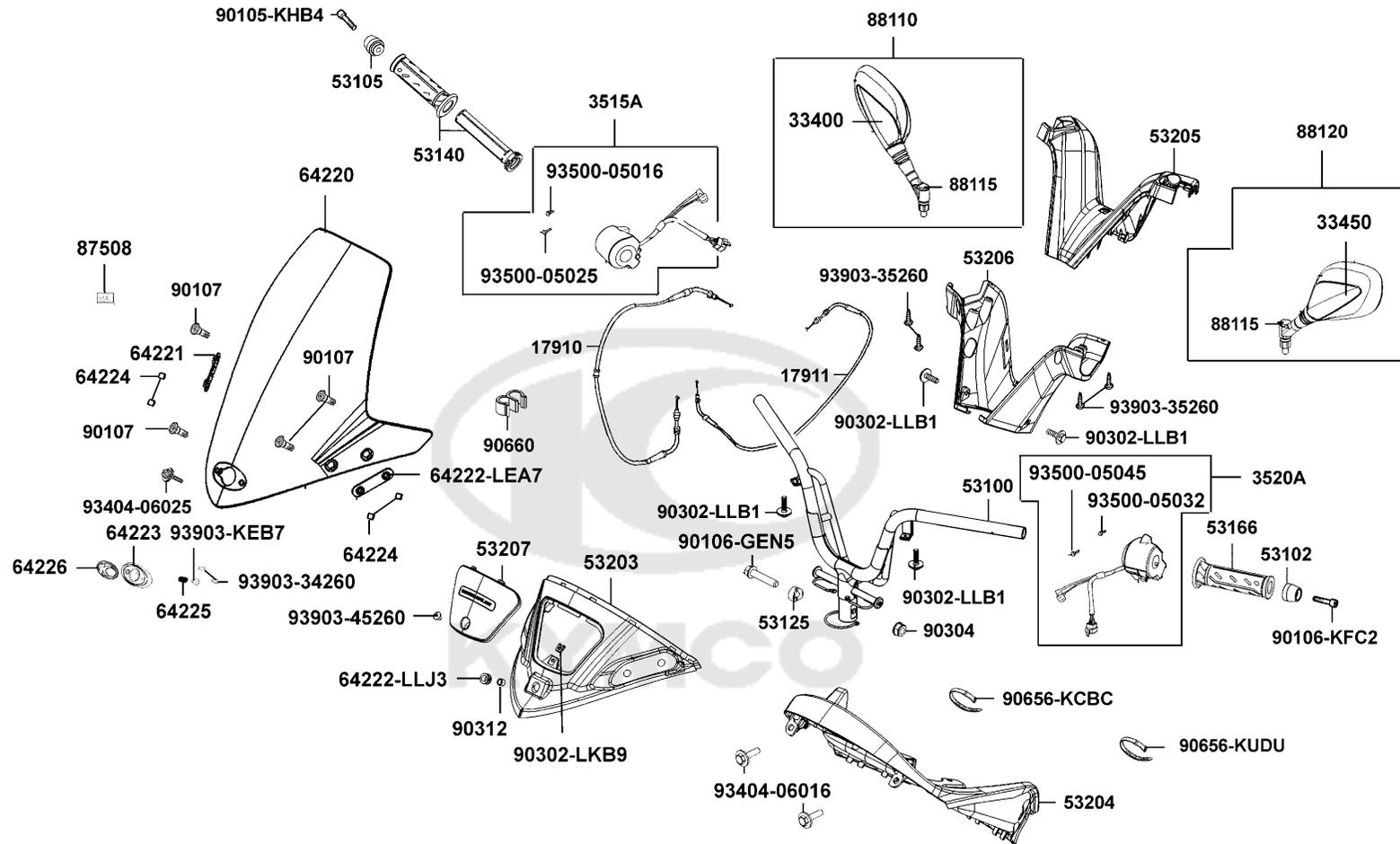



Sales mark	Ref no	Part no	Description	Reg description	Regd no	<b>F03</b>
	93404-06016	93404-06016-06	BOLT WASHER 6*16	BOLT WASHER 6*16	2	
	93404-06025	93404-06025-06	BOLT WASHER 6*25	BOLT WASHER 6*25	1	
	93500-05016	93500-05016-1B	SCREW PAN 5*16	SCREW PAN 5*16	1	
	93500-05025	93500-05025-1B	SCREW PAN 5*25	SCREW PAN 5*25	1	
	93500-05032	93500-05032-1B	SCREW PAN 5*32	SCREW PAN 5*32	1	
	93500-05045	93500-05045-1B	SCREW PAN 5*45	SCREW PAN 5*45	1	
	93903-34260	93903-34260	SCREW TAPPING 4*12	SCREW TAPPING 4*10	2	
	93903-35260	93903-35260	SCREW TAPPING 5*12	SCREW TAPPING 5*12	4	
	93903-45260	93903-45260	SCREW TAPPING 5*12	SCREW TAPPING 5*12	1	
	93903-KEB7	93903-KEB7-900-06	SCREW WASHER 4*12 (G)	SCREW WASHER 4*12	1	





Sales mark	Ref no	Part no	Description	Reg description	Regd no	<b>F04</b>
35340		35340-KNBN-901	SW ASSY FR STOP	SW ASSY FR STOP	1	
35350		35350-KNBN-901	SW ASSY RR STOP	SW ASSY RR STOP	1	
43126		43126-LHG7-E00	HOSE ASSY RR BRK	HOSE ASSY RR BRK	1	
43530		43530-KHD4-305	CYLN SET RR MASTER	CYLN SET RR MASTER	1	
45126		45126-LHG7-E00	HOSE ASSY, M/C FR BRK	HOSE ASSY, M/C FR BRK	1	
45513		45513-KHD4-B00	CAP MASTER CYLINDER	CAP MASTER CYLINDER	2	
45517		45517-KFAF-910	HOLDER M/C	HOLDER M/C	2	
45520		45520-GLW0-91A	DIAPHRAGM	DIAPHRAGM	2	
45530		45530-LHG7-305	CYLINDER SET FR MASTER	CYLINDER SET FR MASTER	1	
53175		53175-LEA5-E00	LEVER R STRG HNDL	LEVER R STRG HNDL	1	
53178		53178-LEA5-E00	LEVER L STRG HNDL	LEVER L STRG HNDL	1	
90114		90114-1F66-007	BOLT HANDLE LEVER	BOLT HANDLE LEVER	2	
90145		90145-MKS9-61A	OIL BOLT 10*22	OIL BOLT 10*22	4	
90545		90545-3L00-001	WASHER OIL BOLT	WASHER OIL BOLT	8	
93600		93600-04012-1G	SCREW FLAT 4*12	SCREW FLAT 4*12	4	
93893		93893-04012-18	SCREW WASHER 4*12	SCREW WASHER 4*12	2	
94050-06060		94050-06060	NUT FLANGE 6MM	NUT FLANGE 6MM	2	
96001-06022		96001-06022-06	BOLT FLANGE SH 6*22 (G)	BOLT FLANGE SH 6*22 (G)	4	

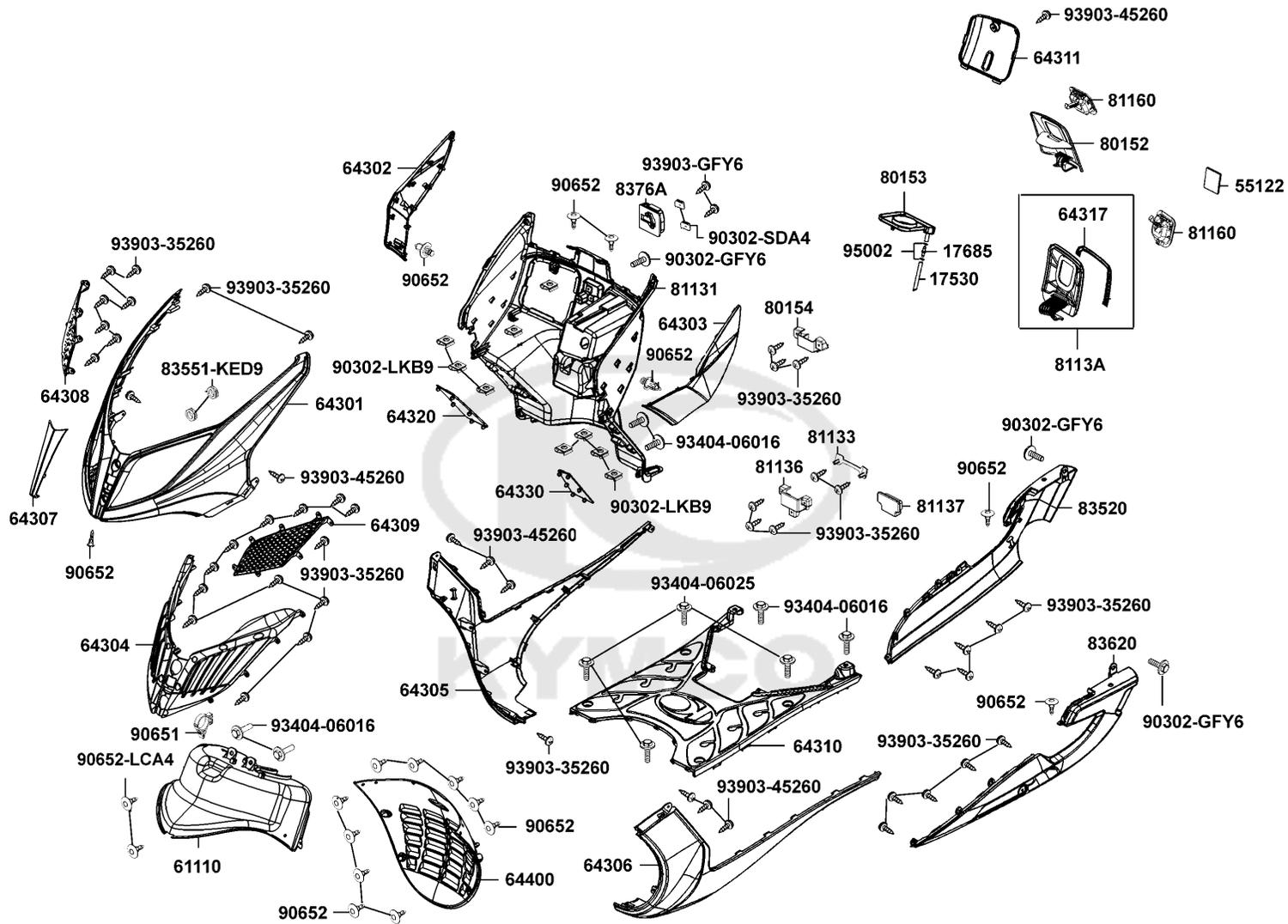

Sales mark	Ref no	Part no	Description	Reg description	Regd no	F05
	17530	17530-LHG7-E00	TUBE ASSY.,FUEL DRAIN	TUBE ASSY.,FUEL DRAIN	1	
	17685	17685-KZCZ-900	JOINT TUBE	JOINT TUBE	1	
	55122	55122-LHG7-E00	PLUG FUEL TANK MAINT	PLUG FUEL TANK MAINT	1	
**	61110	61110-LHG7-E00	FENDER FR INNER	FENDER FR INNER	1	
**	64301	64301-LHG7-E00	COVER FR.	COVER FR.	1	
**	64302	64302-LHG7-E00	MOLD FR.,R/H	MOLD FR.,R/H	1	
**	64303	64303-LHG7-E00	MOLD FR.,L/H	MOLD FR.,L/H	1	
**	64304	64304-LHG7-E00	TOP COVER,FR.	TOP COVER,FR.	1	
**	64305	64305-LHG7-E00	SKIRT R., SID	SKIRT R., SID	1	
**	64306	64306-LHG7-E00	SKIRT L., SIDE	SKIRT L., SIDE	1	
**	64307	64307-LHG7-E00	OUTER,FR. COVER	OUTER,FR. COVER	1	
**	64308	64308-LHG7-E00	GRILL,R/H.,FR COVER	GRILL,R/H.,FR COVER	1	
**	64309	64309-LHG7-E00	GRILL,L/H.,FR COVER	GRILL,L/H.,FR COVER	1	
**	64310	64310-LHG7-E00	FLOOR, PANEL	FLOOR, PANEL	1	
**	64311	64311-LHG7-E00	LID RESERVE TANK	LID RESERVE TANK	1	
	64317	64317-LHG7-E00	SEAL,INNER BOX UP	SEAL,INNER BOX UP	1	
	64320	64320-LHG7-E00	MAT,LEG SHIELD R/H	MAT,LEG SHIELD R/H	1	
	64330	64330-LHG7-E00	MAT,LEG SHIELD L/H	MAT,LEG SHIELD L/H	1	
**	64400	64400-LHG7-E00	COWL UNDER	COWL UNDER	1	
**	80152	80152-LHG7-E00	LID,FUEL TANK MAINT.	LID,FUEL TANK MAINT.	1	



Sales mark	Ref no	Part no	Description	Reg description	Regd no	F05
**	80153	80153-LEA7-E00	RUBBER FUEL CAP	RUBBER FUEL CAP	1	
**	80154	80154-LHG7-E00	COVER,FUEL CAP,LID	COVER,FUEL CAP,LID	1	
**	81131	81131-LHG7-E00	LEG SHIELD	LEG SHIELD	1	
**	81133	81133-LHG7-E00	RETAIN PLATE,INNERBOX	RETAIN PLATE,INNERBOX	1	
**	81136	81136-LHG7-E00	CASE, FR INNER BOX	CASE, FR INNER BOX	1	
	81137	81137-LHG7-E00	PLUG INNER BOX	PLUG INNER BOX	1	
**	8113A	8113A-LHG7-E00	LID ASSY INNER BOX	LID ASSY INNER BOX	1	
	81160	81160-LHG7-E00	LOCK ASSY.,FR INNER BOX	LOCK ASSY.,FR INNER BOX	2	
**	83520	83520-LHG7-E00	MOLD,R SIDE	MOLD,R SIDE	1	
	83551-KED9	83551-KED9-900	GROMMET COVER	GROMMET COVER	2	
**	83620	83620-LHG7-E00	MOLD, L SIDE	MOLD, L SIDE	1	
	8376A	8376A-KEBE-900	CLIP ASSY CENTER	CLIP ASSY CENTER	1	
	90302-GFY6	90302-GFY6-901	BOLT WASH 5*12	BOLT- WASHER 5*12	3	
	90302-LKB9	90302-LKB9-900	NUT SPRING 5MM	NUT SPRING 5MM	9	
	90302-SDA4	90302-SDA4-004	NUT SPRING 4MM	NUT SPRING 4MM	2	
	90651	90651-LGM9-900	CLIP CABLE	CLIP CABLE	1	
	90652-LCA4	90652-LCA4-E00	CLIP MUDGUARD	CLIP MUDGUARD	2	
	90652	90652-LFB5-900	CLIP MUDGUARD	CLIP MUDGUARD	17	
	93404-06016	93404-06016-06	BOLT WASHER 6*16	BOLT WASHER 6*16	6	
	93404-06025	93404-06025-06	BOLT WASHER 6*25	BOLT WASHER 6*25	4	

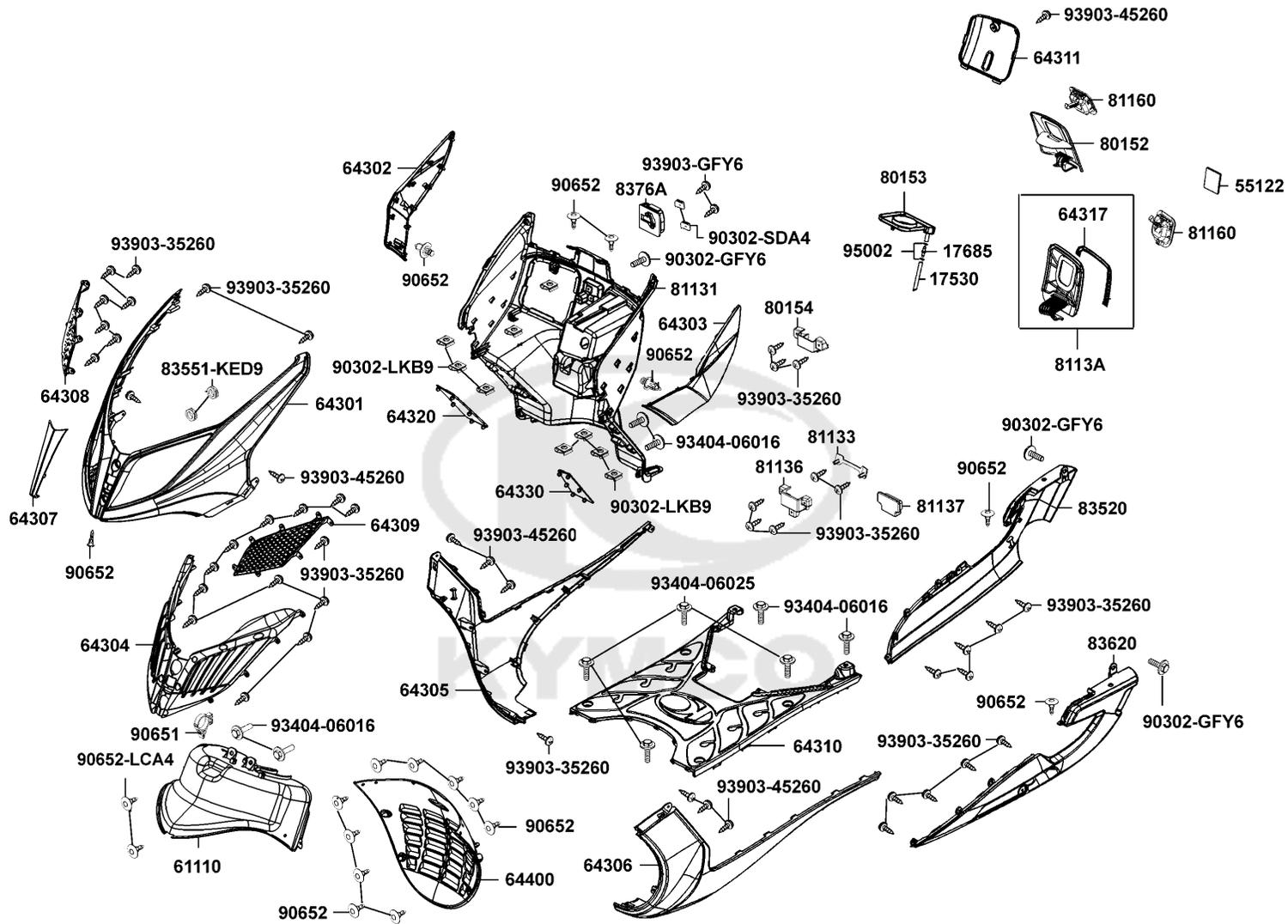



Sales mark	Ref no	Part no	Description	Reg description	Regd no	<b>F05</b>
------------	--------	---------	-------------	-----------------	---------	------------

	93903-35260	93903-35260	SCREW TAPPING 5*12	SCREW TAPPING 5*12	41	
	93903-45260	93903-45260	SCREW TAPPING 5*12	SCREW TAPPING 5*12	9	
	93903-GFY6	93903-GFY6-900	SCREW TAPPING 4*14	SCREW TAPPING 4*14	2	
	95002	95002-02080	CLIP B8 TUBE	CLIP B8 TUBE	2	



F06

Front Cushion

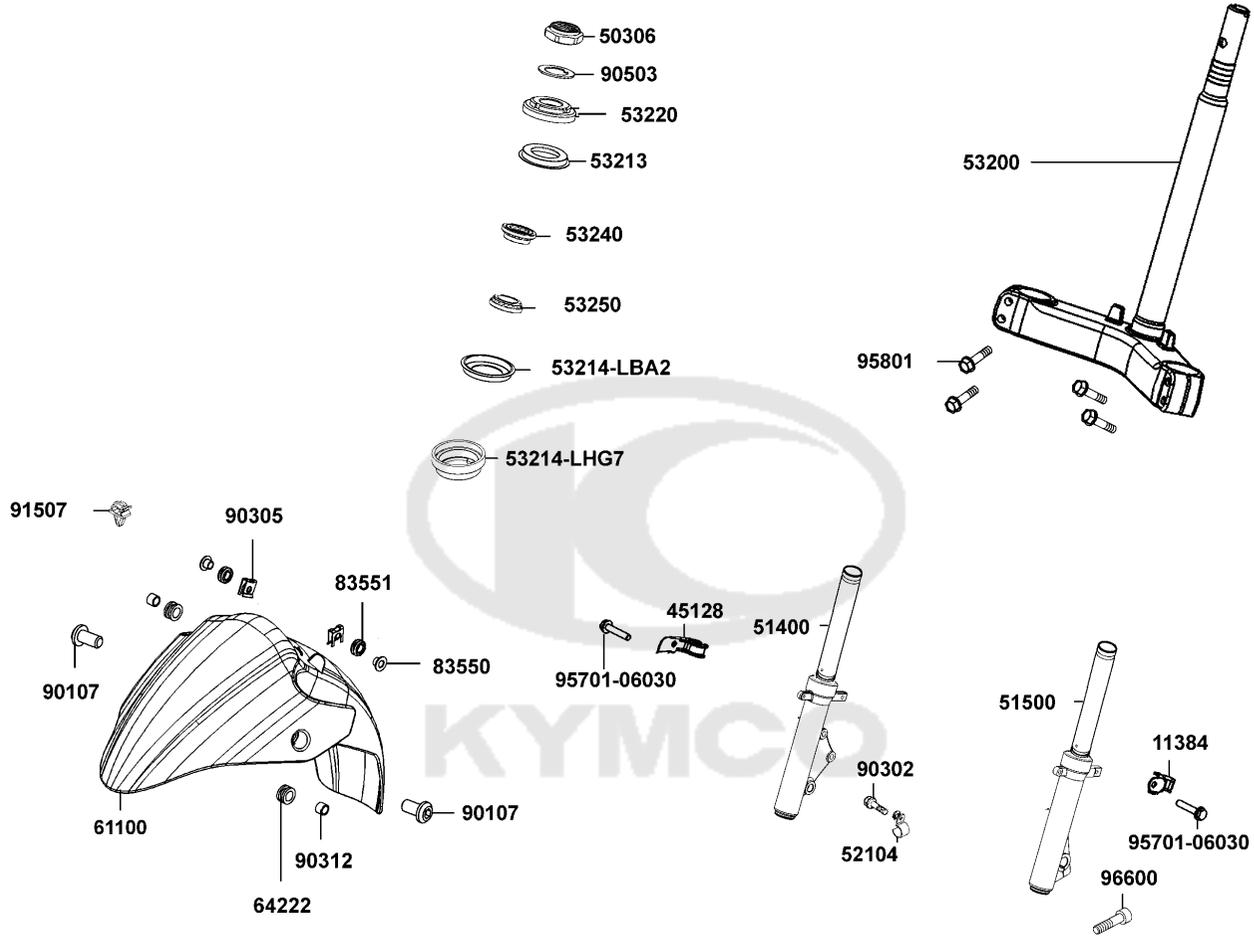

Sales mark	Ref no	Part no	Description	Reg description	Regd no	F06
	11384	11384-KUDU-900	CLAMPER BREATHER TUBE	CLAMPER BREATHER TUBE	1	
	45128	45128-LHG7-E00	CLIP FRONT FORK	CLIP FRONT FORK	1	
	50306	50306-1F96-001	NUT STRG STEM LOCK	NUT STRG STEM LOCK	1	
**	51400	51400-LHG7-E00	FORK ASSY, FR R	FORK ASSY, FR R	1	
**	51500	51500-LHG7-E00	FORK ASSY, FR L	FORK ASSY, FR L	1	
	52104	52104-LGE5-E01	STAY A, RR SENSOR	STAY A, RR SENSOR	1	
	53200	53200-LKG3-E00	STEM COMP STEERING	STEM COMP STEERING	1	
	53213	53213-LBA2-E00	DUST SEAL STRG HEAD TOP	DUST SEAL STRG HEAD TOP	1	
	53214-LBA2	53214-LBA2-E00	DUST SEAL STRG (HEAD)	DUST SEAL STRG (HEAD)	1	
	53214-LHG7	53214-LHG7-E00	DUST SEAL STRG HEAD BOT	DUST SEAL STRG HEAD BOT	1	
	53220	53220-LBA2-E00	THREAD COMP STRG HEAD TOP	THREAD COMP STRG HEAD TOP	1	
	53240	53240-LBA2-E00	BEARING TOT STRG	BEARING TOT STRG	1	
	53250	53250-LBA2-E00	BEARING BOT STRG	BEARING BOT STRG	1	
**	61100	61100-LHG7-E00	FENDER FRONT	FENDER FRONT	1	
	64222	64222-LLJ3-E00	RUBBER WIND SCREEN	RUBBER WIND SCREEN	2	
	83550	83550-KEC8-900	COLLAR	COLLAR	2	
	83551	83551-KEC8-900	GROMMET COVER	GROMMET COVER	2	
	90107	90107-LEA7-E00	BOLT SPECIAL 8MM	BOLT SPECIAL 8MM	2	
	90302	90302-LBF2-900	BOLT-WASH M5*10	BOLT-WASH M5*10	1	
	90305	90305-LBA2-E00	NUT CLIP 6MM	NUT CLIP 6MM	2	

F06

Front Cushion

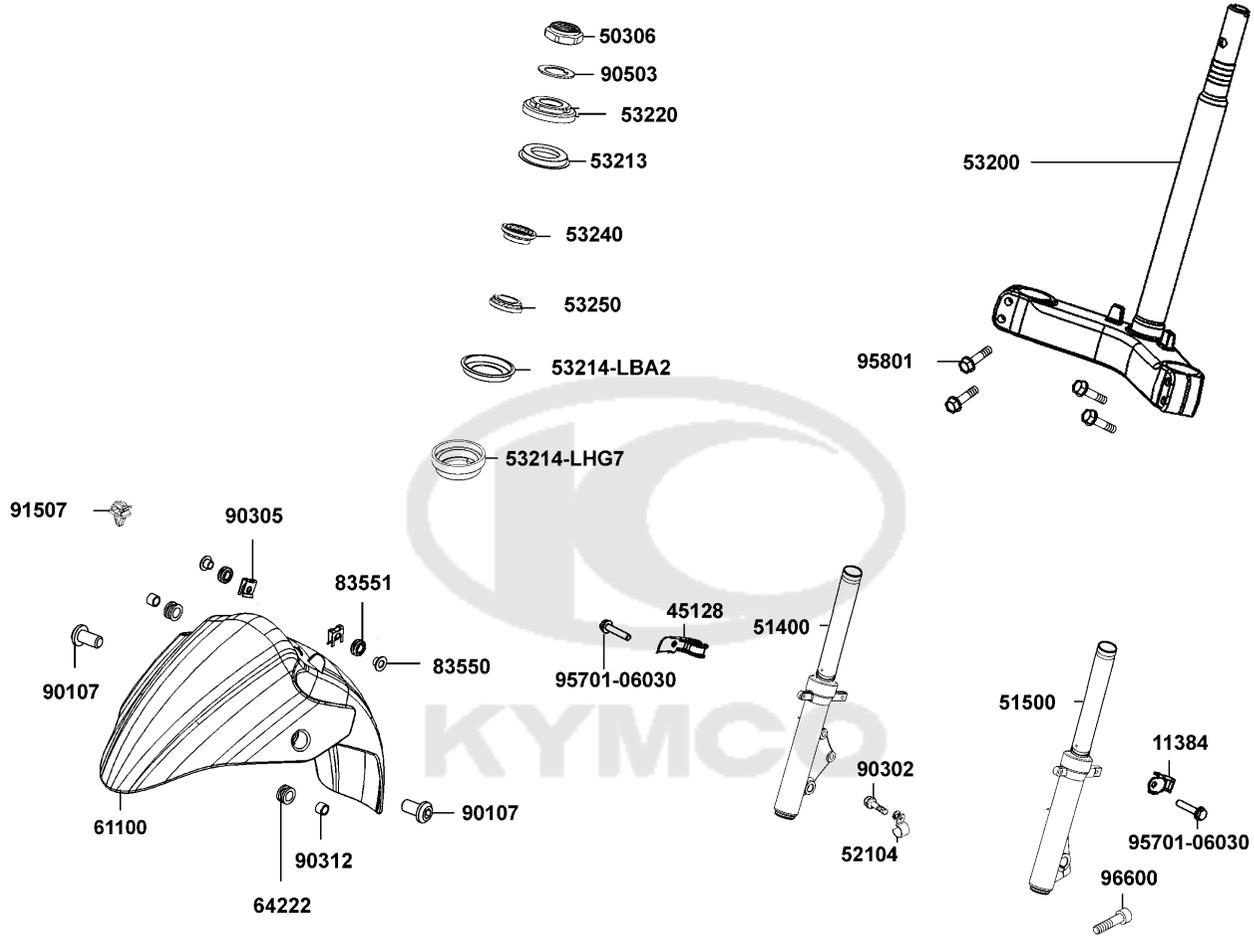

Sales mark	Ref no	Part no	Description	Reg description	Regd no	<b>F06</b>
------------	--------	---------	-------------	-----------------	---------	------------

90312		90312-LLJ3-E01	COLLAR WIND SCREEN	COLLAR WIND SCREEN	2	
90503		90503-LEA7-E00	WASHER STRG STEM NUT	WASHER STRG STEM NUT	1	
91507		91507-LKE6-900	CLIP	CLIP	1	
95701-06030		95701-06030-06	BOLT FLANGE 6*30 (G)	BOLT FLANGE 6*30	2	
95801		95801-08040-06	BOLT FLANGE 8*40	BOLT FLANGE 8*40	4	
96600		96600-08025-06	SOCKET BOLT 8*25	SOCKET BOLT 8*25	1	



F07

Front Wheel

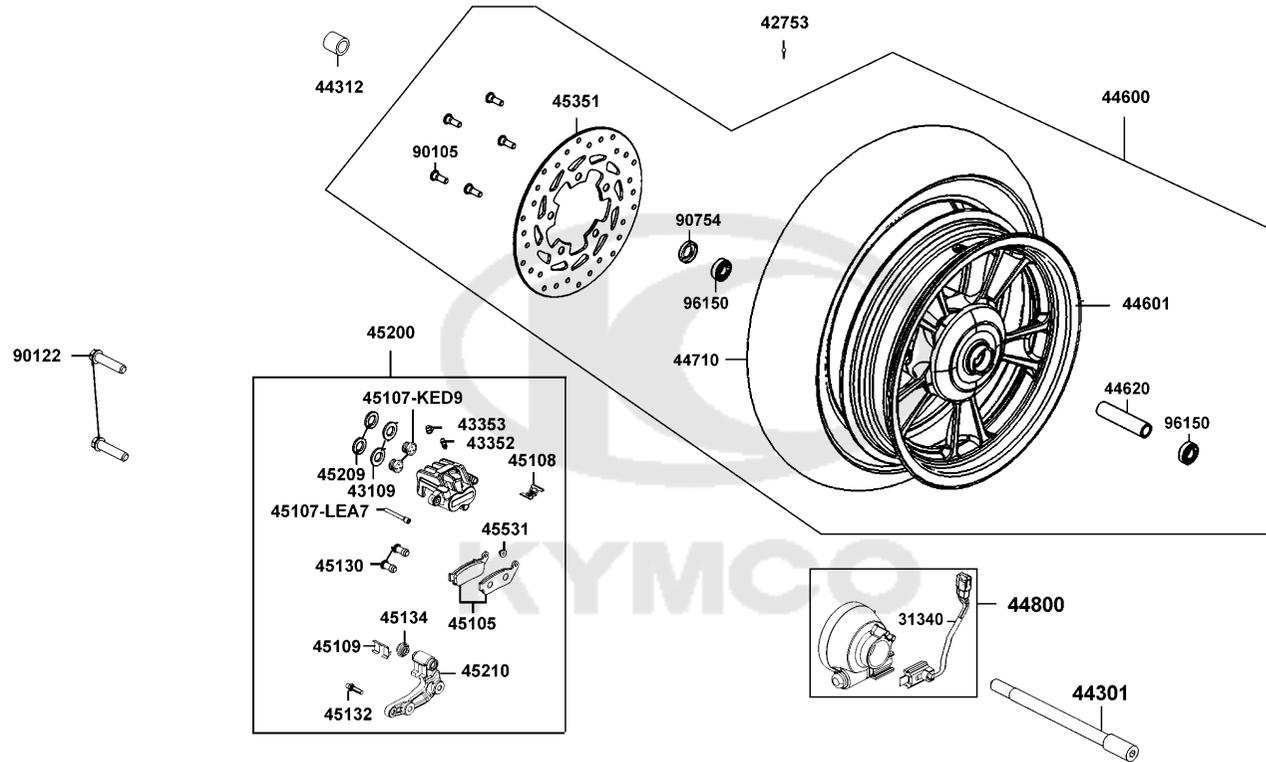

Sales mark	Ref no	Part no	Description	Reg description	Regd no	F07
	31340	31340-LHG7-E00	SPEED SENSOR	SPEED SENSOR	1	
	42753	42753-KNBN-90B	VALAE RIM (TR412)	VALAE RIM (TR412)	1	
	43109	43109-MCA3-007	SEAL PISTON	SEAL PISTON	2	
	43352	43352-KED9-900	BLEEDER	BLEEDER	1	
	43353	43353-KED9-900	CAP BLEEDER	CAP BLEEDER	1	
	44301	44301-LLJ3-E00	AXLE FR WHEEL	AXLE FR WHEEL	1	
	44312	44312-LGE5-E00	COLLAR FR AXLE SIDE A	COLLAR FR AXLE SIDE A	1	
**	44600	44600-LHG7-305	WHEEL SET FR	WHEEL SET FR	1	
**	44601	44601-LHG7-E00	WHEEL, FR CAST	WHEEL, FR CAST	1	
	44620	44620-LLJ3-E00	COLLAR FR AXLE DIST	COLLAR FR AXLE DIST	1	
	44710	44710-LEA5-E00	TIRE ASSY FR /MAXXIS	TIRE ASSY FR /MAXXIS	1	
	44800	44800-LHG7-E00	GEAR BOX ASSY	GEAR BOX ASSY	1	
	45105	45105-LEA7-305	PAD SET	PAD SET	1	
	45107-KED9	45107-KED9-900	PISTON	PISTON	2	
	45107-LEA7	45107-LEA7-E00	PIN HANGER	PIN HANGER	1	
	45108	45108-LEA7-E00	SPRING PAD	SPRING PAD	1	
	45109	45109-KED9-900	SLIDE PAD	SLIDE PAD	1	
	45130	45130-KED9-900	BUSH PIN	BUSH PIN	2	
	45132	45132-KED9-900	PIN BOLT	PIN BOLT	1	
	45134	45134-KED9-900	BOOT B	BOOT B	1	

F07

Front Wheel

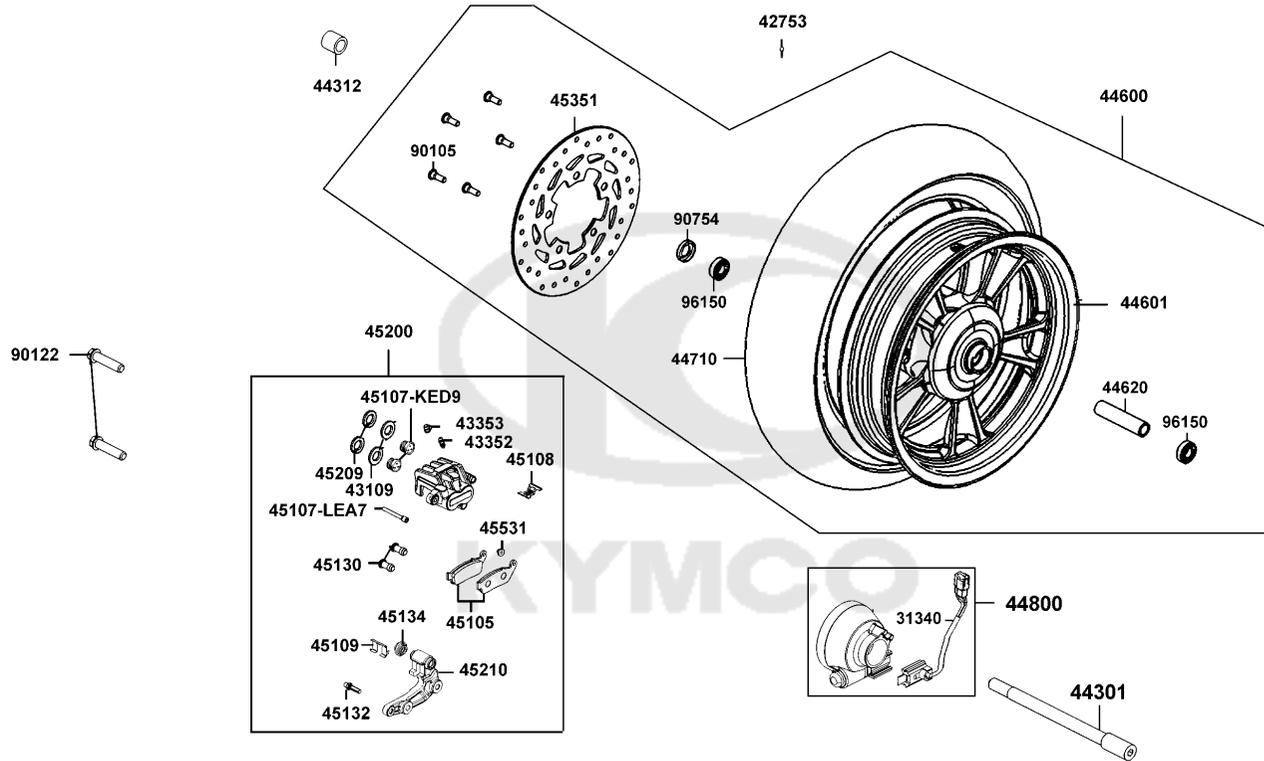



Sales mark	Ref no	Part no	Description	Reg description	Regd no	<b>F07</b>
**	45200	45200-LEA7-E00	CALIPER ASSY. FR	CALIPER ASSY. FR	1	
	45209	45209-KED9-900	DUST SEAL	DUST SEAL	2	
	45210	45210-LEA7-E00	BRACKET FR	BRACKET FR	1	
**	45351	45351-LEA5-E00	DISK FR BRAKE	DISK FR BRAKE	1	
	45531	45531-KED9-900	PLUG	PLUG	2	
	90105	90105-KCR3-001	BOLT FR DISK 8*24	BOLT FR DISK 8*24	10	
	90122	90122-LEA7-E00	BOLT FLANGE 10x42(Cr)	BOLT FLANGE 10x42(Cr)	2	
	90754	90754-LLJ3-E00	DUST SEAL	DUST SEAL	1	
	96150	96150-60020-10	BEARING BALL RADIAL 6002	BEARING BALL RADIAL 6002	2	

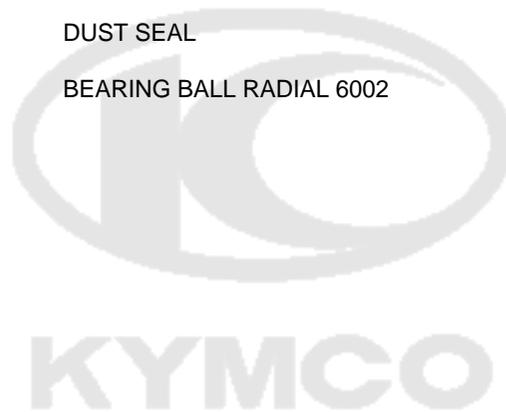

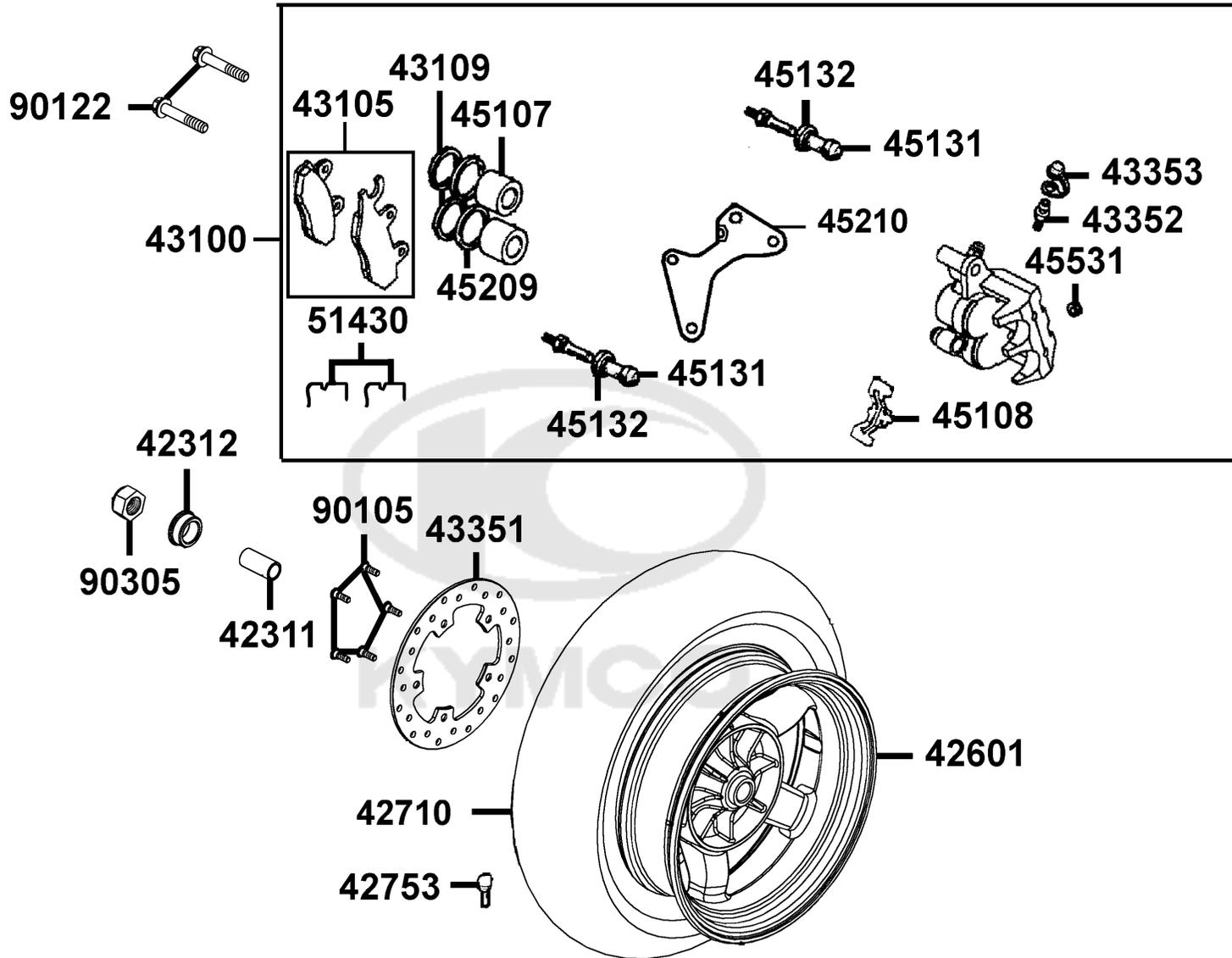

Sales mark	Ref no	Part no	Description	Reg description	Regd no	F08
	42311	42311-KHE7-E00	COLLAR RR AXLE A	COLLAR RR AXLE A	1	
	42312	42312-KHE7-E00	COLLAR RR AXLE SIDE	COLLAR RR AXLE SIDE	1	
**	42601	42601-LHG7-E01	WHEEL RR CAST	WHEEL RR CAST	1	
	42710	42710-KKC2-E00	TIRE ASSY RR (140/70-12) /CHENG SHIN	TIRE ASSY RR (140/70-12) /CHENG SHIN	1	
	42753	42753-KNBN-90B	VALAE RIM (TR412)	VALAE RIM (TR412)	1	
**	43100	43100-LHG7-E00	CALIPER ASSY., RR.	CALIPER ASSY., RR.	1	
	43105	43105-LHG7-305	PAD SET	PAD SET	1	
	43109	43109-GBN2-007	DUST SEAL	DUST SEAL	2	
	43351	43351-LFB5-900	DISK FR BRAKE	DISK BRAKE RR	1	
	43352	43352-KKD6-E90	SCREW BLEEDER	SCREW BLEEDER	1	
	43353	43353-4A61-77A	CAP BLEEDER	CAP BLEEDER	1	
	45107	45107-MEN5-007	PISTON	PISTON	2	
	45108	45108-LDH1-E00	SPRING PAD	SPRING PAD	1	
	45131	45131-LDH1-E00	PIN BOLT	PIN BOLT	2	
	45132	45132-LDH1-E00	BUSH BOOT PIN	BUSH BOOT PIN	2	
	45209	45209-GBN2-007	SEAL PISTON	SEAL PISTON	2	
**	45210	45210-LDF2-E00	BRACKET FR CALIPER	BRACKET FR CALIPER	1	
	45531	45531-GAR1-951	PLUG	PLUG	1	
	51430	51430-LDH1-E00	SLIDE PAD	SLIDE PAD	2	
	90105	90105-KCR3-001	BOLT FR DISK 8*24	BOLT FR DISK 8*24	5	

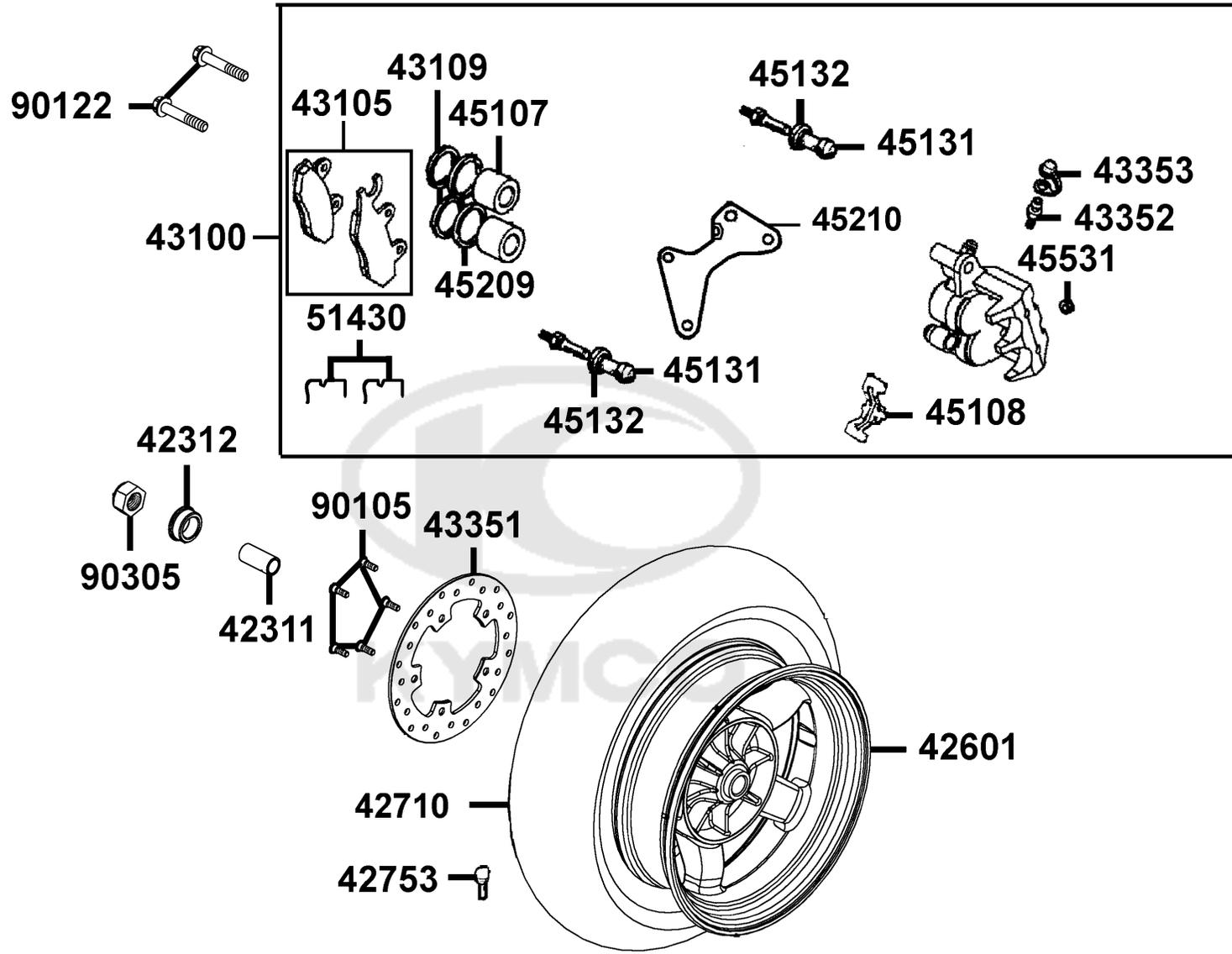

Sales mark	Ref no	Part no	Description	Reg description	Regd no	<b>F08</b>
------------	--------	---------	-------------	-----------------	---------	------------

90122	90122-LHG7-E00	90122-LHG7-E00	BOLT FLANGE 8x38(G)	BOLT FLANGE 8x38(G)	2	
90305	90305-KFW6-91A	90305-KFW6-91A	NUT U 16MM	NUT U 16MM	1	



F09

Seat

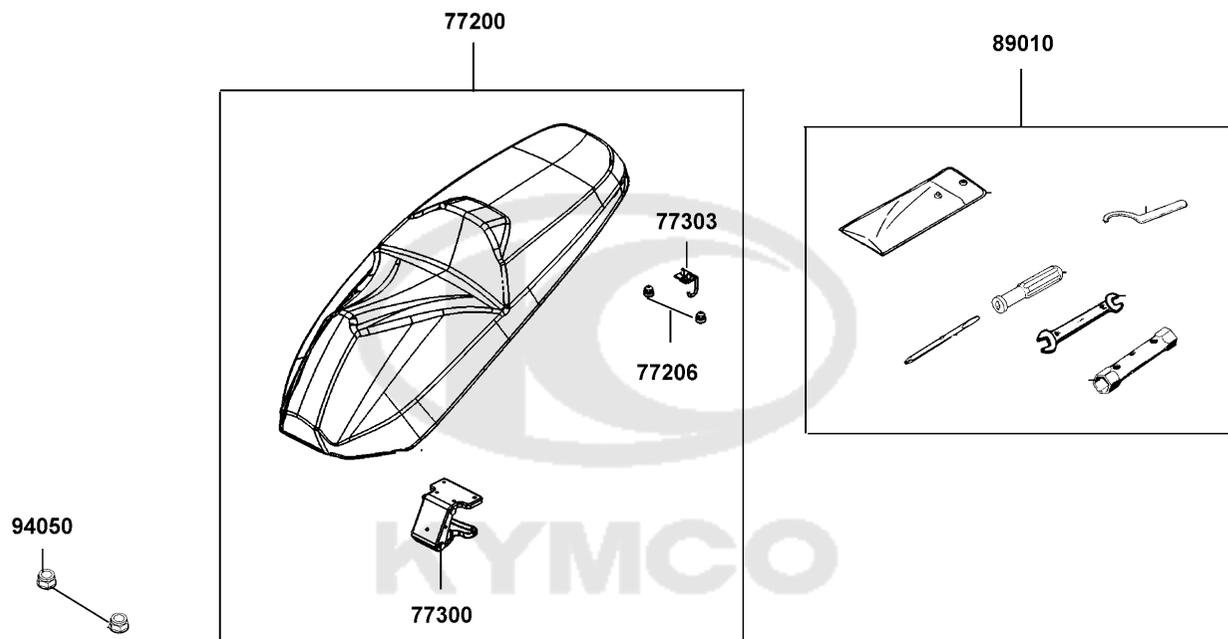

Sales mark	Ref no	Part no	Description	Reg description	Regd no	<b>F09</b>
------------	--------	---------	-------------	-----------------	---------	------------

**	77200	77200-LHG7-E00	SEAT, ASSY.	SEAT, ASSY.	1	
	77206	77206-KEB7-900	RUBBER SEAT CUSH	RUBBER SEAT CUSH	2	
	77300	77300-LHG8-E00	HINGE ASSY SEAT	HINGE ASSY SEAT	1	
	77303	77303-LCD3-E00	HOOK SEAT LOCK	HOOK SEAT LOCK	2	
	89010	89010-LHG7-E00	TOOL SET	TOOL SET	1	
	94050	94050-06080	NUT FLANGE 6MM	NUT FLANGE 6MM	2	



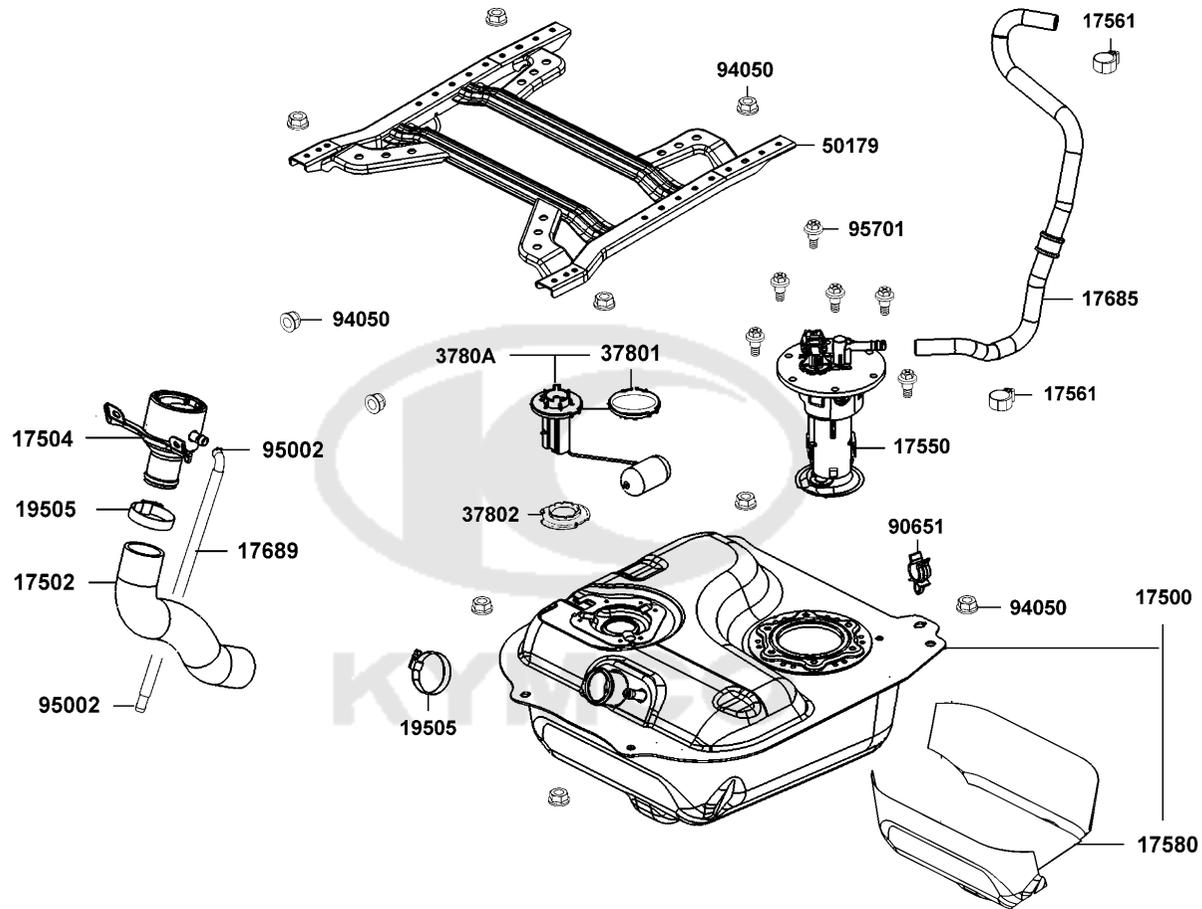



Sales mark	Ref no	Part no	Description	Reg description	Regd no	<b>F10</b>
17500		17500-LHG7-E00	TANK COMP.,FUEL		1	
17502		17502-LHG7-E00	HOSE,FUEL	HOSE,FUEL	1	
17504		17504-LHG7-E00	METAL COMP. ,FUEL FILLER	METAL COMP. ,FUEL FILLER	1	
17550		17550-LGE5-E00	FUEL PUMP ASSY	FUEL PUMP ASSY	1	
17561		17561-LKB9-900	CLIP 12.5	CLIP 12.5	2	
17580		17580-LHG7-E00	HEAT GUARD FUEL TANK	HEAT GUARD FUEL TANK	2	
17685		17685-LHG7-E00	TUBE FUEL PUMP	TUBE FUEL PUMP	1	
17689		17689-LHG7-E00	TUBE ASSY,TANK-FILLER	TUBE ASSY,TANK-FILLER	1	
19505		19505-LEA2-900	CLAMP HOSE	CLAMP HOSE	2	
37801		37801-GGA7-701	PACKING BASE	PACKING BASE	1	
37802		37802-GGA7-701	RET FUEL UNIT	RET FUEL UNIT	1	
3780A		3780A-LHG7-E00	FUEL UNIT ASSY	FUEL UNIT ASSY	1	
50179		50179-LHG7-E00	SATY,FLOOR PANEL	SATY,FLOOR PANEL	1	
90651		90651-LGE5-E00	CLIP FUEL TANK	CLIP FUEL TANK	1	
94050		94050-06060	NUT FLANGE 6MM	NUT FLANGE 6MM	10	
95002		95002-02130	CLIP B12.5 TUBE	CLIP B 12.5 TUBE	2	
95701		95701-LDF2-800	BOLT FLANGE 5*6.5	BOLT FLANGE M5*6.5	6	

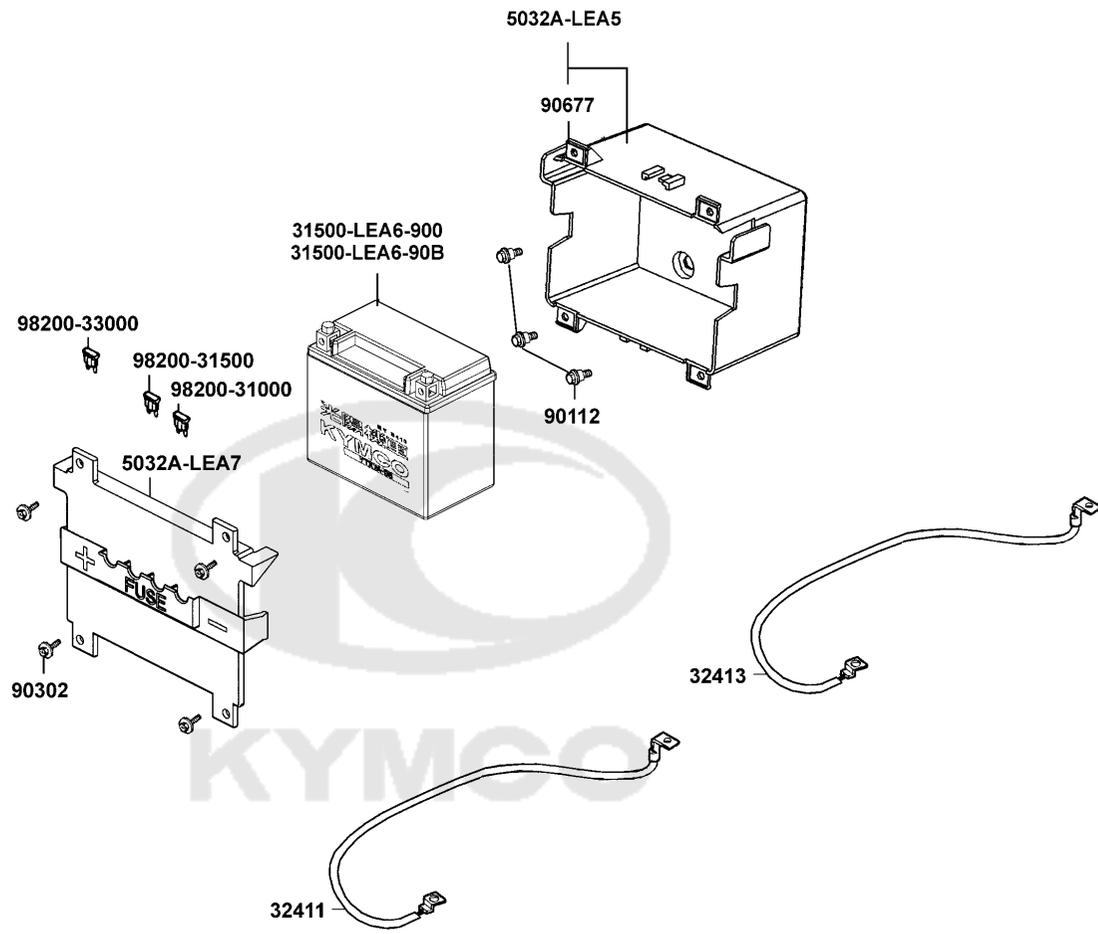

Sales mark	Ref no	Part no	Description	Reg description	Regd no	F11
	31500-LEA6-900	31500-LEA6-900	BATTERY YT12A-BS	BATTERY YT12A-BS	1	
	31500-LEA6-90B	31500-LEA6-90B	BATTERY 12A-BS	BATTERY GT12A-BS	1	
	32411	32411-LHG7-E00	CABLE, BATTERY	CABLE, BATTERY	1	
	32413	32413-LHG7-E00	CABLE, BAT. EARTH	CABLE, BAT. EARTH	1	
	5032A-LEA5	5032A-LEA5-E00	CASE ASSY BATTERY	CASE ASSY BATTERY	1	
	5032A-LEA7	5032A-LEA7-E00	COVER ASSY BATTERY	COVER ASSY BATTERY	1	
	90112	90112-KNBN-901	BOLT FLANGE 6MM	BOLT FLANGE 6MM	3	
	90302	90302-GFY6-940	BOLT-WASH 5*16	BOLT- WASH 5*16	4	
	90677	90677-GAR1-004	NUT CLIP 5MM	NUT CLIP 5MM	4	
	98200-31000	98200-31000	BLADE FUSE 10A	BLADE FUSE 10A	1	
	98200-31500	98200-31500	BLADE FUSE 15A	BLADE FUSE 15A	1	
	98200-33000	98200-33000	BLADE FUSE 30A	BLADE FUSE 30A	1	

Body CoverLuggage Box

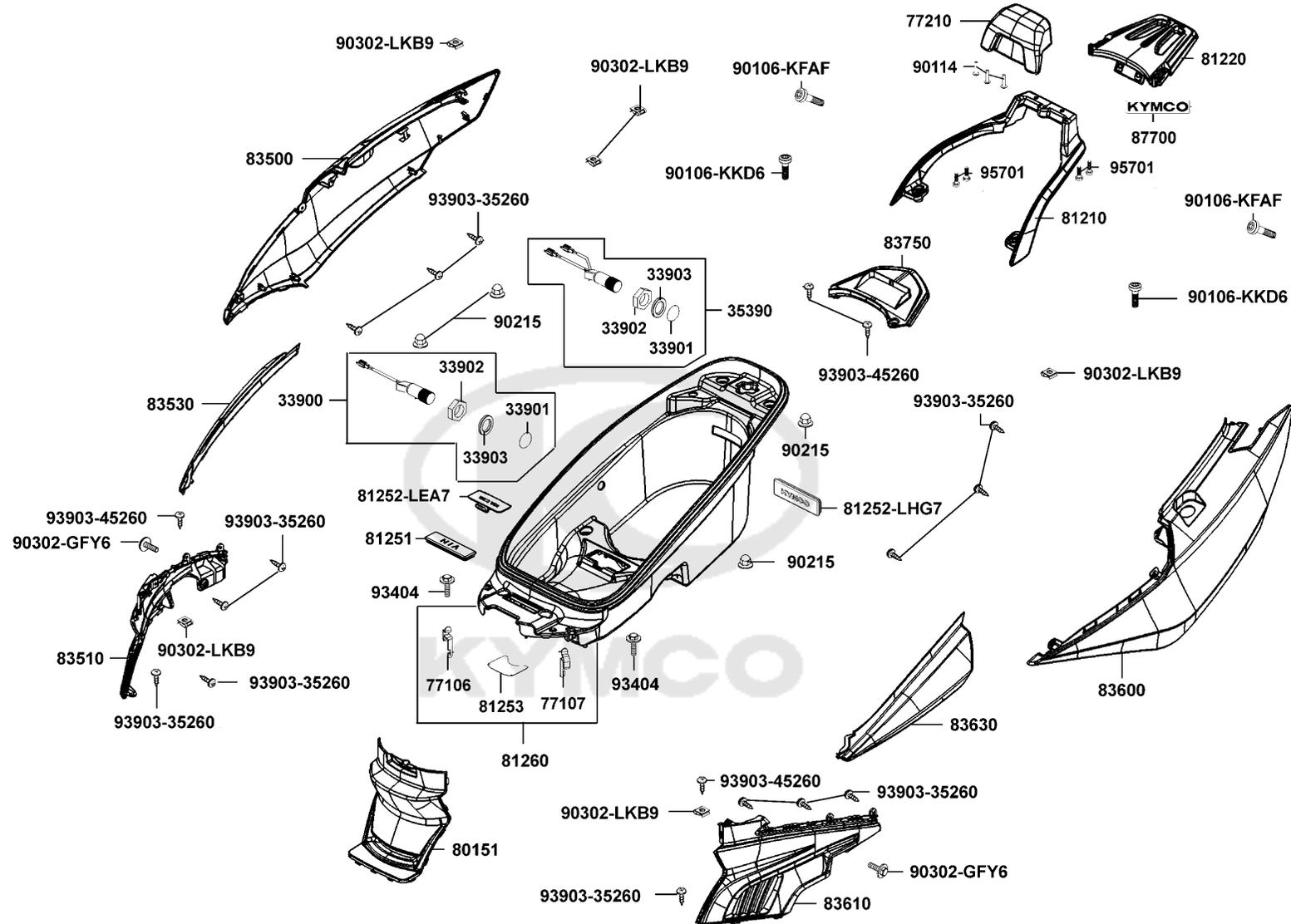

Sales mark	Ref no	Part no	Description	Reg description	Regd no	F12
	33900	33900-LHG7-E00	LIGHT ASSY LUGGAGE BOX	LIGHT ASSY LUGGAGE BOX	1	
	33901	33901-LHG7-E00	LENS	LENS	2	
	33902	33902-LHG7-E00	NUT SCREW	NUT SCREW	2	
	33903	33903-LHG7-E00	PACKING BASE	PACKING BASE	2	
	35390	35390-LHG7-E00	SENSOR ,,LUGGAGE BOX LIGHT	SENSOR ,,LUGGAGE BOX LIGHT	1	
	77106	77106-KKE5-E00	HOOK R HELMENT	HOOK R HELMENT	1	
	77107	77107-KKE5-E00	HOOK L HELMENT	HOOK L HELMENT	1	
**	77210	77210-LHG7-E00	BACK SEAT,COMP.	BACK SEAT,COMP.	1	
**	80151	80151-LHG7-E00	COVER, CENTER	COVER, CENTER	1	
**	81210	81210-LHG7-E00	REAR CARRIER,FR.	REAR CARRIER,FR.	1	
**	81220	81220-LHG7-E00	REAR CARRIER,RR.	REAR CARRIER,RR.	1	
	81251	81251-LHG7-E00	PLUG,LUGGAGE BOX	PLUG,LUGGAGE BOX	1	
	81252-LEA7	81252-LEA7-E00	COVER P.D.A. MAINT	COVER P.D.A. MAINT	1	
	81252-LHG7	81252-LHG7-E00	MAINT.LUGGAGE BOX	MAINT.LUGGAGE BOX	1	
	81253	81253-LHG7-E00	HEAT GUARD A ,LUGG. BOX	HEAT GUARD A ,LUGG. BOX	1	
	81260	81260-LHG7-E00	LUGGAGE BOX,ASSY.	LUGGAGE BOX,ASSY.	1	
**	83500	83500-LHG7-E00	COVER R,BODY	COVER R,BODY	1	
**	83510	83510-LHG7-E00	COVER ,SIDE R/H	COVER ,SIDE R/H	1	
**	83530	83530-LHG7-E00	TOP COVER R,BODY	TOP COVER R,BODY	1	
**	83600	83600-LHG7-E00	COVER L ,BODY	COVER L ,BODY	1	

Body CoverLuggage Box

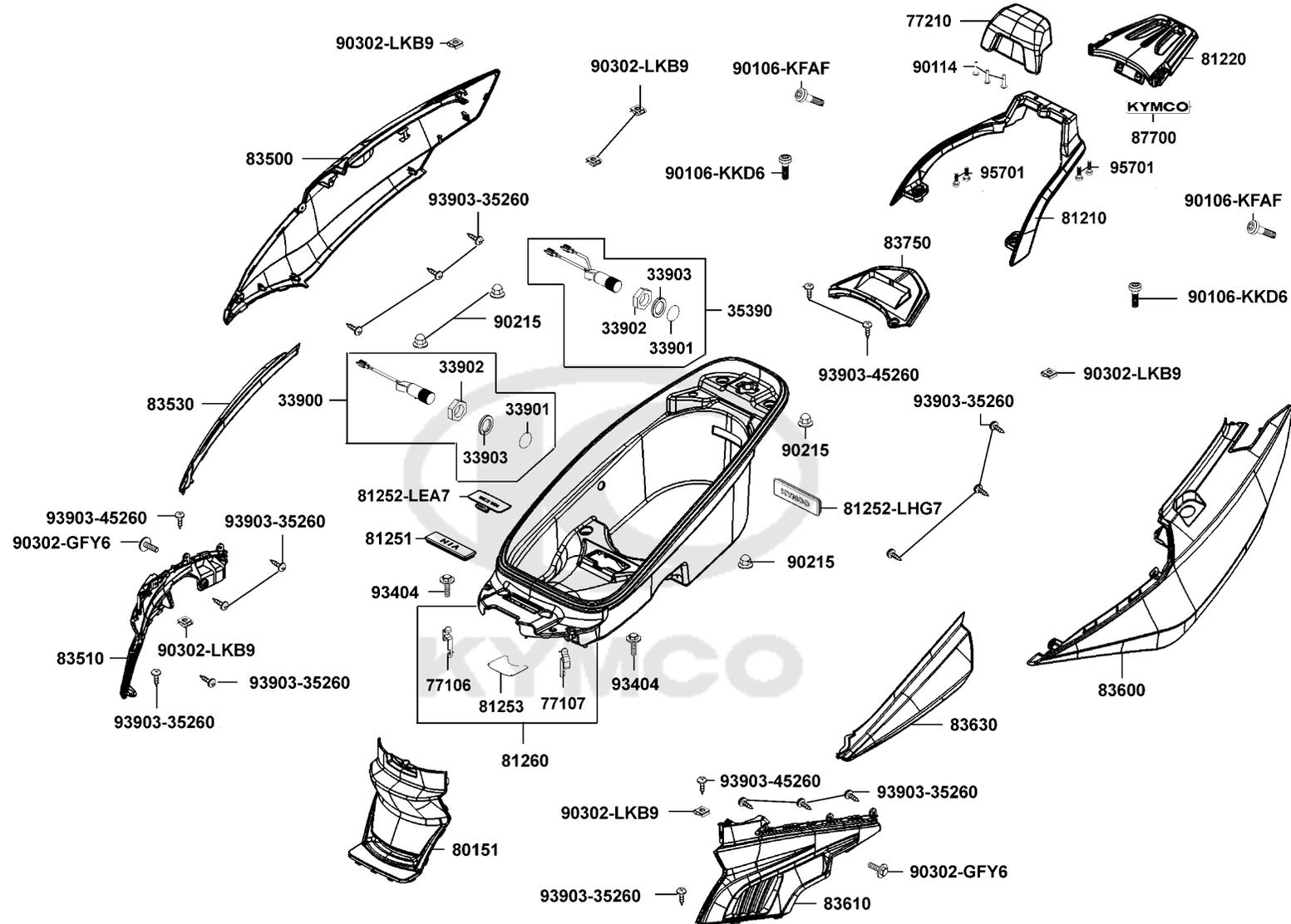

Sales mark	Ref no	Part no	Description	Reg description	Regd no	F12
**	83610	83610-LHG7-E00	COVER ,SIDE L/H	COVER ,SIDE L/H	1	
**	83630	83630-LHG7-E00	TOP COVER L,BODY	TOP COVER L,BODY	1	
**	83750	83750-LHG7-E00	COVER,RR.CENTER	COVER,RR.CENTER	1	
**	87700	87700-LBD5-E40	MARK KYMCO	MARK KYMCO	1	
	90106-KFAF	90106-KFAF-900	BOLT SPECIAL	BOLT SPECIAL 8MM	2	
	90106-KKD6	90106-KKD6-E00	BOLT SPECIAL 8*42	BOLT SPECIAL 8*42	2	
	90114	90114-LBA2-E00	SCREW PAN 6*30	SCREW PAN 6*30	3	
	90215	90215-KKC4-900	NUT CAP 6MM	NUT CAP 6MM	4	
	90302-GFY6	90302-GFY6-940	BOLT-WASH 5*16	BOLT- WASH 5*16	2	
	90302-LKB9	90302-LKB9-900	NUT SPRING 5MM	NUT SPRING 5MM	6	
	93404	93404-06016-06	BOLT WASHER 6*16	BOLT WASHER 6*16	2	
	93903-35260	93903-35260	SCREW TAPPING 5*12	SCREW TAPPING 5*12	14	
	93903-45260	93903-45260	SCREW TAPPING 5*12	SCREW TAPPING 5*12	4	
	95701	95701-08016-06	BOLT FLANGE 8*16	BOLT FLANGE 8*16	4	

F13

Air Cleaner

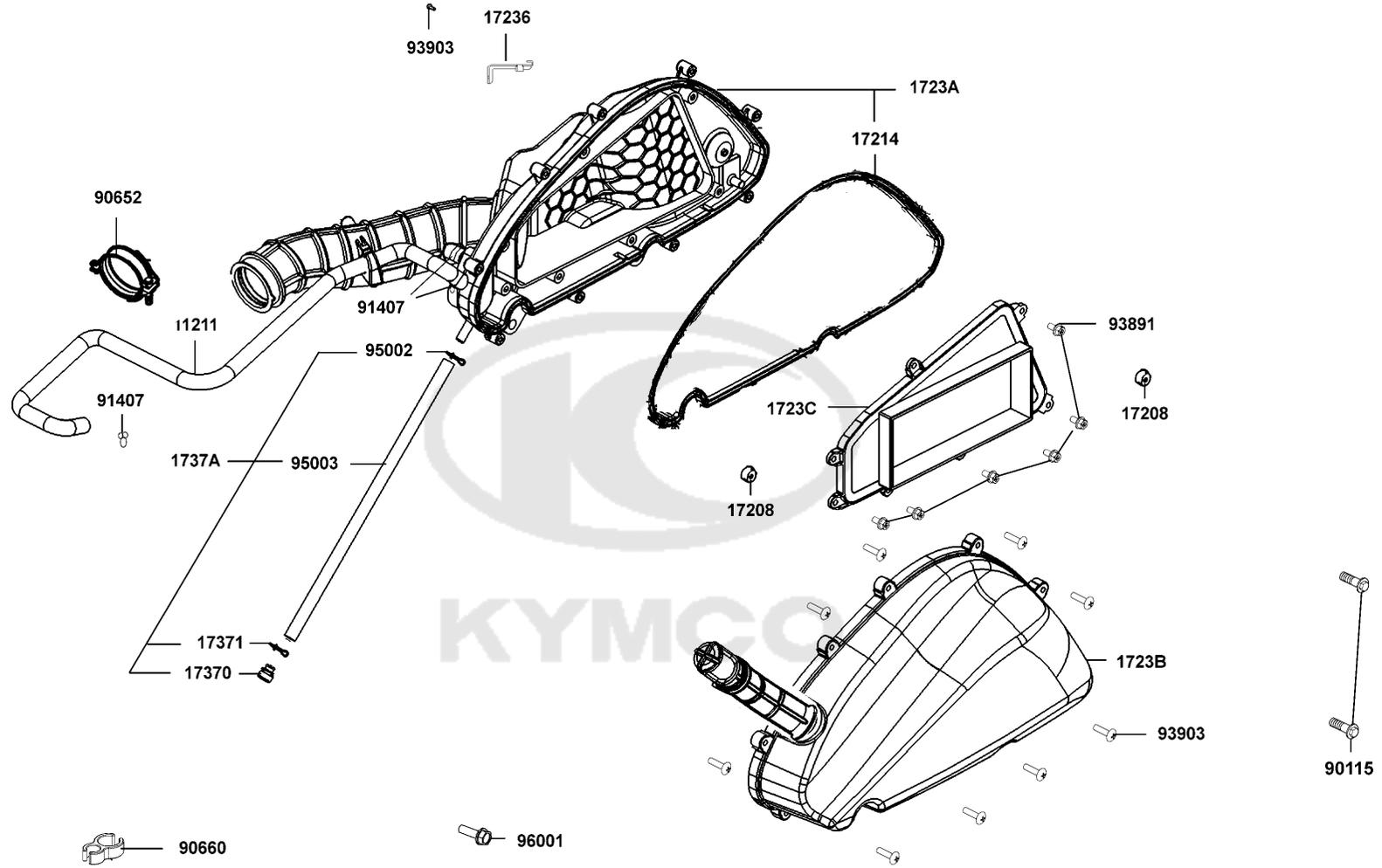



Sales mark	Ref no	Part no	Description	Reg description	Regd no	F13
	11211	11211-LHG7-E00	TUBE HEATHER	TUBE HEATHER	1	
	17208	17208-GAR1-011	COLLAR AIR/C SET	COLLAR AIR/C SET	2	
	17214	17214-LLJ3-E00	SEAL AIR/C COVER	SEAL AIR/C COVER	1	
	17236	17236-LHG7-E00	STAY, RR. FENDER	STAY, RR. FENDER	1	
	1723A	1723A-LHG7-E00	CASE ASSY AIR/C	CASE ASSY.. AIR/C	1	
	1723B	1723B-LHG7-E00	COVER ASSY AIR/C	COVER ASSY AIR/C	1	
	1723C	1723C-LHG7-E00	ELEMENT ASSY AIR/C	ELEMENT ASSY AIR/C	1	
	17370	17370-4K19-670	PLUG BREATHER TUBE	PLUG BREATHER TUBE	1	
	17371	17371-1D74-671	CLIP BREATHER TUBE	CLIP BREATHER TUBE	1	
	1737A	1737A-LHG7-E00	V TUBE ASSY.	V TUBE ASSY.	1	
	90115	90115-KXCX-900	BOLT FLANGE SH 6*32	BOLT FLANGE SH 6*32	2	
	90652	90652-KHE7-900	BAND CONNECTING TUBE	BAND CONNECTING TUBE	1	
	90660	90660-KNBN-921	CLAMP TUBE	CLAMP TUBE	1	
	91407	91407-SGA7-004	CLAMP 17 FUSE HOSE	CLAMP 17 FUSE HOSE	3	
	93891	93891-05016-00	SCREW WASHER 5*16	SCREW WASHER 5*16	6	
	93903	93903-25460	SCREW TAPPING 5*20	SCREW TAPPING 5*20	9	
	95002	95002-41100-04	CLIP D11 TUBE	CLIP D11 TUBE	1	
	95003	95003-23036-60	V TUBE 8*12*360	V TUBE 8*12*360	1	
	96001	96001-06020-08	BOLT FLANGE SH 6*20	BOLT FLANGE SH 6*20	1	

F14

Exhaust Muffler

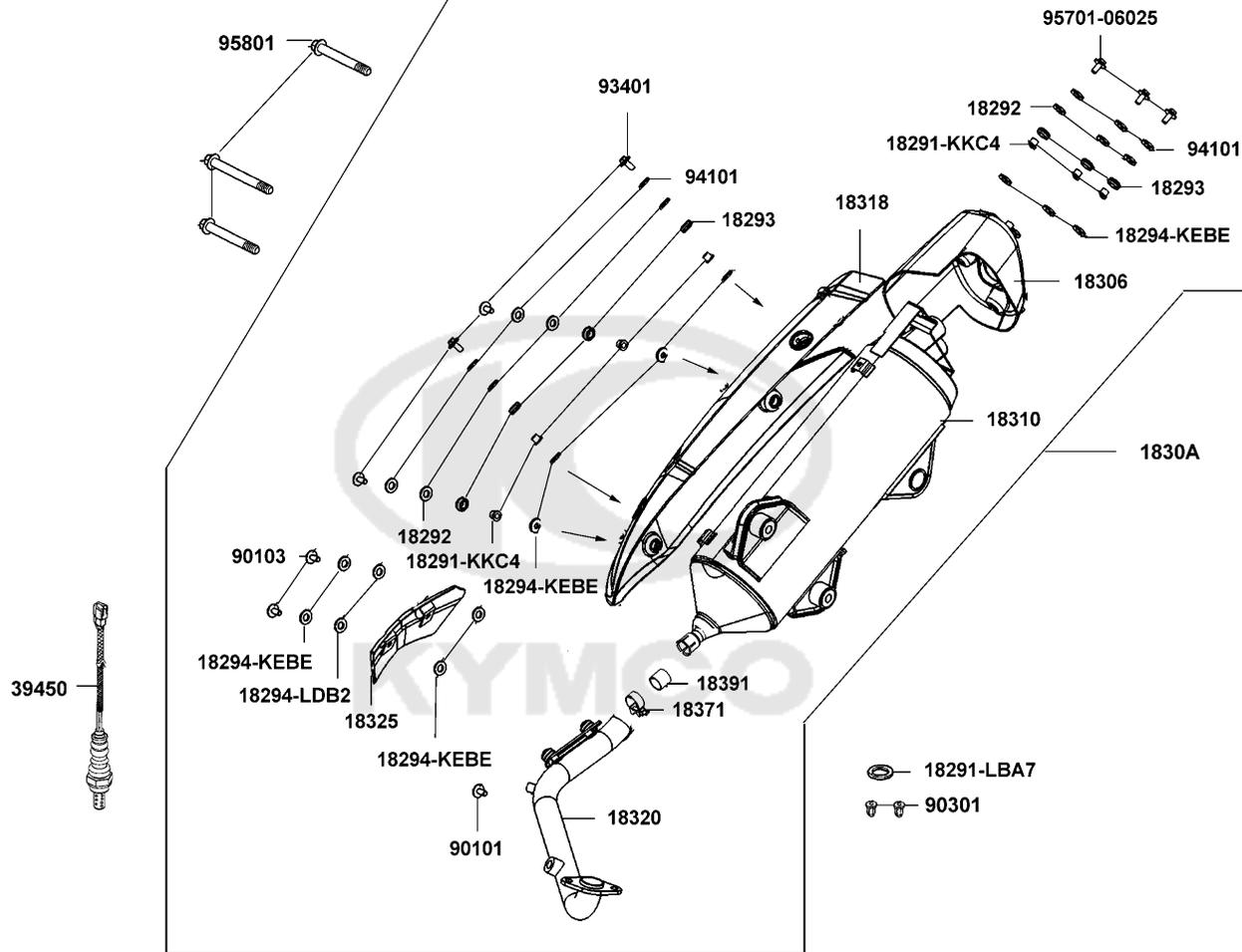

Sales mark	Ref no	Part no	Description	Reg description	Regd no	F14
	18291-KKC4	18291-KKC4-900	COLLAR	COLLAR	7	
	18291-LBA7	18291-LBA7-900	GASKET EXH PIPE	GASKET EXH PIPE	1	
	18292	18292-KEBE-900	PACKING PROTECTOR	PACKING PROTECTOR	7	
	18293	18293-KEBE-900	RUBBER PKG PROTR	RUBBER A PROTR	7	
	18294-KEBE	18294-KEBE-900	PACKING PROTECTOR	PACKING PROTECTOR	11	
	18294-LDB2	18294-LDB2-900	PACKING INNER PROTECTOR	PACKING INNER PROTECTOR	2	
**	18306	18306-LHG7-E00	TAIL CAP MUFFLER	TAIL CAP MUFFLER	1	
	1830A	1830A-LHG7-E00	MUFFLER ASSY	MUFFLER ASSY	1	
	18310	18310-LHG7-E00	MUFFLER COMP	MUFFLER COMP	1	
**	18318	18318-LHG7-E00	PROECTOR MUFFLER	PROECTOR MUFFLER	1	
	18320	18320-LHG7-E00	PIPE EXHAUST	PIPE EXHAUST	1	
**	18325	18325-LGE5-E00	PROTECTOR EXHAUST	PROTECTOR EXHAUST	1	
	18371	18371-LDB2-E00	BAND MUFFLER	BAND MUFFLER	1	
	18391	18391-LDH1-E00	GASKET COMP EXH	GASKET COMP EXH	1	
	39450	39450-LDF2-800	O2 SENSOR	O2 SENSOR	1	
	90101	90101-LEA7-E00	BOLT FLANGE SH 6X8	BOLT FLANGE SH 6X8	1	
	90103	90103-LEA7-E00	BOLT FLANGE SH 6X16	BOLT FLANGE SH 6X16	2	
	90301	90301-GFY6-901	NUT (HEX) CAP 8MM	NUT (HEX) CAP 8MM	2	
	93401	93401-06022-07	BOLT WASHER 6*22	BOLT WASHER 6*22	4	
	94101	94101-LEA2-900	WASHER PLAIN 6.5*18*105	WASHER PLAIN 6.5*18*105	7	

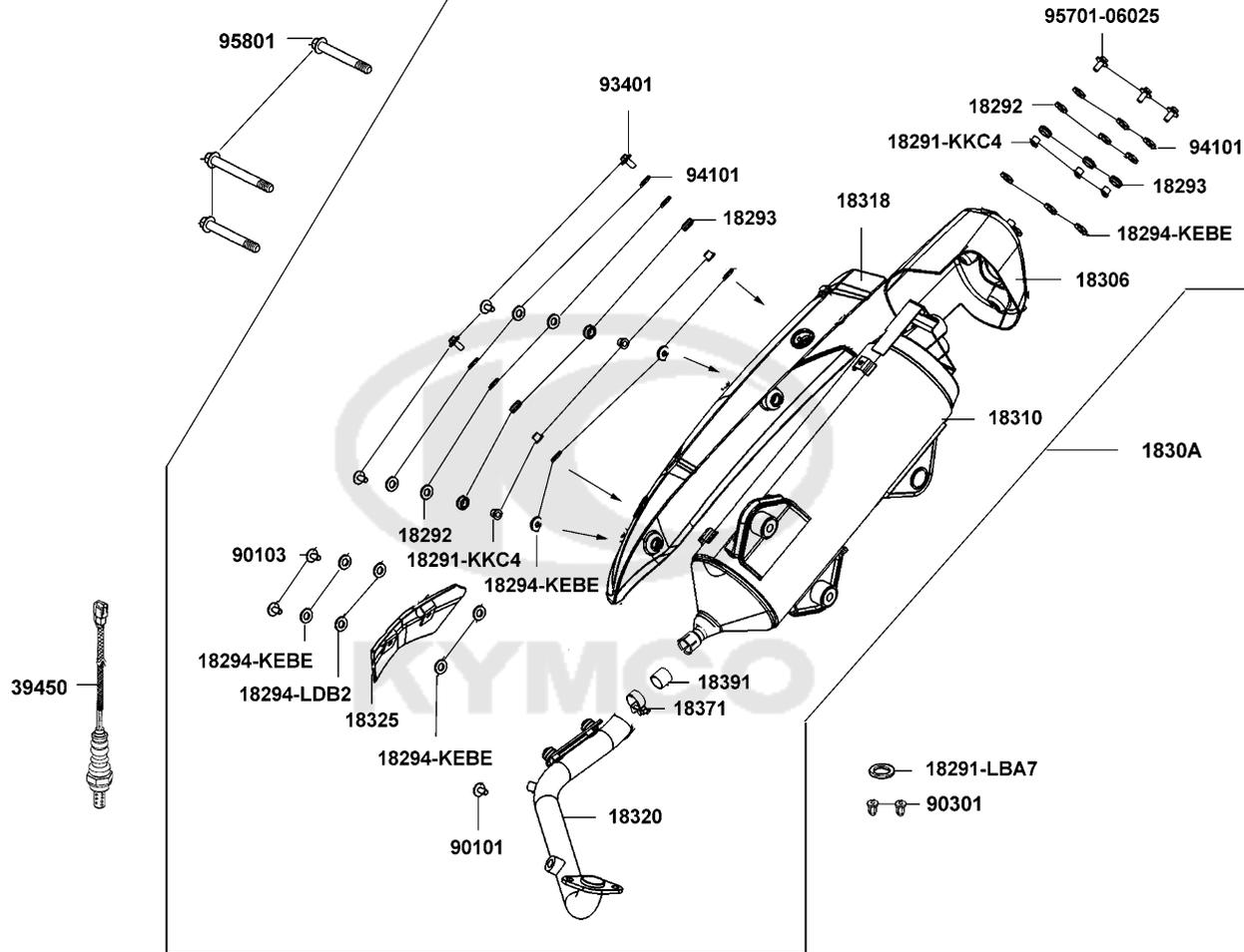

Sales mark	Ref no	Part no	Description	Reg description	Regd no	<b>F14</b>
------------	--------	---------	-------------	-----------------	---------	------------

	95701-06025	95701-06025-06	BOLT FLANGE 6*25	BOLT FLANGE 6*25	3	
	95801	95801-10060-06	BOLT FLANGE 10*60	BOLT FLANGE 10*60	3	



F15

StandKick Starter Arm

BODY FRAME

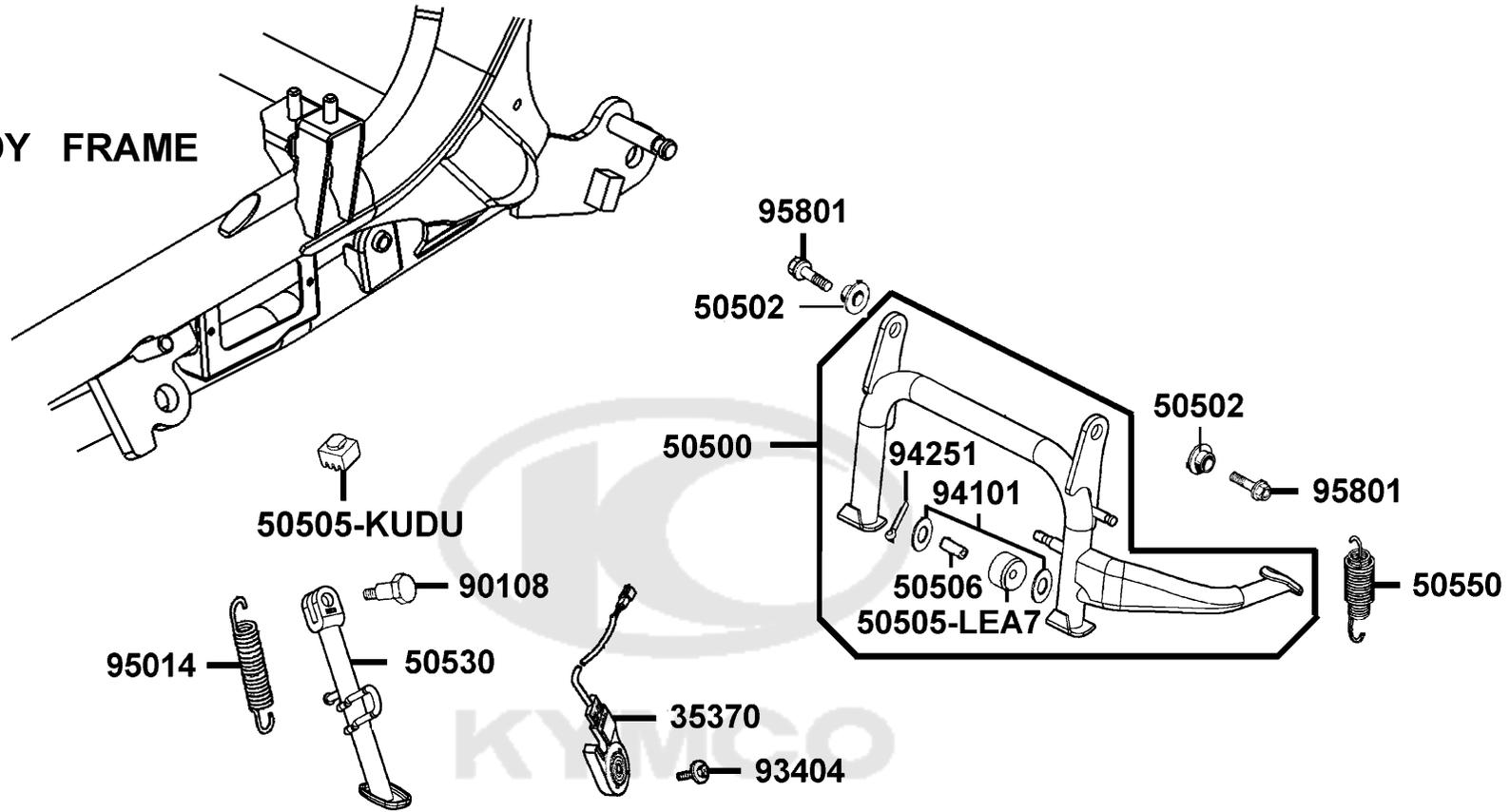

Sales mark	Ref no	Part no	Description	Reg description	Regd no	<b>F15</b>
35370		35370-LLJ3-E00	SW UNIT SIDE STAND	SW UNIT SIDE STAND	1	
50500		50500-LHG7-E00	STAND COMP MAIN	STAND COMP MAIN	1	
50502		50502-LDF7-E10	COLLAR MAIN STAND	COLLAR MAIN STAND	2	
50505-KUDU		50505-KUDU-900	STOPPER RUBBER STAND	STOPPER RUBBER STAND	1	
50505-LEA7		50505-LEA7-E00	STOPPER RUBBER	STOPPER RUBBER	1	
50506		50506-KHE7-E00	COLLAR STOPPER RUBBER	COLLAR STOPPER RUBBER	1	
50530		50530-LHG7-E00	STAND COMP.,SIDE	STAND COMP.,SIDE	1	
50550		50550-KKC2-E00	SPG ASSY MAIN STAND	SPG ASSY MAIN STAND	1	
90108		90108-KKC4-900	SCREW SIDE STAND PIVOT	SCREW SIDE STAND PIVOT	1	
93404		93404-06016-06	BOLT WASHER 6*16	BOLT WASHER 6*16	1	
94101		94101-08600	WASH PLAIN 8MM	WASH PLAIN 8MM	2	
94251		94251-08400	PIN LOCK 8MM	PIN LOCK 8MM	1	
95014		95014-72204	SPG B1 SIDE STAND	SPG B1 SIDE STAND	1	
95801		95801-10030-06	BOLT FLANGE 10*30(G)	BOLT FLANGE 10*30(G)	2	

F16

Rear Cushion

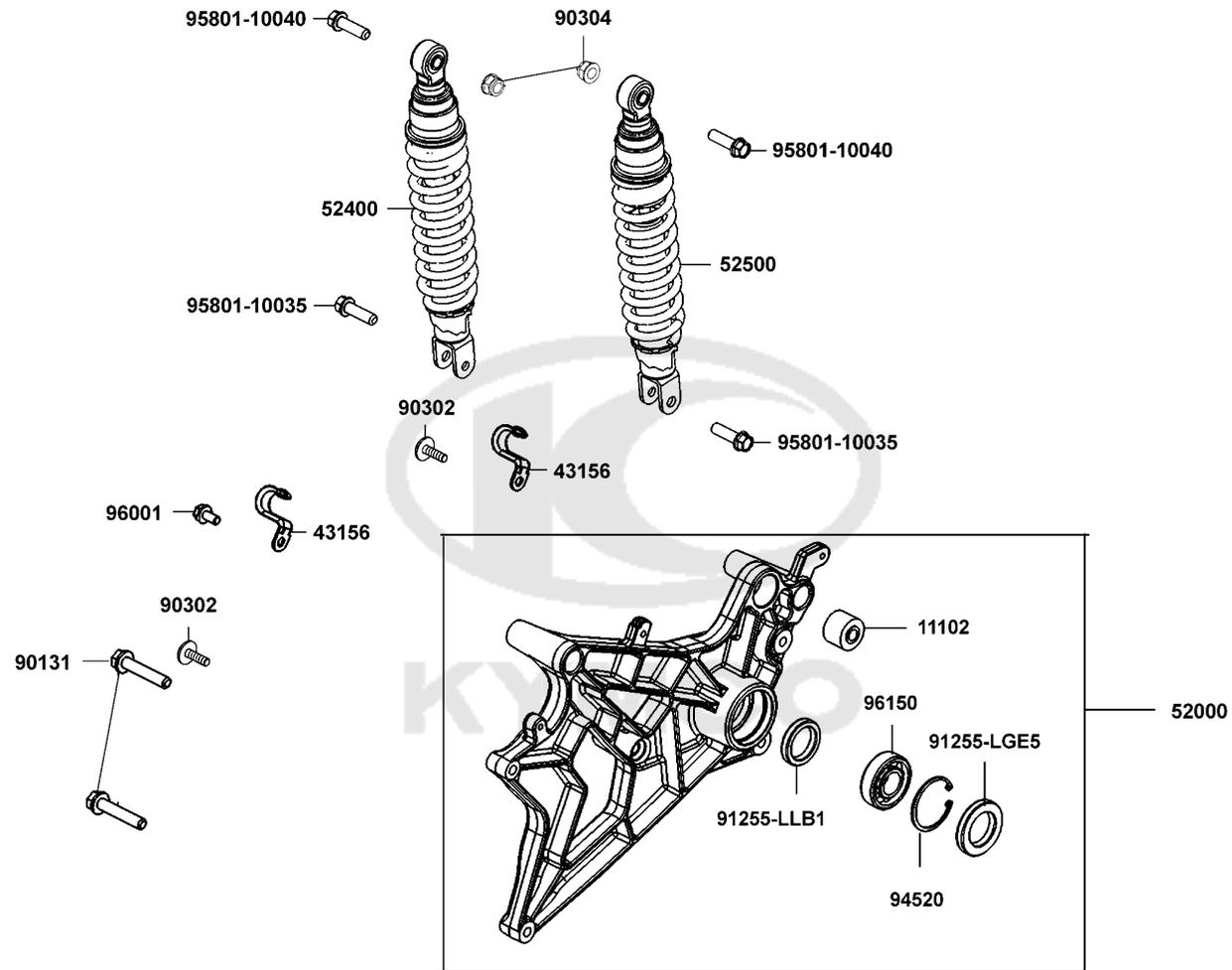



Sales mark	Ref no	Part no	Description	Reg description	Regd no	F16
	11102	11102-1G87-004	RUB BUSH ENG HANGER	RUB BUSH ENG HANGER	1	
	43156	43156-LDB2-900	CLAMPER HOSE RR	CLAMPER HOSE RR	2	
**	52000	52000-LHG7-E00	FORK ASSY RR	FORK ASSY RR	1	
**	52400	52400-LHG7-E00	CUSHION ASSY RR R	CUSHION ASSY RR R	1	
**	52500	52500-LHG7-E00	CUSHION ASSY RR L	CUSHION ASSY RR L	1	
	90131	90131-KFAF-900	BOLT FLANGE 8*42	BOLT FLANGE 8*42	2	
	90302	90302-KFC2-900	BOLT WASHER 5*25	BOLT WASH 5*25	2	
	90304	90304-GHE8-004	NUT U 10MM	NUT U 10MM	2	
	91255-LGE5	91255-LGE5-E00	OIL SEAL 30*48*7	OIL SEAL 30*48*7	1	
	91255-LLB1	91255-LLB1-900	OIL SEAL 30*40*7	OIL SEAL 30*40*7	1	
	94520	94520-47000	CIR CLIP IN 47	CIR CLIP IN 47	1	
	95801-10035	95801-10035-06	BOLT FLANGE 10*35	BOLT FLANGE 10*35	2	
	95801-10040	95801-10040-06	BOLT FLANGE 10*40 ( G)	BOLT FLANGE 10*40 ( G)	2	
	96001	96001-06012-08	BOLT FLANGE 6*12	BOLT FLANGE SH 6*12	1	
	96150	96150-62040-10	BEARING BALL RADIAL 6204	BEARING BALL RADIAL 6204	1	

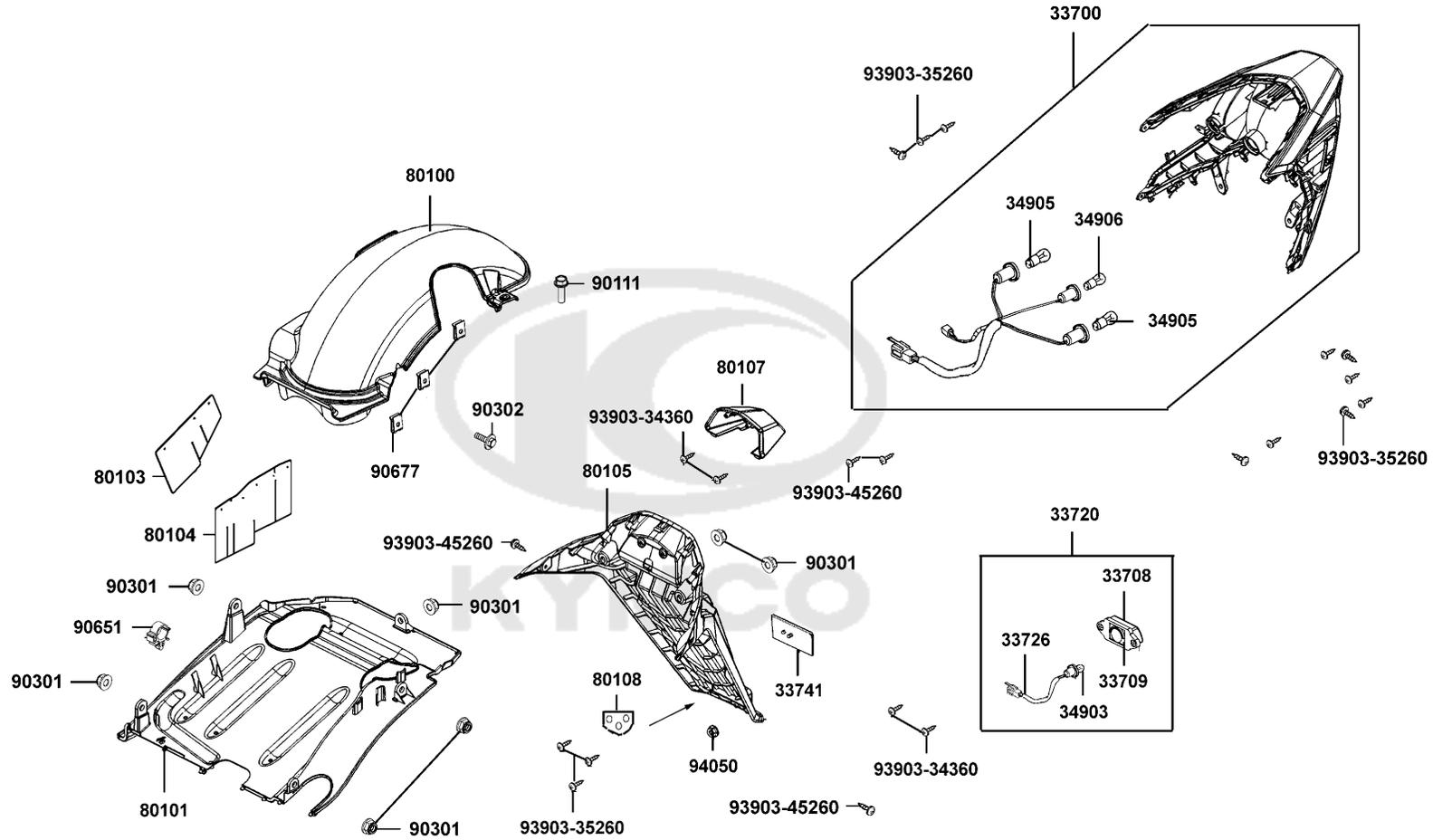

Sales mark	Ref no	Part no	Description	Reg description	Regd no	F17
	33700	33700-LHG7-E00	TAIL LIGHT ASS'Y.,RR.COM	TAIL LIGHT ASS'Y.,RR.COM	1	
	33708	33708-KHE7-E00	LENS LICENSE	LICENSE LENS	1	
	33709	33709-KHE7-E00	BASE LICENSE	BASE LICENSE	1	
	33720	33720-LBB5-E00	LIGHT ASSY LICENSE	LIGHT ASSY LICENSE	1	
	33726	33726-LBB5-E00	SCOKET COMP	SCOKET COMP	1	
	33741	33741-KHC5-M00	REFLEX REFLECTOR	REFLEX REFLECTOR	1	
	34903	34903-KPCP-900	BULB POSITION	BULB POSITION	1	
	34905	34905-LCA5-E00	BULB WINKER	BULB WINKER	2	
	34906	34906-KPCP-900	BULB TAIL & STOP 12V21W/5W	BULB TAIL & STOP 12V21W/5W	1	
**	80100	80100-LHG7-E00	FENDER RR TIRE	FENDER RR TIRE	1	
**	80101	80101-LHG7-E00	FENDER RR. INNER	FENDER RR. INNER	1	
	80103	80103-LHG7-E00	GUARD SPLASH	GUARD SPLASH	1	
	80104	80104-LHG7-E00	PLATE 0 SPLASH GUARD	PLATE 0 SPLASH GUARD	1	
**	80105	80105-LHG7-E00	FENDER REAR	FENDER REAR	1	
	80107	80107-LEA7-E00	COVER LICENSE LIGHT	COVER LICENSE LIGHT	1	
	80108	80108-LEA2-900	PLATE, RR FENDER	PLATE, RR FENDER	1	
	90111	90111-KKD7-900	BOLT FLANGE 6MM	BOLT FLANGE 6MM	1	
	90301	90301-6D34-671	NUT FLANGE 6MM	NUT FLANGE 6MM	7	
	90302	90302-KFC2-900	BOLT WASHER 5*25	BOLT WASH 5*25	1	
	90651	90651-LKE6-900	CLIP CABLE	CLIP CABLE	1	

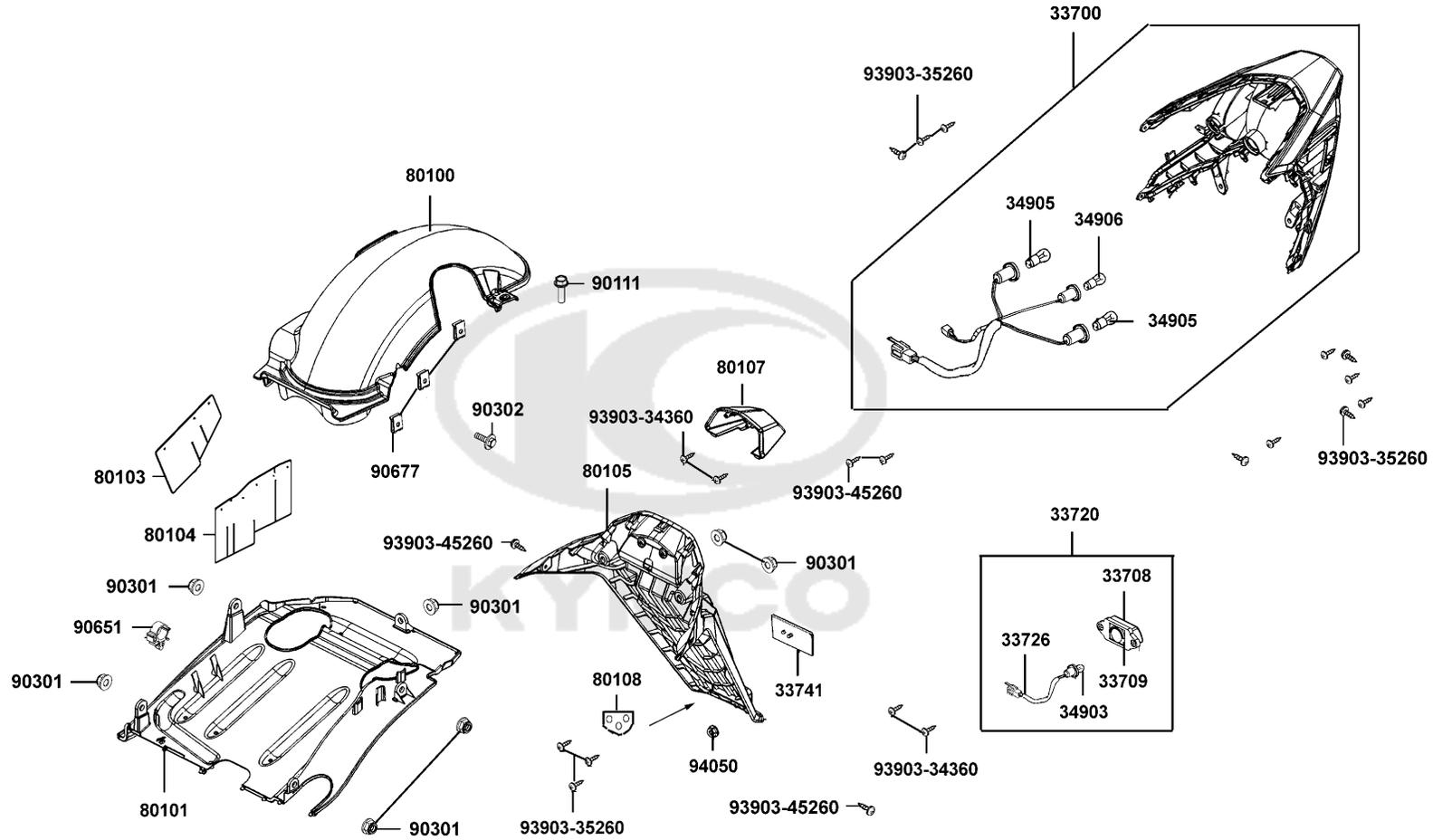

Sales mark	Ref no	Part no	Description	Reg description	Regd no	<b>F17</b>
90677		90677-GAR1-004	NUT CLIP 5MM	NUT CLIP 5MM	3	
93903-34360		93903-34360	SCREW TAPPING 4*12 (G)	SCREW TAPPING 4*12	4	
93903-35260		93903-35260	SCREW TAPPING 5*12	SCREW TAPPING 5*12	13	
93903-45260		93903-45260	SCREW TAPPING 5*12	SCREW TAPPING 5*12	4	
94050		94050-05080	NUT FLANGE 5MM	NUT FLANGE 5MM	1	



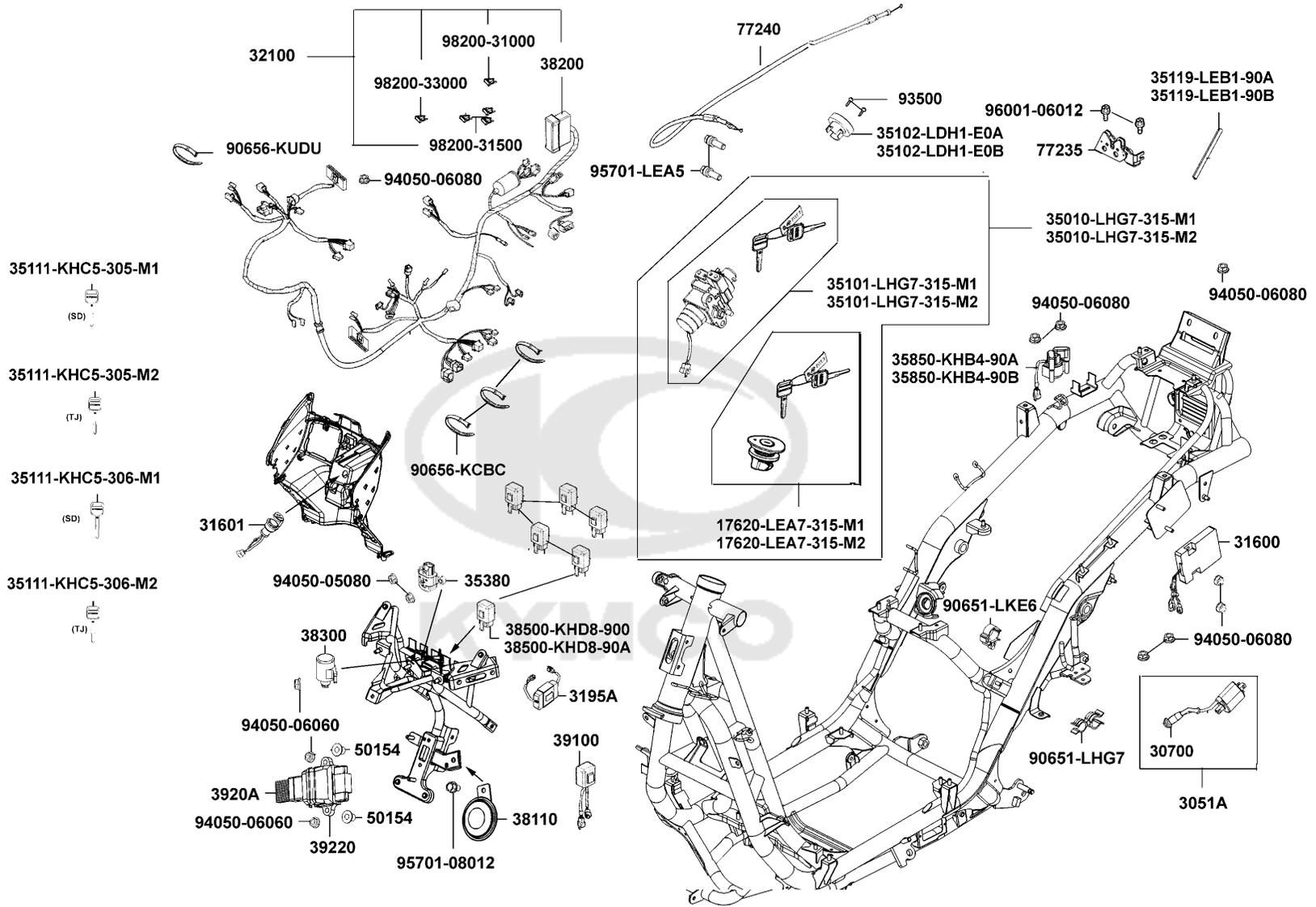

Sales mark	Ref no	Part no	Description	Reg description	Regd no	F18
	17620-LEA7-315-M1	17620-LEA7-315-M1	CAP COMP FUEL FILLER	CAP COMP FUEL FILLER	1	
	17620-LEA7-315-M2	17620-LEA7-315-M2	CAP COMP FUEL FILLER	CAP COMP FUEL FILLER	1	
	3051A	3051A-LEK1-E01	COIL ASSY IGNITION	COIL ASSY IGNITION	1	
	30700	30700-LKG2-910	CAP ASSY NOISE SUPPR	CAP ASSY NOISE SUPPR	1	
	31600	31600-LHG7-E00	REG RECT COMP	REG RECT COMP	1	
	31601	31601-LEA7-E00	SOCKET COMP DC 12V	SOCKET COMP DC 12V	1	
	3195A	3195A-LEA7-E05	HAZARD CONTROL ASSY	HAZARD CONTROL ASSY	1	
	32100	32100-LHG7-E00	HARNES WIRE	HARNES WIRE	1	
	35010-LHG7-315-M1	35010-LHG7-315-M1	KEY SET FOR SERVICE	KEY SET FOR SERVICE	1	
	35010-LHG7-315-M2	35010-LHG7-315-M2	KEY SET FOR SERVICE	KEY SET FOR SERVICE	1	
	35101-LHG7-315-M1	35101-LHG7-315-M1	SW COMB LOCK	SW COMB LOCK	1	
	35101-LHG7-315-M2	35101-LHG7-315-M2	SW COMB LOCK	SW COMB LOCK	1	
	35102-LDH1-E0A	35102-LDH1-E0A	COLLAR MAIN SW	COLLAR MAIN SW	1	
	35102-LDH1-E0B	35102-LDH1-E0B	COLLAR MAIN SW	COLLAR MAIN SW	1	
	35111-KHC5-305-M1	35111-KHC5-305-M1	KEY COMP	KEY COMP	1	
	35111-KHC5-305-M2	35111-KHC5-305-M2	KEY COMP	KEY COMP	1	
	35111-KHC5-306-M1	35111-KHC5-306-M1	KEY COMP	KEY COMP	1	
	35111-KHC5-306-M2	35111-KHC5-306-M2	KEY COMP	KEY COMP	1	
	35119-LEB1-90A	35119-LEB1-90A	COVER SEAT CABLE	COVER SEAT CABLE	1	
	35119-LEB1-90B	35119-LEB1-90B	COVER SEAT CABLE	COVER SEAT CABLE	1	

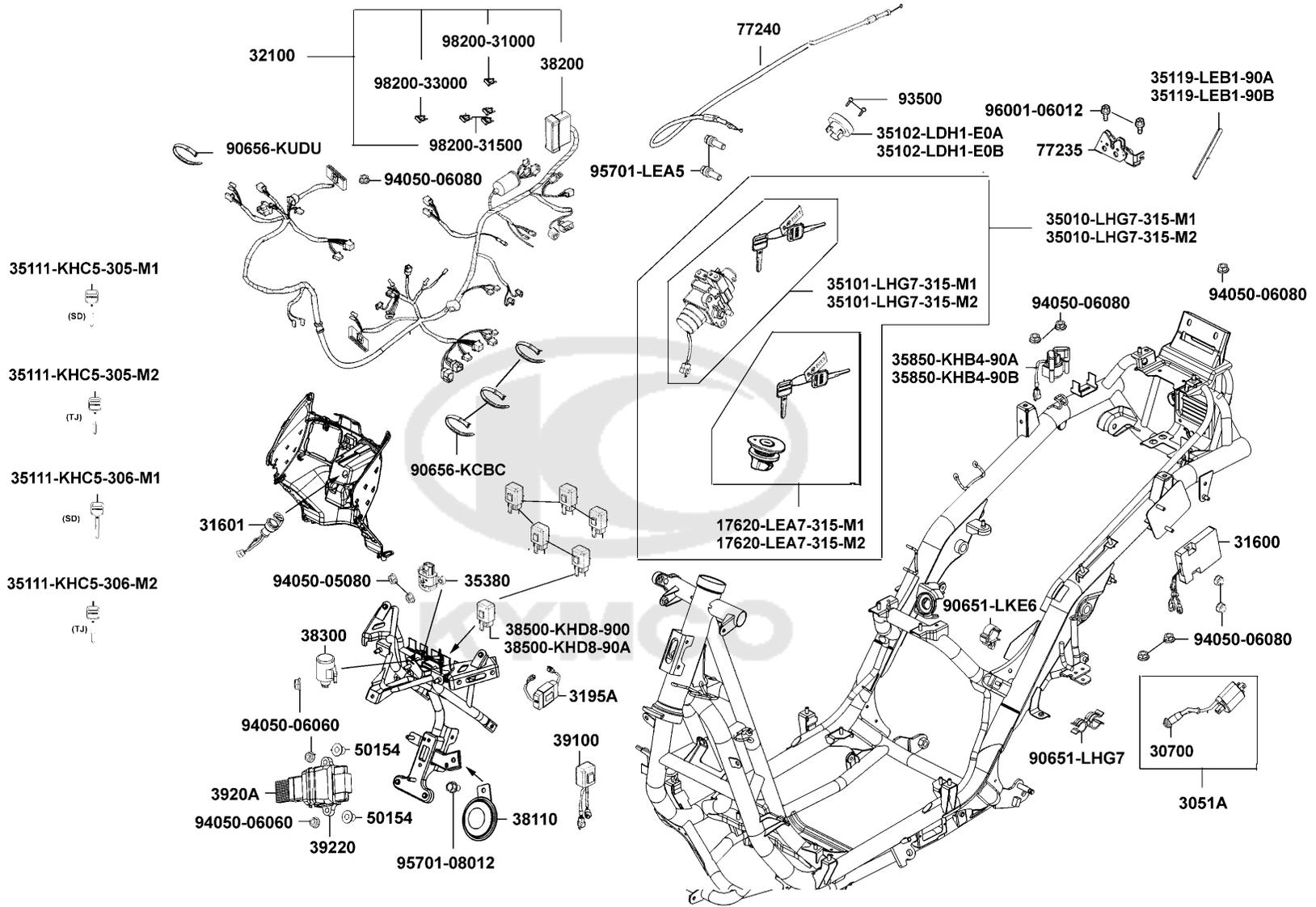



Sales mark	Ref no	Part no	Description	Reg description	Regd no	F18
	35380	35380-LKG2-900	SENSOR ANGLE DETECT	SENSOR ANGLE DETECT	1	
	35850-KHB4-90A	35850-KHB4-90A	SET START MAG	SET START MAG	1	
	35850-KHB4-90B	35850-KHB4-90B	SET START MAG	SET START MAG	1	
	38110	38110-KKC3-90B	HORN COMP	HORN COMP	1	
	38200	38200-KHE7-900	BOX COMP FUSE	BOX COMP FUSE	1	
	38300	38300-LEA7-E00	RELAY COMP.,WINKER	RELAY COMP.,WINKER	1	
	38500-KHD8-900	38500-KHD8-900	RELAY ASSY LIGHT	RELAY ASSY LIGHT	1	
	38500-KHD8-90A	38500-KHD8-90A	RELAY ASSY LIGHT	RELAY ASSY LIGHT	1	
	39100	39100-KKE5-E01	EMI FILTER MOTOR	EMI FILTER MOTOR	1	
	3920A	3920A-LHG7-E00	ASSY ECU	ASSY. ECU	1	
	39220	39220-LKG2-900	CUSHION ECU	CUSHION ECU	1	
	50154	50154-KKE3-900	COLLAR ECU	COLLAR ECU	2	
	77235	77235-LEA1-900	CATCH COMP SEAT	CATCH COMP SEAT	1	
	77240	77240-LHG7-E00	CABLE, SEAT LOCK	CABLE, SEAT LOCK	1	
	90651-LHG7	90651-LHG7-E00	STOPPER RING	STOPPER RING	1	
	90651-LKE6	90651-LKE6-900	CLIP CABLE	CLIP CABLE	1	
	90656-KCBC	90656-KCBC-900	BAND OIL HOSE	BAND OIL HOSE	3	
**	90656-KUDU	90656-KUDU-900	BAND HARNESS WIRE	BAND HARNESS WIRE	4	
	93500	93500-KHC4-90A	SCREW PAN 5*10	SCREW PAN 5*10	2	
	94050-05080	94050-05080	NUT FLANGE 5MM	NUT FLANGE 5MM	2	

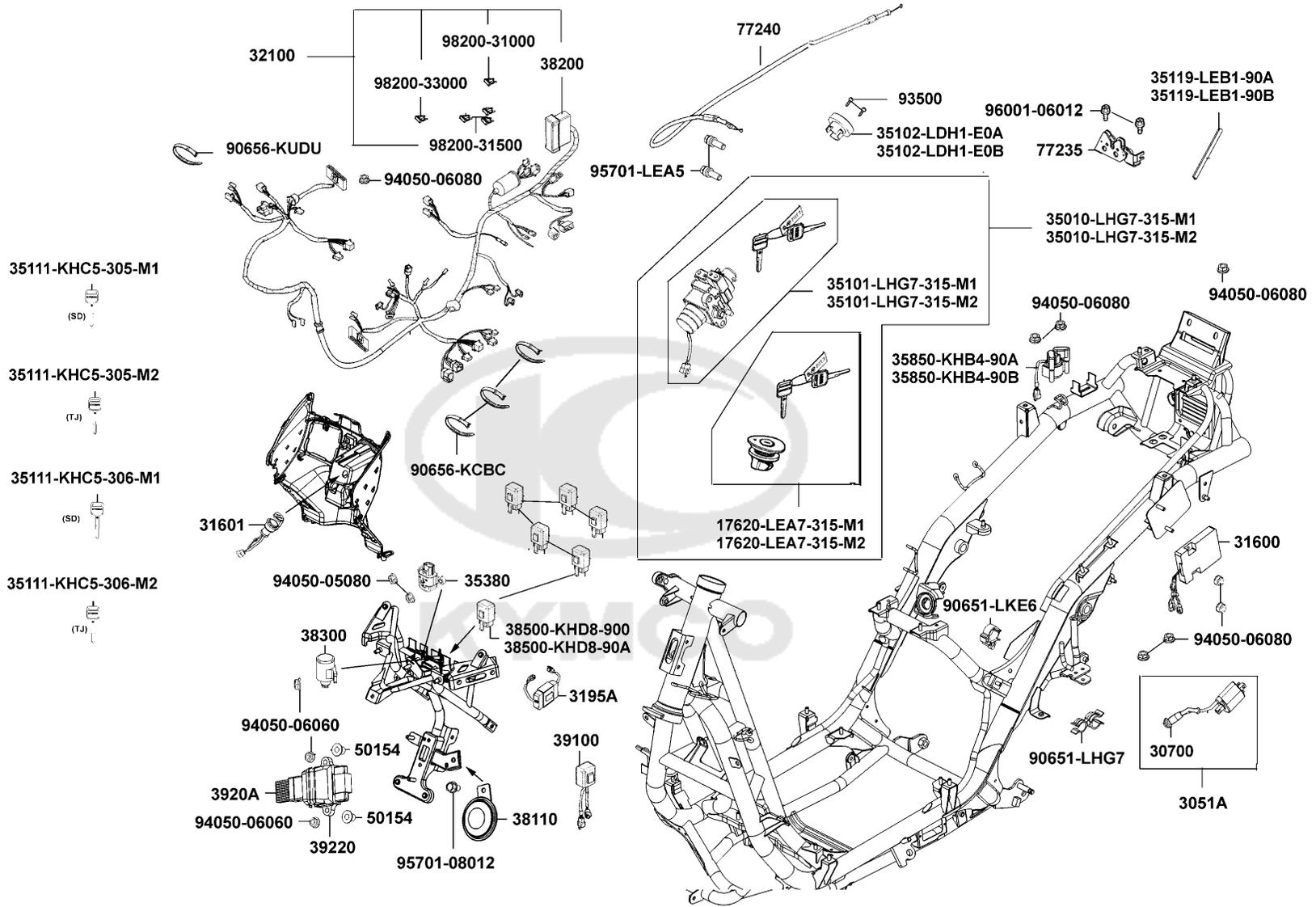

Sales mark	Ref no	Part no	Description	Reg description	Regd no	<b>F18</b>
	94050-06060	94050-06060	NUT FLANGE 6MM	NUT FLANGE 6MM	3	
	94050-06080	94050-06080	NUT FLANGE 6MM	NUT FLANGE 6MM	8	
	95701-08012	95701-08012-06	BOLT FLANGE 8*12	BOLT FLANGE 8*12	1	
	95701-LEA5	95701-LEA5-E00	BOLT TORQUE 8*25	BOLT TORQUE 8*25	2	
	96001-06012	96001-06012-08	BOLT FLANGE 6*12	BOLT FLANGE SH 6*12	2	
	98200-31000	98200-31000	BLADE FUSE 10A	BLADE FUSE 10A	1	
	98200-31500	98200-31500	BLADE FUSE 15A	BLADE FUSE 15A	3	
	98200-33000	98200-33000	BLADE FUSE 30A	BLADE FUSE 30A	1	

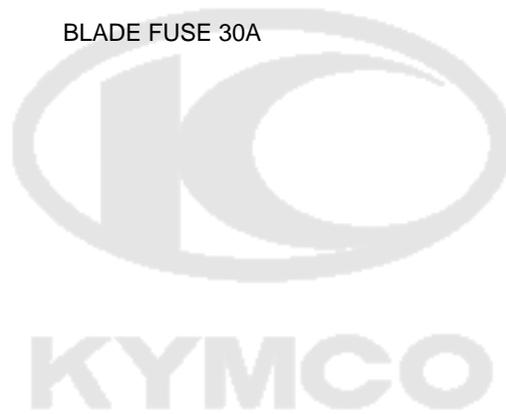

F19

Frame Body

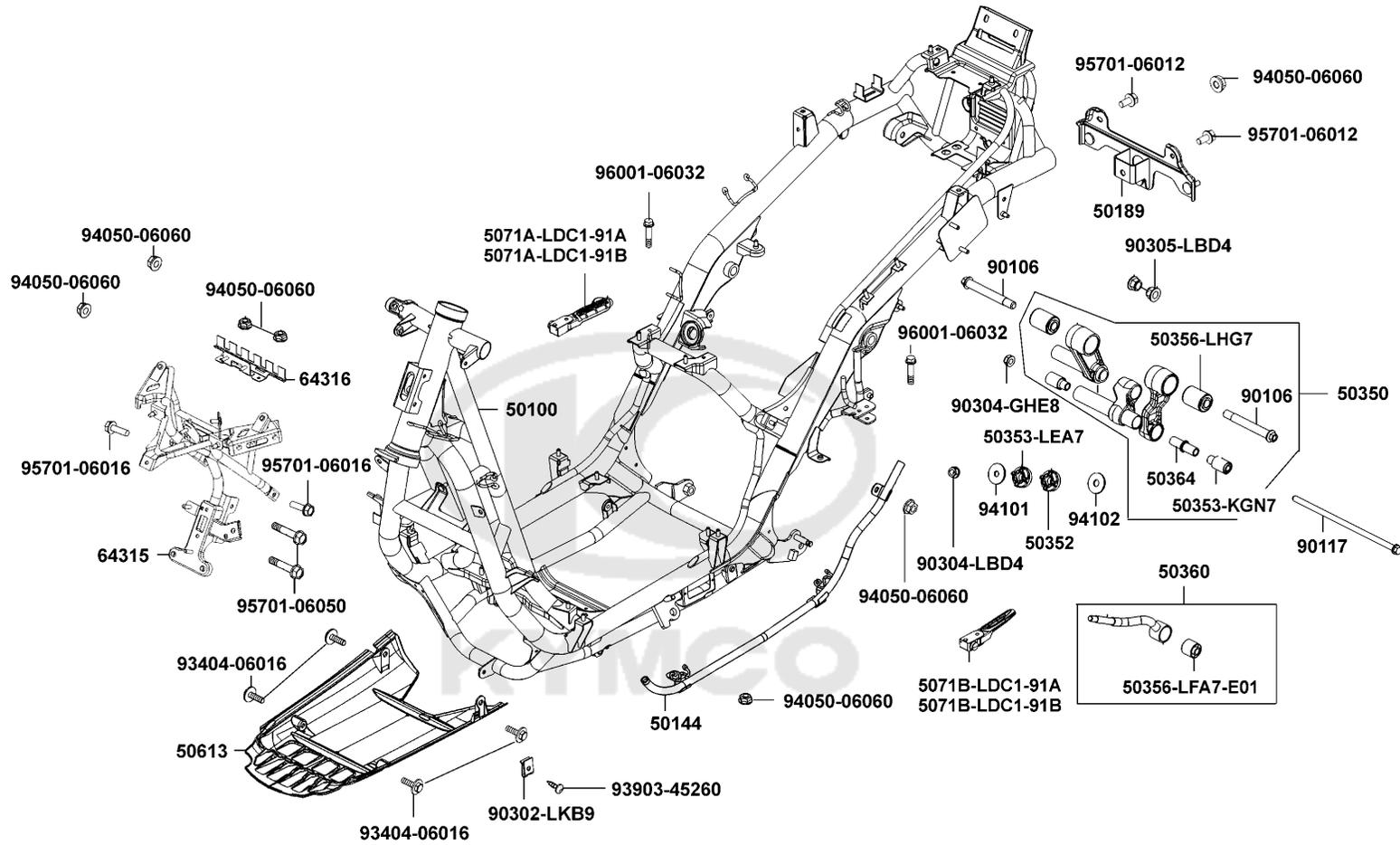

Sales mark	Ref no	Part no	Description	Reg description	Regd no	F19
	50100	50100-LHG7-E00	BODY COMP FRAME	BODY COMP FRAME	1	
	50144	50144-LHG7-E00	PROTECTOR PIPE FR.,SEAT WIRE	PROTECTOR PIPE FR.,SEAT WIRE	1	
	50189	50189-LHG7-E00	STAY,TAIL LIGHT	STAY,TAIL LIGHT	1	
	50350	50350-LHG7-E00	HANGER ASSY ENG	HANGER ASSY ENG	1	
	50352	50352-LBA2-E00	RUBBER STOPPER	RUBBER STOPPER	1	
	50353-KGN7	50353-KGN7-901	BUSH A ENG HANGER	BUSH A ENG HANGER	1	
	50353-LEA7	50353-LEA7-E00	RUBBER STOPPER	RUBBER STOPPER	2	
	50356-LFA7-E01	50356-LFA7-E01	RUB BUSH TIE ROD	RUB BUSH TIE ROD	1	
	50356-LHG7	50356-LHG7-E00	RUBBER BUSH ENG HANGER	RUBBER BUSH ENG HANGER	2	
	50360	50360-LHG7-E00	TIE-ROD ASSY ENG	TIE-ROD ASSY ENG	1	
	50364	50364-KHE7-E00	COLLAR B ENG HANGER	COLLAR ENG HANGER	1	
**	50613	50613-LHG7-E00	COVER, UNDER	COVER, UNDER	1	
	5071A-LDC1-91A	5071A-LDC1-91A	BAR STEP R ASSY	BAR STEP R ASSY	1	
	5071A-LDC1-91B	5071A-LDC1-91B	BAR STEP R ASSY	BAR STEP R ASSY	1	
	5071B-LDC1-91A	5071B-LDC1-91A	BAR STEP L ASSY	BAR STEP L ASSY	1	
	5071B-LDC1-91B	5071B-LDC1-91B	BAR STEP L ASSY	BAR STEP L ASSY	1	
	64315	64315-LHG7-E00	BRKT. ,FR COVER	BRKT. ,FR COVER	1	
	64316	64316-LHG7-E00	STAY,ANGLE DETECT SENSOR	STAY,ANGLE DETECT SENSOR	1	
	90106	90106-LEA7-E00	BOLT FLANGE 15x118(M14)	BOLT FLANGE 15x118(M14)	2	
	90117	90117-KED9-900	BOLT FLANGE 10*265	BOLT FLANGE 10*265	1	

F19

Frame Body

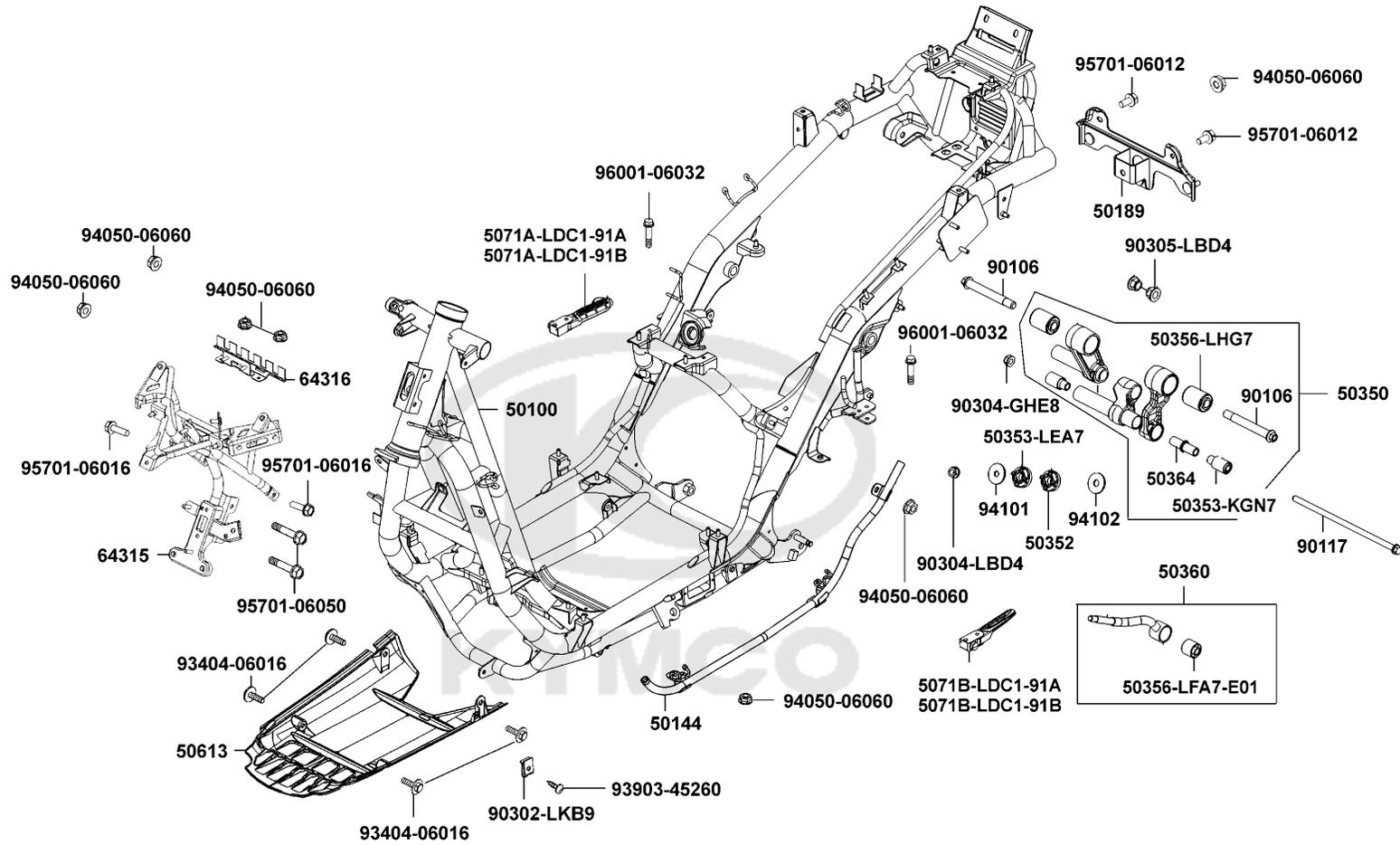

Sales mark	Ref no	Part no	Description	Reg description	Regd no	<b>F19</b>
	90302-LKB9	90302-LKB9-900	NUT SPRING 5MM	NUT SPRING 5MM	1	
	90304-GHE8	90304-GHE8-004	NUT U 10MM	NUT U 10MM	1	
	90304-LBD4	90304-LBD4-900	NUT U FLANGE 10MM	NUT U FLANGE 10MM	1	
	90305-LBD4	90305-LBD4-900	NUT U 14MM	NUT U 14MM	2	
	93404-06016	93404-06016-06	BOLT WASHER 6*16	BOLT WASHER 6*16	4	
	93903-45260	93903-45260	SCREW TAPPING 5*12	SCREW TAPPING 5*12	1	
	94050-06060	94050-06060	NUT FLANGE 6MM	NUT FLANGE 6MM	7	
	94101	94101-LBA2-E00	WASHER PLATE 10.5*38*3.0	WASHER PLATE 10.5*38*3.0	1	
	94102	94102-LBA2-E00	WASHER PLAIN 38*12.5*3	WASHER PLAIN 38*12.5*3	1	
	95701-06012	95701-06012-06	BOLT FLANGE 6*12	BOLT FLANGE 6*12	2	
	95701-06016	95701-06016-06	BOLT FLANGE 6*16 (K)	BOLT FLANGE 6*16 (K)	2	
	95701-06050	95701-06050-06	BOLT FLANGE 6*50 (G)	BOLT FLANGE 6*50 (G)	2	
	96001-06032	96001-06032-06	BOLT FLANGE 6*32	BOLT FLANGE SH 6*32	2	

F20

Radiator

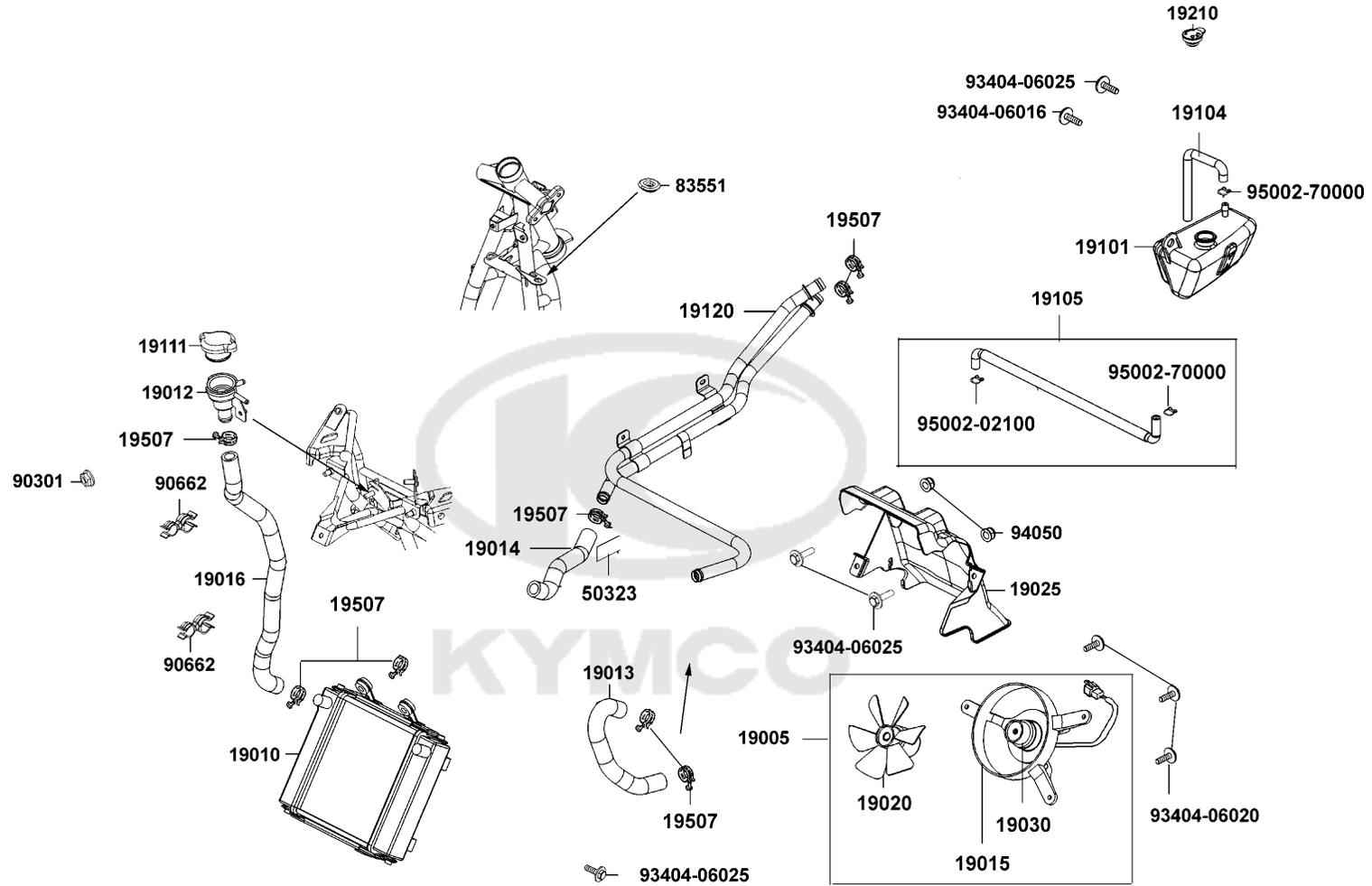



Sales mark	Ref no	Part no	Description	Reg description	Regd no	<b>F20</b>
	19005	19005-LFA7-E00	SHROUD ASSY	SHROUD ASSY	1	
	19010	19010-LHG7-E00	RADIATOR COMP	RADIATOR COMP	1	
	19012	19012-LEA7-E05	UNIT RADIATOR	UNIT RADIATOR	1	
	19013	19013-LHG7-E00	HOSE,WATER INLET	HOSE,WATER INLET	1	
	19014	19014-LHG7-E00	HOSE WATER,OUTLET	HOSE WATER,OUTLET	1	
	19015	19015-LEA5-E00	SHROUD COMP	SHROUD COMP	1	
	19016	19016-LHG7-E00	HOSE WATER-UNIT CAP	HOSE WATER-UNIT CAP	1	
	19020	19020-KED9-900	FAN COOLING	FAN COOLING	1	
**	19025	19025-LHG7-E00	COVER,RADIATOR	COVER,RADIATOR	1	
	19030	19030-KHD8-900	MOTOR ASSY FAN	MOTOR ASSY FAN	1	
	19101	19101-LHG7-E00	TANK , RESERVE	TANK , RESERVE	1	
	19104	19104-LBA2-E00	HOSE ASSY DRAIN	HOSE ASSY DRAIN	1	
	19105	19105-LHG7-E00	HOSE ASSY,RESERVE	HOSE ASSY,RESERVE	1	
	19111	19111-GBE2-004	CAP COMP	CAP COMP	1	
	19120	19120-LHG7-E00	PIPE COMP.,WATER	PIPE COMP.,WATER	1	
	19210	19210-KKC4-900	CAP RESERVE TANK	CAP RESERVE TANK	1	
	19507	19507-LDB5-E00	CLAMP D 28	CLAMP D28	8	
	50323	50323-LHG7-E00	RUBBER FRAME GUARD	RUBBER FRAME GUARD	1	
	83551	83551-KKAK-900	GROMMET AIR CLEANER CASE	GROMMET COVER	1	
	90301	90301-6D34-671	NUT FLANGE 6MM	NUT FLANGE 6MM	1	

F20

Radiator

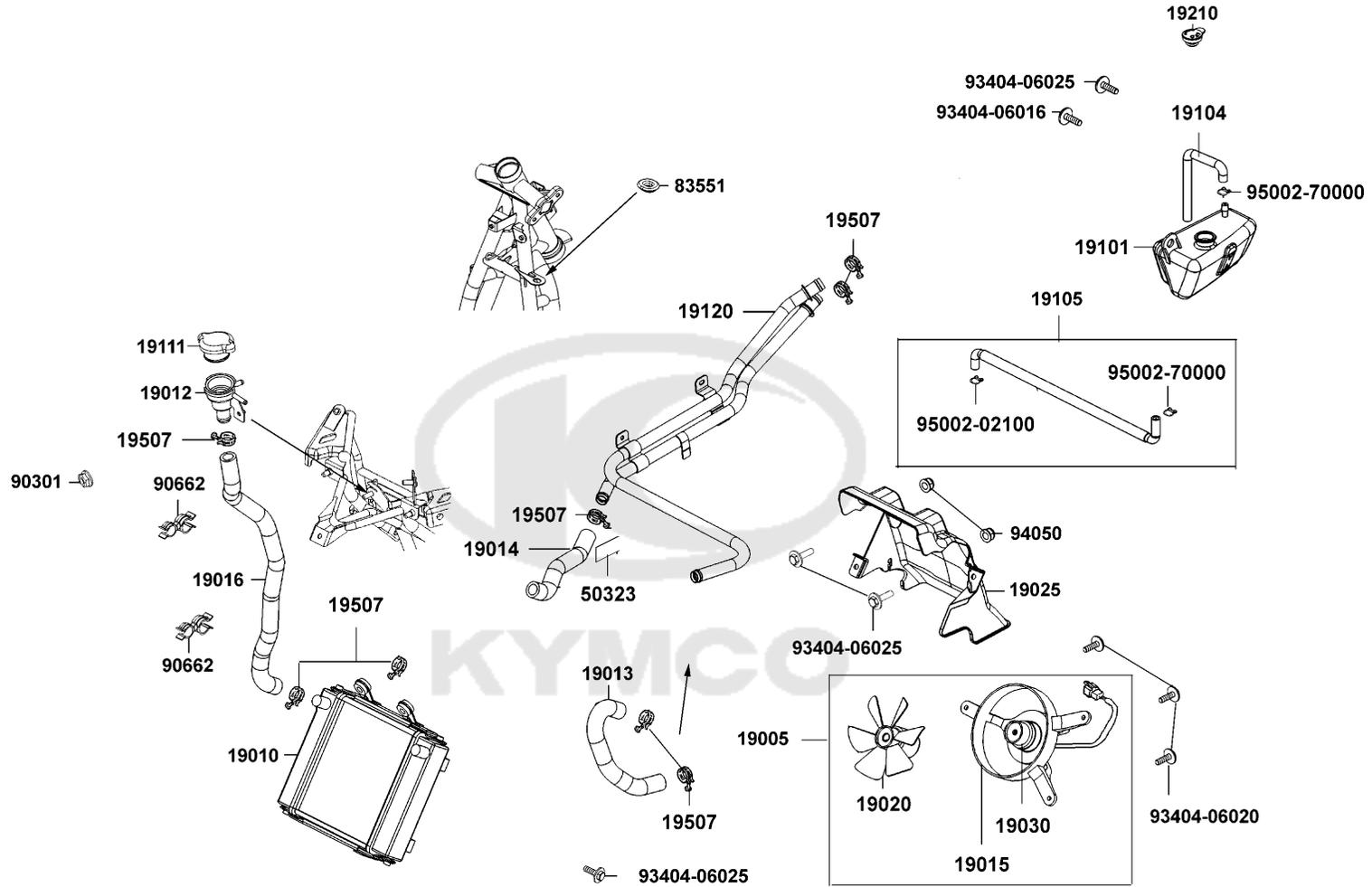

Sales mark	Ref no	Part no	Description	Reg description	Regd no	<b>F20</b>
	90662	90662-LHG7-E00	CLIP,WATER HOSE	CLIP,WATER HOSE	2	
	93404-06016	93404-06016-06	BOLT WASHER 6*16	BOLT WASHER 6*16	1	
	93404-06020	93404-06020-06	BOLT WASHER 6*20 (G)	BOLT WASHER 6*20	3	
	93404-06025	93404-06025-06	BOLT WASHER 6*25	BOLT WASHER 6*25	4	
	94050	94050-06060	NUT FLANGE 6MM	NUT FLANGE 6MM	2	
	95002-02100	95002-02100	CLIP B15 TUBE	CLIP B10 TUBE	1	
	95002-70000	95002-70000	CLIP C11 TUBE	CLIP C11 TUBE	2	
						

F21

Separated Parts Of Fr Fork

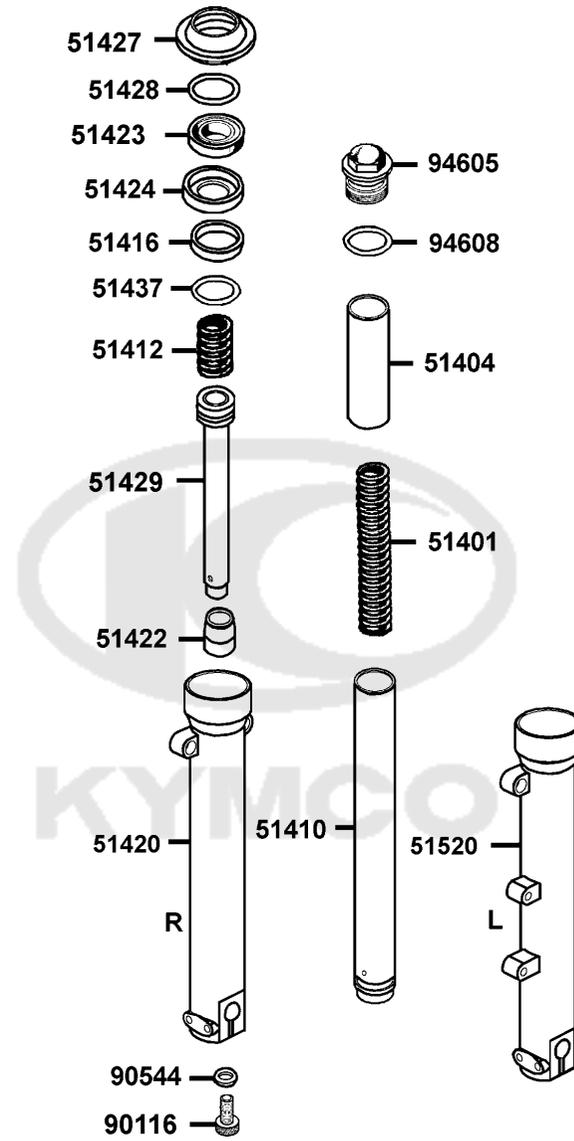

Sales mark	Ref no	Part no	Description	Reg description	Regd no	F21
	51401	51401-LHG7-E00	SPRING	SPRING	2	
	51404	51404-LHG7-E00	SPRING COLLAR	SPRING COLLAR	2	
	51410	51410-LHG7-E00	FORK PIPE COMP	FORK PIPE COMP	2	
	51412	51412-KHD8-900	REBOUND SPRING	REBOUND SPRING	2	
	51416	51416-LHG7-E00	GUIDE BUSH	GUIDE BUSH	2	
**	51420	51420-LHG7-E00	BOTTOM CASE R	BOTTOM CASE R	1	
	51422	51422-KKC4-900	OIL LOCK PIECE	OIL LOCK PIECE	2	
	51423	51423-LHG7-E00	OIL SEAL	OIL SEAL	2	
	51424	51424-LHG7-E00	SPACER	SPACER	2	
	51427	51427-LHG7-E00	DUST SEAL	DUST SEAL	2	
	51428	51428-LHG7-E00	RING OIL SEAL STOPPER	RING OIL SEAL STOPPER	2	
	51429	51429-LHG7-E00	PIPE SEAT COMP	PIPE SEAT COMP	2	
	51437	51437-LHG7-E00	PISTON RING	PISTON RING	2	
**	51520	51520-LHG7-E00	BOTTOM CASE L	BOTTOM CASE L	1	
	90116	90116-LHG7-E00	SOCKET BOLT	SOCKET BOLT	2	
	90544	90544-KEC8-900	PACKING	PACKING	2	
	94605	94605-LHG7-E00	FORK BOLT CAP	FORK BOLT CAP	2	
	94608	94608-LHG7-E00	O-RING	O-RING	2	

Caution Label

● Be sure to wear a safety helmet when riding.  
 ● Do not exceed the speed specified by law when riding.  
 ● The exhaust muffler temperature is very high after riding. Be sure to park the motorcycle in a place not easily touched by people.  
 ● For riding safety and good performance, do not violate the law to modify the motorcycle.  
 ● Please read the User's Manual carefully to secure driving safety.

● Make sure to perform the periodic maintenance and periodic inspection.  
 Periodic Inspection Items  
 Brake Performance, tires, engine oil level, lights, horn, and instrument panel  
 KWANG YANG MOTOR CO., LTD.

87560

**CAUTIONS**

Every 5000 km run should exchange the filter.

KBE-500

87512

**CAUTIONS**

Tire Size (One Rider)	:Front 120/70-13	Rear 140/70-12
(Two Rider)	:Front 1.75kgf/cm <sup>2</sup>	Rear 2.25kgf/cm <sup>2</sup>
	:Front 2.00kgf/cm <sup>2</sup>	Rear 2.50kgf/cm <sup>2</sup>

Load Capacity: Shield 1.5ka Clip assv center 3kg  
 (As per KYMCO standard specification)  
 (Note: The tire pressure must not overpass 2.80kgf/cm)

- Check the motor oil level with the dipstick after refilling motor oil,
- Full Capacity : 1.1 ℓ      Exchange Capacity : 0.9 ℓ

87505

**CAUTIONS**

Before starting the engine, the side stand shall be kicked up to secure safety.

87541-GAR1

**CAUTION**

Mobile phone charge only, Use other appliance may cause damage.

KKC2-E020

87541-KKC2

**CAUTIONS**

Never put any article between the rear side cover and the engine to avoid interference of riding.

GMS-300

87542

Sales mark	Ref no	Part no	Description	Reg description	Regd no	<b>F22</b>
**	87505	87505-LEA5-E00	LABEL TIRE	LABEL TIRE	1	
**	87512	87512-KEBE-E00	CAUTION FILTER	CAUTION FILTER	1	
**	87541-GAR1	87541-GAR1-E00	CAUTION SIDE STAND	CAUTION SIDE STAND	1	
**	87541-KKC2	87541-KKC2-E00	CAUTION MOBILE PHONE	CAUTION MOBILE PHONE	1	
**	87542	87542-GAR1-E00	MARK MAINT CAUTION	MARK MAINT CAUTION	1	
**	87560	87560-GFY6-E00	MARK DRIVE CAUTION	MARK DRIVE CAUTION	1	



*G-DINK 300i*

86202

87140



86102-LGE5



Sales mark	Ref no	Part no	Description	Reg description	Regd no	<b>F23</b>
------------	--------	---------	-------------	-----------------	---------	------------

**	86102-LGE5	86102-LGE5-E00	EMB K-LOGO 20mm	EMB K-LOGO 20mm	1	
**	86202	86202-LHG7-E00	EMB BODY COVER	EMB BODY COVER	2	
**	87140	87140-LHG7-E00	EMB MARK 300i	EMB MARK 300i	1	



## PART NO. INDEX

PART NO.	VERSION	PAGE	PART NO.	VERSION	PAGE	PART NO.	VERSION	PAGE
			11192-KHE7-900	0	E01	12209-GDB4-68A	0	E02
			11200-KKC4-305	2	E01	12209-GDB4-68B	0	E02
			11211-LHG7-E00	0	F13	1221A-LDB2-E00	3	E02
0901-880-6000	0	E08	1122A-LHG7-E00	4	E07	12251-KHE7-901	1	E02
0901-911-6000	0	E08	11235-LHG7-E00	1	E04	12310-LDB2-E00	3	E02
0901-914-6001	0	E08	11330-KHE7-900	6	E04	12361-GFY6-901	1	E04
			11341-LHG7-E00	5	E01	12391-LDB2-E00	1	E02
			11342-LHG7-E00	2	E01			
			11343-LHG7-E00	2	E01	<b>13000</b>		
1090-873-2001	0	E08	11345-LHG7-E00	1	E01			
1190-C74-2000	0	E08	11346-GFY6-901	0	E01	13000-LFG2-E00	6	E03
1190-C75-2000	0	E08	11350-LHG7-E00	2	E01	13011-LHG7-E00	2	E03
1614-868-0000	0	E08	11383-KUDU-900	0	E01	13101-LHG7-E00	4	E03
1614-906-0002	0	E08	11384-KUDU-900	0	F06	13111-LDB2-E00	1	E03
			11387-LHG7-E00	4	E02			
			11387-LHG7-E00	4	E04	<b>14000</b>		
			11391-LHG7-E00	2	E01			
3700-A35B-0100	0	E08	11394-KHE7-900	1	E04	14100-LFG2-E00	2	E02
			11395-KHE7-900	0	E01	14150-LDB2-E00	2	E02
						14401-LDE9-E00	2	E03
			<b>12000</b>			14431-LDB2-E00	1	E02
11100-LDB2-305	0	E01				14450-KEBE-900	0	E02
11102-1G87-004	3	E01	12100-LDE9-E00	3	E03	14452-LDB2-E00	1	E02
11102-1G87-004	3	F16	12191-KHE7-910	2	E03	14510-LDE9-E00	2	E03
11103-KHE7-900	0	E01	12200-LHG7-E00	0	E02	14520-GFY6-90A	1	E03
11110-LLJ3-E00	1	E01	12205-KHE8-301	4	E02	14523-KED9-900	0	E03

## PART NO. INDEX

PART NO.	VERSION	PAGE	PART NO.	VERSION	PAGE	PART NO.	VERSION	PAGE
14531-KHE7-900	1	E03	16211-LDF2-900	1	E02	17689-LHG7-E00	2	F10
14610-LDE9-E00	1	E03				17910-LHG7-E00	3	F03
14711-LFG2-E00	1	E02	<b>17000</b>			17911-LHG7-E00	3	F03
14721-LFG2-E00	1	E02				<b>18000</b>		
14751-KHE7-900	0	E02	17113-LHG7-E00	2	E02			
14761-KHE7-900	0	E02	1711A-LDF2-M90	0	E02			
14771-GDB4-680	2	E02	17208-GAR1-011	0	F13	18291-KKC4-900	1	F14
14775-MFA6-001	0	E02	17214-LLJ3-E00	1	F13	18291-LBA7-900	2	F14
14781-MFA6-001	0	E02	17236-LHG7-E00	4	F13	18292-KEBE-900	0	F14
<b>15000</b>			1723A-LHG7-E00	4	F13	18293-KEBE-900	0	F14
			1723B-LHG7-E00	0	F13	18294-KEBE-900	0	F14
			1723C-LHG7-E00	0	F13	18294-LDB2-900	0	F14
15100-KKC3-900	3	E06	17370-4K19-670	0	F13	18306-LHG7-E00	0	F14
15133-KAM1-001	1	E06	17371-1D74-671	0	F13	1830A-LHG7-E00	5	F14
15141-KKJ9-004	0	E06	1737A-LHG7-E00	3	F13	18310-LHG7-E00	5	F14
15421-1G07-001	1	E04	17500-LHG7-E00	1	F10	18318-LHG7-E00	0	F14
15426-GAE1-921	0	E04	17502-LHG7-E00	0	F10	18320-LHG7-E00	5	F14
15441-1K49-001	0	E03	17504-LHG7-E00	0	F10	18325-LGE5-E00	1	F14
15447-1K49-001	0	E03	17530-LHG7-E00	0	F05	18371-LDB2-E00	1	F14
1565A-LHG7-E00	2	E04	17550-LGE5-E00	1	F10	18391-LDH1-E00	2	F14
15711-KHE7-900	0	E06	17561-LKB9-900	0	F10	<b>19000</b>		
<b>16000</b>			17580-LHG7-E00	1	F10			
			17620-LEA7-315-M1	0	F18	19005-LFA7-E00	2	F20
			17620-LEA7-315-M2	0	F18	19010-LHG7-E00	1	F20
1610K-LHG7-E00	2	E08	17685-KZCZ-900	0	F05	19012-LEA7-E05	1	F20
16201-LHG7-E00	1	E02	17685-LHG7-E00	7	F10			

## PART NO. INDEX

PART NO.	VERSION	PAGE	PART NO.	VERSION	PAGE	PART NO.	VERSION	PAGE
19013-LHG7-E00	0	F20	19507-LDB5-E00	1	E04			
19014-LHG7-E00	1	F20	19507-LDB5-E00	1	F20	<b>23000</b>		
19015-LEA5-E00	1	F20						
19016-LHG7-E00	1	F20	<b>21000</b>			2301A-LHG7-E80	2	E05
19020-KED9-900	1	F20				23100-LHG7-E00	0	E05
19025-LHG7-E00	0	F20	21200-KHE7-305	0	E07	23200-KHE7-900	6	E05
19030-KHD8-900	2	F20	21395-KHE7-900	0	E07	23220-LFG2-E00	2	E05
19101-LHG7-E00	0	F20				23225-KHE7-900	0	E05
19104-LBA2-E00	1	F20	<b>22000</b>			23226-GHC8-004	0	E05
19105-LHG7-E00	0	F20				23233-KHE7-900	1	E05
19111-GBE2-004	1	F20	22101-KHE7-900	1	E05	23237-KHE7-900	0	E05
19120-LHG7-E00	5	F20	22102-KHE7-900	3	E05	23238-KHE7-900	0	E05
19210-KKC4-900	0	F20	22105-LHG7-E00	0	E05	23411-KHE7-900	3	E07
19215-LHG7-E00	2	E04	22110-LFG1-E00	2	E05	23420-KHE7-910	1	E07
19217-6G57-024	0	E04	22112-KHE7-900	1	E05	23431-KHE7-900	2	E07
19220-LHG7-305	0	E04	22121-KHE7-90A	1	E05	23432-KHE7-910	0	E07
19229-KHE7-900	0	E04	22131-LBA7-900	1	E05			
19231-KKJ9-011	0	E04	22132-KHE7-900	2	E05	<b>28000</b>		
19300-KAE1-004	1	E02	22300-LHG7-E80	1	E05			
19310-LDF2-900	2	E02	22350-KHE7-900	1	E05	28101-KHE7-900	0	E06
19315-LDB2-E00	1	E02	22361-LEA7-E00	1	E05	28102-KHE7-900	0	E06
19501-LHG7-E00	4	E04	22401-KHE7-900	2	E05	28110-LDB2-E00	4	E06
19502-KHE7-900	0	E04	22530-LFG2-E80	1	E05	28120-LDB2-E00	0	E06
19503-LHG7-E00	3	E02	22804-GBB2-001	0	E05			
19505-LEA2-900	1	F10						
19507-LDB5-E00	1	E02						

## PART NO. INDEX

PART NO.	VERSION	PAGE	PART NO.	VERSION	PAGE	PART NO.	VERSION	PAGE
			32412-LKB9-900	0	E04	34905-LHG7-E00	0	F01
			32413-LHG7-E00	0	F11	34906-KPCP-900	0	F17
<b>30000</b>			<b>33000</b>			<b>35000</b>		
3051A-LEK1-E01	1	F18						
30700-LKG2-910	1	F18						
<b>31000</b>			33100-LHG7-E00	1	F01	35010-LHG7-315-M1	0	F18
			33101-LHG7-E00	0	F01	35010-LHG7-315-M2	0	F18
			33120-LHG7-E00	0	F01	35101-LHG7-315-M1	1	F18
31110-LHG7-E00	1	E06	33400-LHG7-E00	0	F03	35101-LHG7-315-M2	1	F18
31120-LHG7-E00	3	E06	33450-LHG7-E00	0	F03	35102-LDH1-E0A	0	F18
31205-KKJ9-000	0	E06	33700-LHG7-E00	2	F17	35102-LDH1-E0B	0	F18
31210-KHE7-90A	1	E06	33708-KHE7-E00	0	F17	35111-KHC5-305-M1	0	F18
31340-LHG7-E00	2	F07	33709-KHE7-E00	0	F17	35111-KHC5-305-M2	0	F18
31500-LEA6-900	3	F11	33720-LBB5-E00	3	F17	35111-KHC5-306-M1	0	F18
31500-LEA6-90B	1	F11	33726-LBB5-E00	1	F17	35111-KHC5-306-M2	0	F18
31600-LHG7-E00	0	F18	33741-KHC5-M00	0	F17	35119-LEB1-90A	0	F18
31601-LEA7-E00	1	F18	33900-LHG7-E00	0	F12	35119-LEB1-90B	0	F18
3195A-LEA7-E05	1	F18	33901-LHG7-E00	0	F12	3515A-LHG7-E00	1	F03
<b>32000</b>			33902-LHG7-E00	0	F12	3520A-LHG7-E00	1	F03
			33903-LHG7-E00	0	F12	35340-KNBN-901	0	F04
			<b>34000</b>			35350-KNBN-901	0	F04
32100-LHG7-E00	7	F18				35370-LLJ3-E00	3	F15
32101-LEA7-E00	1	E02				35380-LKG2-900	1	F18
32311-LHG7-E00	1	E02	34901-KED9-900	0	F01	35390-LHG7-E00	0	F12
32410-LHG7-E00	1	E06	34903-KPCP-900	0	F17	35850-KHB4-90A	2	F18
32411-LHG7-E00	1	F11	34905-LCA5-E00	0	F17	35850-KHB4-90B	3	F18



## PART NO. INDEX

PART NO.	VERSION	PAGE	PART NO.	VERSION	PAGE	PART NO.	VERSION	PAGE
45132-LDH1-E00	0	F08	50350-LHG7-E00	3	F19	51404-LHG7-E00	0	F21
45134-KED9-900	0	F07	50352-LBA2-E00	1	F19	51410-LHG7-E00	0	F21
45200-LEA7-E00	7	F07	50353-KGN7-901	0	F19	51412-KHD8-900	0	F21
45209-GBN2-007	0	F08	50353-LEA7-E00	1	F19	51416-LHG7-E00	0	F21
45209-KED9-900	0	F07	50356-LFA7-E01	1	F19	51420-LHG7-E00	0	F21
45210-LDF2-E00	0	F08	50356-LHG7-E00	0	F19	51422-KKC4-900	0	F21
45210-LEA7-E00	0	F07	50360-LHG7-E00	2	F19	51423-LHG7-E00	0	F21
45351-LEA5-E00	2	F07	50364-KHE7-E00	0	F19	51424-LHG7-E00	0	F21
45513-KHD4-B00	2	F04	50500-LHG7-E00	2	F15	51427-LHG7-E00	0	F21
45517-KFAF-910	0	F04	50502-LDF7-E10	0	F15	51428-LHG7-E00	0	F21
45520-GLW0-91A	0	F04	50504-LHG7-E00	2	E01	51429-LHG7-E00	0	F21
45530-LHG7-305	0	F04	50505-KUDU-900	1	F15	51430-LDH1-E00	0	F08
45531-GAR1-951	0	F08	50505-LEA7-E00	0	F15	51437-LHG7-E00	0	F21
45531-KED9-900	0	F07	50506-KHE7-E00	0	F15	51500-LHG7-E00	8	F06
			50530-LHG7-E00	1	F15	51520-LHG7-E00	0	F21
<b>50000</b>			50550-KKC2-E00	0	F15			
			50613-LHG7-E00	0	F19	<b>52000</b>		
50100-LHG7-E00	3	F19	5071A-LDC1-91A	1	F19			
50144-LHG7-E00	2	F19	5071A-LDC1-91B	1	F19	52000-LHG7-E00	7	F16
50154-KKE3-900	2	F18	5071B-LDC1-91A	1	F19	52104-LGE5-E01	0	F06
50179-LHG7-E00	1	F10	5071B-LDC1-91B	1	F19	52400-LHG7-E00	5	F16
50189-LHG7-E00	0	F19				52500-LHG7-E00	6	F16
50306-1F96-001	0	F06	<b>51000</b>					
50323-LHG7-E00	0	F20				<b>53000</b>		
5032A-LEA5-E00	3	F11	51400-LHG7-E00	6	F06			
5032A-LEA7-E00	2	F11	51401-LHG7-E00	0	F21	53100-LHG7-E00	0	F03

## PART NO. INDEX

PART NO.	VERSION	PAGE	PART NO.	VERSION	PAGE	PART NO.	VERSION	PAGE
53102-KEC8-900	0	F03				64310-LHG7-E00	4	F05
53105-LBB5-E00	2	F03	<b>61000</b>			64311-LHG7-E00	1	F05
53125-LEA7-E00	2	F03				64315-LHG7-E00	2	F19
53140-KKC4-900	0	F03	61100-LHG7-E00	2	F06	64316-LHG7-E00	2	F19
53166-KGB5-900	0	F03	61110-LHG7-E00	2	F05	64317-LHG7-E00	0	F05
53175-LEA5-E00	1	F04				64320-LHG7-E00	1	F05
53178-LEA5-E00	1	F04	<b>64000</b>			64330-LHG7-E00	1	F05
53200-LKG3-E00	0	F06				64400-LHG7-E00	0	F05
53203-LHG7-E00	0	F03	64220-LHG7-E00	0	F03			
53204-LHG7-E00	5	F03	64221-LEA7-E00	2	F03	<b>77000</b>		
53205-LHG7-E00	2	F03	64222-LEA7-E00	2	F03			
53206-LHG7-E00	2	F03	64222-LLJ3-E00	1	F03	77106-KKE5-E00	1	F12
53207-LHG7-E00	0	F03	64222-LLJ3-E00	1	F06	77107-KKE5-E00	1	F12
53213-LBA2-E00	2	F06	64223-LEA7-E00	5	F03	77200-LHG7-E00	1	F09
53214-LBA2-E00	2	F06	64224-LEA7-E00	1	F03	77206-KEB7-900	0	F09
53214-LHG7-E00	0	F06	64225-LEA7-E00	2	F03	77210-LHG7-E00	0	F12
53220-LBA2-E00	2	F06	64226-LEA7-E00	2	F03	77235-LEA1-900	4	F18
53240-LBA2-E00	2	F06	64301-LHG7-E00	4	F05	77240-LHG7-E00	3	F18
53250-LBA2-E00	2	F06	64302-LHG7-E00	1	F05	77300-LHG8-E00	1	F09
			64303-LHG7-E00	1	F05	77303-LCD3-E00	1	F09
<b>55000</b>			64304-LHG7-E00	4	F05			
			64305-LHG7-E00	1	F05	<b>80000</b>		
55122-LHG7-E00	0	F05	64306-LHG7-E00	1	F05			
			64307-LHG7-E00	0	F05	80100-LHG7-E00	3	F17
			64308-LHG7-E00	0	F05	80101-LHG7-E00	4	F17
			64309-LHG7-E00	1	F05	80103-LHG7-E00	0	F17



## PART NO. INDEX

PART NO.	VERSION	PAGE	PART NO.	VERSION	PAGE	PART NO.	VERSION	PAGE
80104-LHG7-E00	0	F17				87505-LEA5-E00	1	F22
80105-LHG7-E00	5	F17	<b>83000</b>			87508-KKC4-E00	1	F03
80107-LEA7-E00	3	F17				87512-KEBE-E00	0	F22
80108-LEA2-900	0	F17	83500-LHG7-E00	1	F12	87541-GAR1-E00	1	F22
80151-LHG7-E00	0	F12	83510-LHG7-E00	1	F12	87541-KKC2-E00	1	F22
80152-LHG7-E00	0	F05	83520-LHG7-E00	1	F05	87542-GAR1-E00	2	F22
80153-LEA7-E00	3	F05	83530-LHG7-E00	0	F12	87560-GFY6-E00	3	F22
80154-LHG7-E00	0	F05	83550-KEC8-900	0	F06	87700-LBD5-E40	0	F12
<b>81000</b>			83551-KEC8-900	0	F06			
			83551-KED9-900	2	F05	<b>88000</b>		
			83551-KKAK-900	0	F20			
81131-LHG7-E00	1	F05	83600-LHG7-E00	1	F12	88110-LHG7-E00	1	F03
81133-LHG7-E00	0	F05	83610-LHG7-E00	1	F12	88115-LBA2-E02	1	F03
81136-LHG7-E00	0	F05	83620-LHG7-E00	1	F05	88120-LHG7-E00	1	F03
81137-LHG7-E00	1	F05	83630-LHG7-E00	0	F12			
8113A-LHG7-E00	3	F05	83750-LHG7-E00	0	F12	<b>89000</b>		
81160-LHG7-E00	1	F05	8376A-KEBE-900	4	F05			
81210-LHG7-E00	1	F12				89010-LHG7-E00	0	F09
81220-LHG7-E00	1	F12	<b>86000</b>					
81251-LHG7-E00	0	F12				<b>90000</b>		
81252-LEA7-E00	1	F12	86102-LGE5-E00	1	F23			
81252-LHG7-E00	0	F12	86202-LHG7-E00	1	F23	90001-GBHB-661	2	E03
81253-LHG7-E00	3	F12				90001-GBHB-661	2	E06
81260-LHG7-E00	0	F12	<b>87000</b>			90005-KEC8-900	3	E03
						90012-3C33-001	2	E02
			87140-LHG7-E00	2	F23	90031-KEBE-900	0	E01

## PART NO. INDEX

PART NO.	VERSION	PAGE	PART NO.	VERSION	PAGE	PART NO.	VERSION	PAGE
90031-KKA7-900	0	E01	90122-LHG7-E00	2	F08	90304-GHE8-004	0	F03
90033-GFY6-900	0	E02	90125-05010-0D	0	E04	90304-GHE8-004	0	F16
90071-MLB0-001	0	E06	90131-KFAF-900	2	F16	90304-GHE8-004	0	F19
90084-4H28-001	0	E04	90145-MKS9-61A	1	F04	90304-LBD4-900	2	F19
9008A-KHE7-900	0	E04	90201-KHE7-900	1	E05	90305-KFW6-91A	1	F08
90101-LEA7-E00	1	F14	90201-KHR8-75A	1	E05	90305-LBA2-E00	1	F06
90103-LEA7-E00	1	F14	90201-KHR8-75A	1	E06	90305-LBD4-900	1	F19
90105-KCR3-001	1	F07	90202-1G87-001	0	E05	90312-LLJ3-E00	1	F03
90105-KCR3-001	1	F08	90206-0A01-001	2	E02	90312-LLJ3-E01	0	F06
90105-KHB4-900	0	F03	90215-KKC4-900	1	F12	90401-KKJ9-001	0	E05
90106-GEN5-901	0	F03	90301-6D34-671	1	F01	90401-KKJ9-001	0	E06
90106-KFAF-900	2	F12	90301-6D34-671	1	F17	90423-KKJ9-001	0	E04
90106-KFC2-900	0	F03	90301-6D34-671	1	F20	90441-KKC4-800	0	E05
90106-KKD6-E00	0	F12	90301-GFY6-901	2	F14	90465-MDC4-001	0	E02
90106-LEA7-E00	1	F19	90302-GFY6-901	1	F05	90474-3C33-001	1	E01
90107-LEA7-E00	3	F03	90302-GFY6-940	1	F11	90478-7L00-001	0	E02
90107-LEA7-E00	3	F06	90302-GFY6-940	1	F12	90503-LEA7-E00	2	F06
90108-KKC4-900	1	F15	90302-KFC2-900	1	F16	9052A-GFY6-950	3	E01
90111-KKD7-900	1	F17	90302-KFC2-900	1	F17	90544-KEC8-900	0	F21
90112-KNBN-901	1	F11	90302-LBF2-900	1	F06	90545-3L00-001	2	F04
90114-1F66-007	2	F04	90302-LKB9-900	1	F03	90605-1F66-721	0	E05
90114-LBA2-E00	1	F12	90302-LKB9-900	1	F05	90651-LGE5-E00	1	F10
90115-KXCX-900	1	F13	90302-LKB9-900	1	F12	90651-LGM9-900	1	F05
90116-LHG7-E00	0	F21	90302-LKB9-900	1	F19	90651-LHG7-E00	0	F18
90117-KED9-900	1	F19	90302-LLB1-E00	2	F03	90651-LKE6-900	0	F17
90122-LEA7-E00	1	F07	90302-SDA4-004	2	F05	90651-LKE6-900	0	F18

## PART NO. INDEX

PART NO.	VERSION	PAGE	PART NO.	VERSION	PAGE	PART NO.	VERSION	PAGE
90652-GFY6-901	1	E02	91202-KKC4-900	0	E01	92101-05032-0H	0	E06
90652-KHE7-900	0	F13	91202-KKC4-90B	1	E01	92900-06050-0B	0	E02
90652-LCA4-E00	1	F05	91202-LHG7-E00	1	E01			
90652-LFB5-900	2	F05	91211-KHE7-900	0	E05	<b>93000</b>		
90656-KCBC-900	0	F03	91255-KHE7-900	0	E01			
90656-KCBC-900	0	F18	91255-KHE7-900	0	E07	93401-06022-07	0	F14
90656-KUDU-900	0	F03	91255-LGE5-E00	1	F16	93404-06016-06	0	F03
90656-KUDU-900	0	F18	91255-LLB1-900	1	F16	93404-06016-06	0	F05
90660-KNBN-921	0	F13	91301-KHE7-900	0	E02	93404-06016-06	0	F12
90660-PWA2-900	1	F03	91301-LDF2-M90	2	E02	93404-06016-06	0	F15
90662-LHG7-E00	0	F20	91302-0A01-021	0	E04	93404-06016-06	0	F19
90677-GAR1-004	1	F11	91302-KHE7-900	0	E04	93404-06016-06	0	F20
90677-GAR1-004	1	F17	91302-LDB2-E00	1	E02	93404-06020-06	1	F20
90754-LLJ3-E00	1	F07	91302-LDF2-M90	2	E02	93404-06025-06	0	F03
90914-LHG7-E00	2	E02	91303-3G77-001	0	E04	93404-06025-06	0	F05
<b>91000</b>			91306-1E05-691	0	E03	93404-06025-06	0	F20
			91307-0E35-001	0	E04	93500-03010-1A	0	E06
			91309-4E25-004	0	E06	93500-05016-0H	0	E02
91001-KHE7-900	0	E03	91351-KHE7-900	0	E05	93500-05016-0H	0	E06
91001-KHE7-90A	0	E03	91407-SGA7-004	0	F13	93500-05016-1B	0	F03
91001-KKJ9-006	0	E04	91507-LKE6-900	0	F06	93500-05025-1B	0	F03
91002-GGA7-70A	0	E05				93500-05032-1B	0	F03
91003-KHE7-900	0	E01	<b>92000</b>			93500-05045-1B	0	F03
91004-KHE7-900	1	E05				93500-KHC4-90A	0	F18
91009-KHE7-900	0	E07	92000-05012-0H	0	E01	93600-04012-1G	0	F04
91201-KKJ9-004	0	E04	92101-05008-0A	0	E01	93891-05016-00	0	F13

## PART NO. INDEX

PART NO.	VERSION	PAGE	PART NO.	VERSION	PAGE	PART NO.	VERSION	PAGE
93892-04008-18	0	E08	94050-06060	0	F19	94591-KFBF-900	2	E02
93893-04012-18	0	F04	94050-06060	0	F20	94601-17000	0	E03
93903-25360	0	F02	94050-06080	0	E02	94601-33000	0	E05
93903-25460	0	F13	94050-06080	0	F09	94605-LHG7-E00	0	F21
93903-34260	0	F03	94050-06080	0	F18	94608-LHG7-E00	0	F21
93903-34360	0	F17	94050-08080	0	E02			
93903-35260	0	F01	94101-05800	0	E04	<b>95000</b>		
93903-35260	0	F03	94101-08600	0	F15			
93903-35260	0	F05	94101-LBA2-E00	1	F19	95002-02070	0	E02
93903-35260	0	F12	94101-LEA2-900	0	F14	95002-02080	0	F05
93903-35260	0	F17	94102-LBA2-E00	1	F19	95002-02100	0	F20
93903-45260	0	F03	94111-05800	0	E06	95002-02130	0	F10
93903-45260	0	F05	94251-08400	0	F15	95002-41100-04	0	F13
93903-45260	0	F12	94301-08140	0	E04	95002-50000	0	E07
93903-45260	0	F17	94301-10160	0	E01	95002-70000	0	F20
93903-45260	0	F19	94301-10160	0	E02	95003-23036-60	0	F13
93903-GFY6-900	1	F05	94301-10160	0	E03	95014-72204	0	F15
93903-KEB7-900-06	1	F03	94301-10160	0	E04	95701-06012-06	1	F19
			94301-10160	0	E07	95701-06012-08	0	E02
<b>94000</b>			94303-04065	0	E06	95701-06016-06	1	F19
			94401-25140	4	E03	95701-06025-06	2	F14
94050-05080	0	F17	94510-10000	0	E06	95701-06025-08	0	E02
94050-05080	0	F18	94510-25000	0	E07	95701-06028-08	0	E02
94050-06060	0	F04	94520-26000	0	E04	95701-06030-06	0	F06
94050-06060	0	F10	94520-28000	0	E05	95701-06050-06	0	F19
94050-06060	0	F18	94520-47000	0	F16	95701-08012-06	0	F18

## PART NO. INDEX

PART NO.	VERSION	PAGE	PART NO.	VERSION	PAGE	PART NO.	VERSION	PAGE	
95701-08012-08	0	E01	96001-06032-08	0	E01	<b>K</b>  K536-174-0200			
95701-08016-06	0	F12	96001-06045-08	0	E04				
95701-08030-08	0	E07	96001-06050-08	0	E01				
95701-08035-08	0	E07	96001-06110-08	0	E02				
95701-LDF2-800	2	F10	96001-06125-08	0	E04				
95701-LEA5-E00	1	F18	96100-60000-00	0	E04				
95801-08040-06	0	F06	96100-63020-00	0	E01				
95801-10030-06	0	F15	96100-63020-00	0	E07				<b>N</b>  N114-05103-3
95801-10035-06	0	F16	96100-63040-00	1	E01				
95801-10040-06	0	F16	96150-60020-10	0	F07				
95801-10060-06	0	F14	96150-62040-10	0	F16	<b>W</b>  W1792-048-9901			
<b>96000</b>			96220-20118	0	E03				
			96600-08015-10	1	E06				
			96600-08025-06	0	F06				
96001-06012-08	0	E06							
96001-06012-08	0	F16	<b>98000</b>						
96001-06012-08	0	F18							
96001-06016-08	0	E01	98069-5691R-00	0	E02				
96001-06018-02	0	E04	98200-31000	1	F11				
96001-06018-08	0	E02	98200-31000	1	F18				
96001-06020-08	0	F13	98200-31500	0	F11				
96001-06022-06	1	F04	98200-31500	0	F18				
96001-06022-08	0	E04	98200-33000	0	F11				
96001-06028-08	0	E04	98200-33000	0	F18				
96001-06028-08	0	E06							
96001-06032-06	0	F19							